



Open your dreams... and find your style

Nowadays, we live in a constant rush, trying to find peace, beauty, and a safe refuge at home and other places where we spend our time. A sense of security and harmony improves the everyday quality of life. INVADO understands and respects those needs. Being one of the most rapidly developing manufacturers of door joinery and skirting boards in Poland, we do our best to give you products that meet your needs, with high, individual aesthetics, and the best possible functional features. Our market position is built on over thirty years of experience and continuous investment in technology, people, and quality improvement.

www.invado.pl

A photograph of the INVADO building, a modern structure with a glass facade and a brick tower. The INVADO logo is visible on the glass part of the building. In the foreground, there are several cars parked in a lot.

24 months of warranty
on INVADO products

Quality above all

The belief that quality is of the utmost importance remains the common denominator of the design phase and the entire production process at INVADO. This is confirmed, among others, by the ISO 9001 Certificate, which ensures that all our products meet high European standards. The guarantee of the quality of products and services, in addition to the price and timeliness of deliveries, is the basic goal of the company, enabling it to be perceived as a trusted partner.

INVADO Technology

Production of door leaves and door frames is the strongest point of our INVADO offer, therefore the implementation of innovative production technology of foiled doors (INVADO Technology) became a breakthrough in the Company's activity. The most distinct feature of this technology is foiling surfaces without connecting foil on rebate edges. Because of this method, the edge of a door leaf looks aesthetically clean and is also more resistant to damage. It's very unlikely to break off the foil because it ends in the inner corner of the rebate—invisible to the eye. "Technology of foiling flat doors in the mass production system" has been in use since 2007 when it comes to all foiled doors. In addition—off-rebate foiling creates rounded edges in INVADO door leaves, safe for the hands of adults and children. Nowadays, thanks to the innovative method of door production, INVADO is among the most technologically advanced companies in Europe.

Hygienic certificates

Hygienic certifications aim to prevent materials and products hazardous to health and life to be introduced to the public or limit the acceptable range and application methods to eliminate health risks. All INVADO products have hygienic certificates:

- interior door frames in artificial veneer No. **441/322/451/2017**
- interior door leaves in artificial veneer or flat lacquered No. **348/322/353/2020**
- skirting boards in artificial veneer No. **256/322/261/2019**

Technical Approvals and National Technical Assessments

Technical Approvals and National Technical Assessments, issued by the Building Research Institute, are decisions that grant the use of building materials and products. In accordance with the Construction Products Act of April 16th 2004, as amended (unified text: Journal of Laws of 2016, item 1570), the products to which the Technical Approvals and National Technical Assessments relate, may be placed on the market and can be used in construction. INVADO Company assessed and verified the constancy of performance, made a national declaration of performance, and labeled the products with a construction mark in accordance with applicable regulations. INVADO's Technical Approvals and National Technical Assessments:

- Interior flat and glass doors—**ITB-KOT-2017/0313** edition 2;
- Modular interior doors—**ITB-KOT-2017/0003** edition 2;
- Folding, swinging, and sliding interior doors—**ITB-KOT-2018/0296** edition 1;
- Technical doors GUARDIA EI₂30 and EI₂60 (wooden interior entrance doors of HALSPAN system)—**ITB-KOT-2018/0407** edition 1; National Certificate of Stable Performance **AC 158-UWB-W1355**;
- Technical doors IGNIS—National Certificate Of Stable Performance **AC 158-UWB-W3479**;
- Interior entrance doors EGIDA with increased resistance to breaking-in—**ITB-KOT-2018/0598** edition 1;
- Adjustable door frames for interior doors—**ITB-KOT-2019/1221** edition 2;
- Block door frames for interior doors OB3 type P—**ITB-KOT-2017/0312** edition 2;
- Door frames SARA-PRO for interior doors—**ITB-KOT-2019/1076** edition 1;
- Metal door frames—**ITB-KOT-2021/2091** edition 1;
- Housing system for metal door frames—**ITB-KOT-2019/1221** edition 1.

CERTIFICATES AND AWARDS



BRAND OF THE DECADE 2009–2019 GOOD BRAND 2019 and 2021

An independent group of experts confirmed that products bearing the INVADO logo are characterized by: quality, trust, and reputation, awarding our company the title of BRAND OF THE DECADE 2009-2019 and the titles of GOOD BRAND 2019 and GOOD BRAND 2021. We would like to thank our customers for the trust you place in us by choosing INVADO doors for their dream interiors, our Business Partners for fruitful cooperation, recommending, and support, and all INVADO Employees for jointly building a good brand at every stage of its creation. We are incredibly grateful that our hard work is appreciated and we look forward to the future with pride.



CONSUMER'S LAUREL

INVADO brand has been recognized by Polish consumers and honored with the prestigious Consumer's Laurel emblem.



VOC

The VOC certification tests the emission of volatile organic compounds released from the facility and, depending on the results obtained, the tested sample is assigned a class, ranging from A+ (best) to C (worst). The possession of the VOC certificate confirms that the product does not release harmful to health substances inside the house, such as formaldehyde and benzene—carcinogenic elements that unfortunately are often contained in paints, and materials used on windows.



ISO 9001

The INVADO Company applies to the Quality Management System and fulfills the requirements of PN-EN ISO 9001 in the scope of designing, production, and sale of furniture components and finishing profiles, interior doors made of wood and wood-based materials, and technical doors.



FSC™

Control of Product Origin and environmental protection are the leading elements of INVADO's development strategy. This is confirmed by an international certificate issued by the Forest Stewardship Council™ and obtained by the company in 2007.

Ask for FSC™ certified products in our range.



CERTIFICATE RESOURCES SAVED

INVADO has obtained the international certificate in waste management and recycling issued by INTERSEROH zero waste solutions.

AVANT-GARDE STYLE

MILLED

DOORS

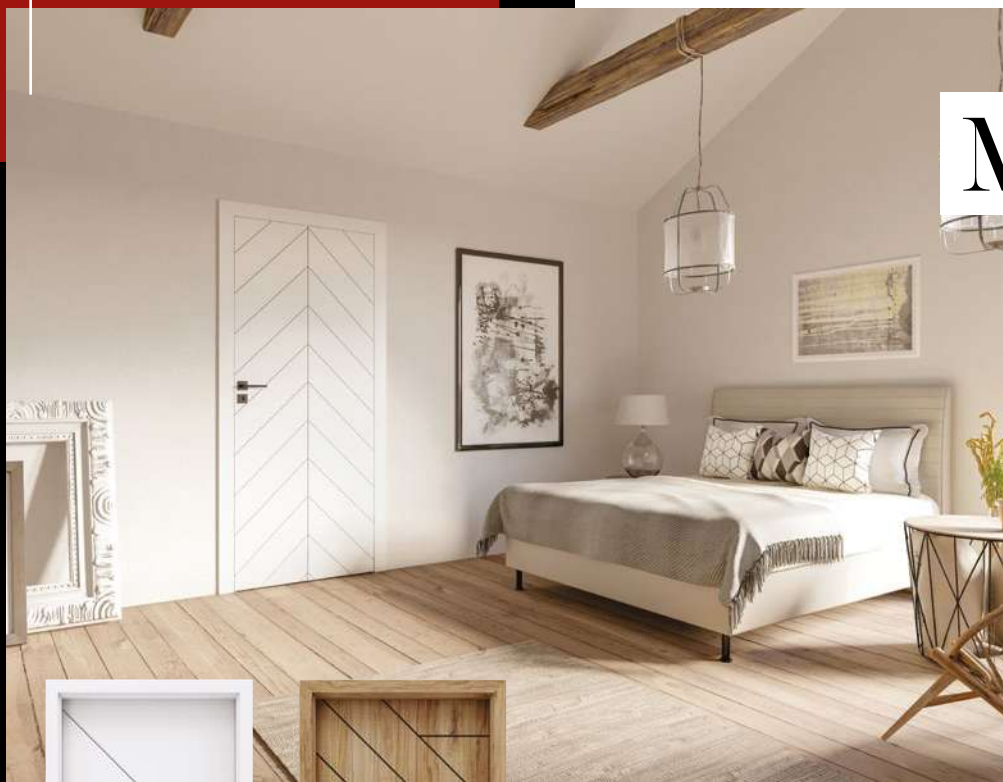

We invite you to interiors inspired by **INVADO milled doors**. We present a harmonious combination of classics and modern design solutions—the **Belgatto** and **Decorato** collections. Mills—previously associated rather with classic design—have gained a completely new, fresh character, thanks to our designers. We recommend them for interiors where there is no room for boredom and clichéd arrangement ideas.

the Belgatto and Decorato collection

DECORATO 12



PAGE 90

BELGATTO 14



PAGE 88

With a black dot above the "i"

serves as an original decorative form, will be perfect as an arrangement of the dot above the "i". It perfectly corresponds with both the timeless white veneer, the classic color of European Oak, and Naturo Oak for those who miss the retro or fusion style.

You don't need much to create an interior with character. The door with a **black panel**, which

BLACK PANEL IN CORATO, AVERSA, TAMPARO, AND LINEA FORTE DOOR LEAVES



NEW POLYPROPYLENE DECOR GROUP

pure graphite

pure black

pure white

catania oak

narbonne oak

- ELEGANT, MATT FINISH
- RESISTANT TO SCRATCHES
- HIGH QUALITY AT A **DECENT PRICE**
- EASY TO MAINTAIN
- LOWER SUSCEPTIBILITY TO FINGERPRINTS
- GREATER COLOUR DEPTH
- FORMALDEHYDES **FREE**

flagstaff oak

LAMINOLACK

door frame
ORS4 90°

STR. 127

Table of contents

GOOD TO KNOW	8–10
GLASS TYPES	11
DECOR PALETTE	12–15
COLLECTION OF MODULAR DOORS	16–57
COLLECTION OF FOILED DOORS	58–85
MODERN AND OPTIMO LINE COLLECTION	86–107
COLLECTION OF GLASS DOORS	108
COLLECTION OF FOLDING DOORS	110
SLIDING SYSTEMS	
POCKET DOOR sliding system	112
WALL-MOUNTED sliding system	114
TECHNICAL DOORS	
EGIDA interior entrance doors	116
IGNIS fire doors	118
GUARDIA fire doors	120
TECHNICAL INFORMATION	122
DOOR FRAMES	
BLOCK door frame	125
ADJUSTABLE door frame (REBATED)	126
ADJUSTABLE door frame (NON-REBATED)	127
METAL door frames	128
Concealed door frame SARA-PRO	130
Housing system for metal door frames	132
ACCESSORIES	133–135
HANDLES	136
SKIRTINGS	138



COLLECTION OF **FOILED** DOORS

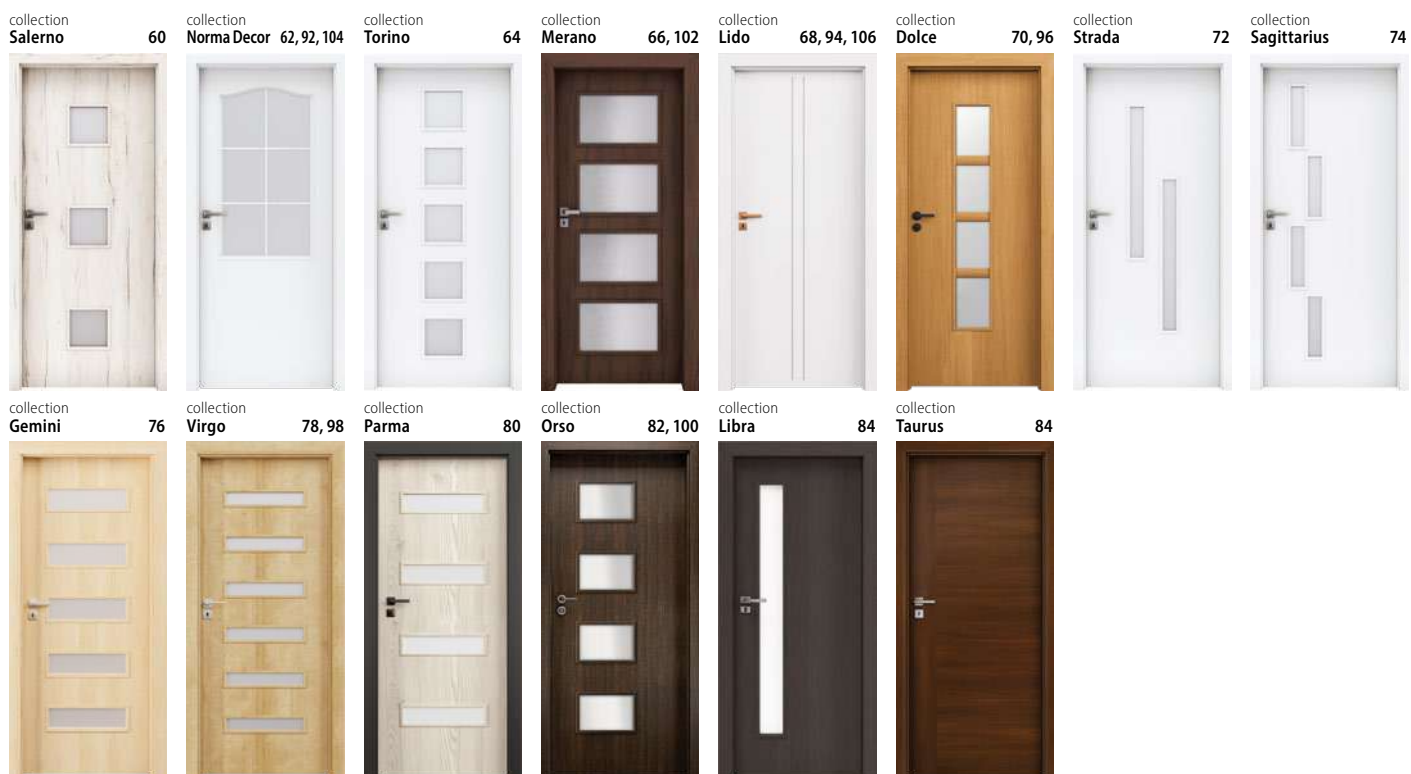

FOILED AND MODULAR DOORS

FOILED DOORS

Visually, **foiled doors** are lighter than modular ones, which is combined with their stability. Their construction is a frame made of MDF board with a "honeycomb" or tubular chipboard (charged extra) filling. The frame with the filling is covered with a 3 mm-thick HDF board from both sides and wrapped with a decorative foil. The glazing beads of different profiles are used to hold the filling elements in these doors.

16 DOOR collections **40** colours of VENEERS **88** LEAVES in total

SAFE DESIGN
depending on the collection, rounded "soft" edges or sharp "cut edges"

RESISTANCE TO LOAD
2 or 3 (starting from width "90")
screw-in pivot hinges

STANDARD FILLING
"Honeycomb" (cardboard)

OPTIONAL FILLING AT EXTRA CHARGE
Tubular chipboard

FOIL CONNECTION IN THE REBATE
Innovative "soft" technology of foiling

FLAT CONSTRUCTION
Glazing beads

Frosted SATINATO
glass

Wide selection of HANDLES

VENTILATION
Ventilation sleeves, undercut or grid*
(*NORMA DECOR door leaves only)

www.invado.pl

MODULAR DOORS

Construction of **modular doors**: two vertical elements, upper and lower horizontal elements. Filling: MDF panels of different thicknesses or glass 4 mm-thick. For each model you can select a decorative foil. Glass and other filling elements in these door leaves are not installed using glazing beads, but with all the construction elements at once, which greatly improves their stability.

21 DOOR collections **24** colours of VENEERS **110** LEAVES in total

STRONG MODULAR CONSTRUCTION
No glazing beads

Wide selection of HANDLES

OPAQUE GLASS INSERT

VENTILATION
Undercut, round or square metal sleeves

ROUNDED EDGES
Safe design

DOOR LEAF FILLING
22 mm-thick MDF boards

Frosted SATINATO
glass

RESISTANCE TO LOAD
2 or 3 (starting from width "90")
screw-in pivot hinges

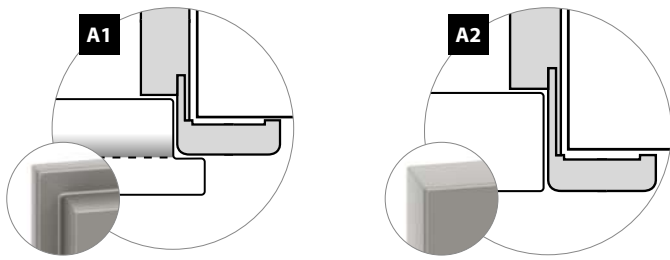

The edge of a **rebated door** leaf is finished with a rebate (visible in the picture A1) that overlaps a door frame when the door is closed. Door leaves made this way do not fit flush with a door frame.

The edge of a **non-rebated** door leaf has a flat surface. Door leaves made this way fit flush with a door frame (A2).

LEFT AND RIGHT DOOR

Before buying doors, it is worth considering in which direction they should open. For safety reasons, bathroom or kitchen doors should be installed in a way that makes it possible to open them outwards. In other areas, it is dependent on users' preference and the layout of the apartment or house.

The next step is to determine what kind of doors we are looking for; right or left doors. What does that mean? If the hinges are installed on the right side of a door frame, it means we need a right door, if the opposite—we have to choose the left door. Therefore, before going to the store it is worth reconsidering this question and writing down a list of needed right and left doors and to determine the opening direction for each of them.

LEFT DOOR

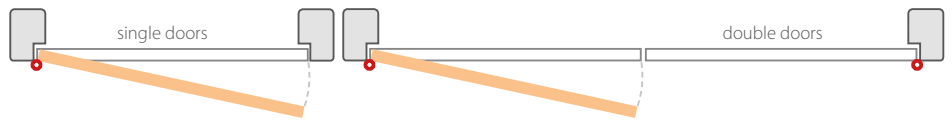

RIGHT DOOR



DOOR PRICE CALCULATION

In most cases, the quoted prices are for a door leaf without a door frame and door handles. To obtain the full price of the door set, you have to use the following calculation:



LEGEND

Please note the annotations marked with the following icons. They contain important information related to the door leaf models.

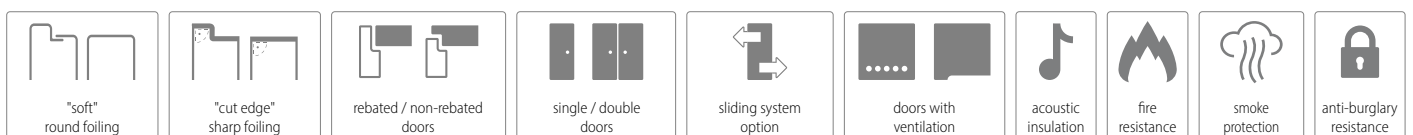

FOIL-TYPES OF WOOD TEXTURE (GRAINING)

Structures of INVADO foils can be divided into 3 categories:

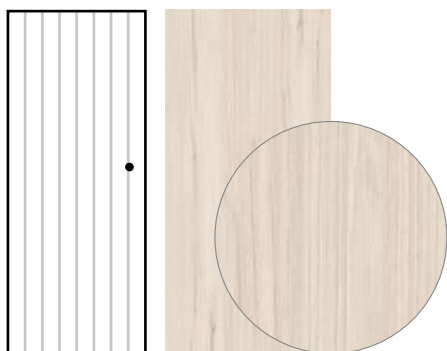

UNIDIRECTIONAL FOIL WITH VERTICAL TEXTURE:

Most INVADO foils are available in this type of texture. Exceptions: **Chestnut** (ENDURO), **Italian oak**, and **Severo oak** (ENDURO 3D).

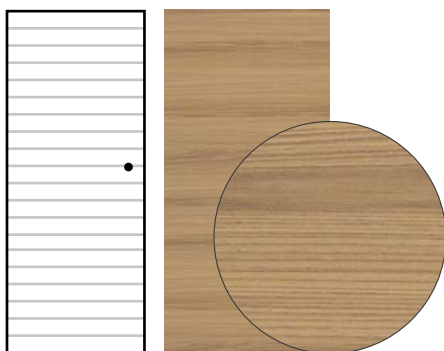

UNIDIRECTIONAL FOIL WITH HORIZONTAL TEXTURE:

Currently, there are two foils with this texture in the INVADO offer. These are: **Italian oak** and **Severo oak** (ENDURO 3D).

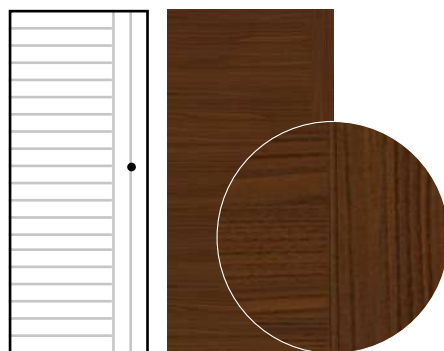

BIDIRECTIONAL FOIL WITH VERTICAL AND HORIZONTAL TEXTURE:

The combination of two previous types of texture. There is one foil of that type in the INVADO offer—**Chestnut** (ENDURO).



www.invado.pl

DOOR EDGE COLOUR

OPTIMO

duo line

Due to the manufacturing technique, for doors from the OPTIMO LINE collection, it is possible to use the edge of the leaf in a different colour than its surface. The base for creating unique creations is the edge in the colour: pure black, alpine white, or natural Hamilton oak in combination with the OPTIMO LINE colour palette (p. 13)

DOOR EDGE COLOUR	DOOR COLOUR
B726 pure black	COLOUR PALETTE FOR OPTIMO LINE (p. 13)
B688 alpine white	COLOUR PALETTE FOR OPTIMO LINE (p. 13)
B717 natural hamilton oak	B687, B688 alpine white (p. 13)

satinato



chinchilla



transparent



ENDURO

intensity of use: ●●○○○

ENDURO classification: Foil of high-quality design and a very good imitation of a natural wood structure. High durability.

Intended for: buildings and living quarters with a wide range of use.



ENDURO 3D

intensity of use: ●●○○○

Three-dimensional reproduction of the wood structure and high durability.

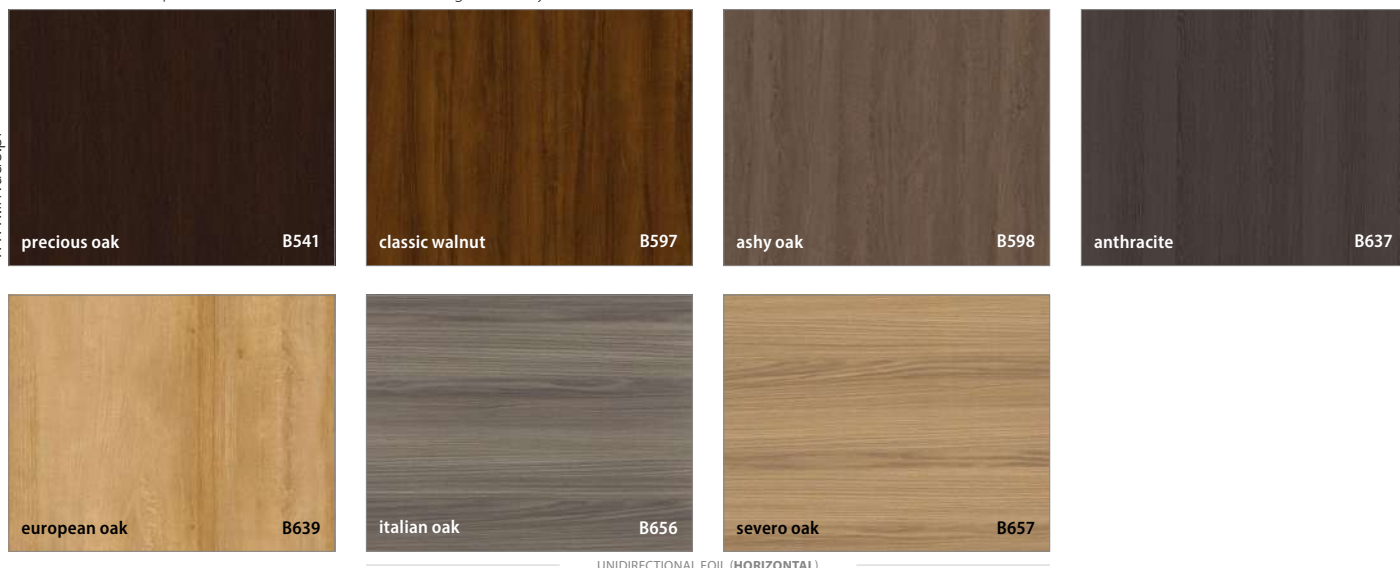

ENDURO PLUS

intensity of use: ●●○○○

Extended group of decors with high value, tactile structure and very high durability.

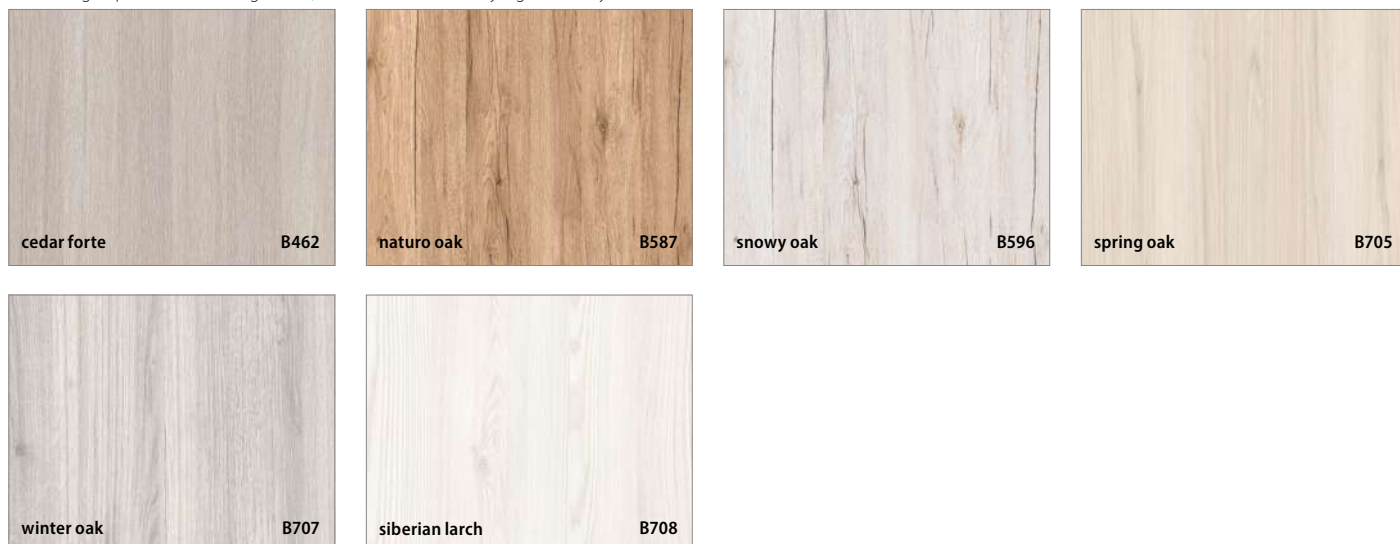

ECO-VENEER FORTE

intensity of use: ●●●○ **ECO-VENEER laminate CPL** ●●●○

ECO-VENEER FORTE classification — high-quality laminate in modern colours, very high durability. **CPL** — foil in modern colours.
Intended for: hotels, offices, public buildings.



LAMINATE CPL 0.15 mm / 0.8 mm

intensity of use: 0.15 mm: ●●●●○ 0.8 mm: ●●●●●

Maximum strength decors, dedicated exclusively to the OPTIMO LINE door collection. Available in 2 thicknesses: 0.15mm (door leaves and frames), 0.8mm (door leaves).

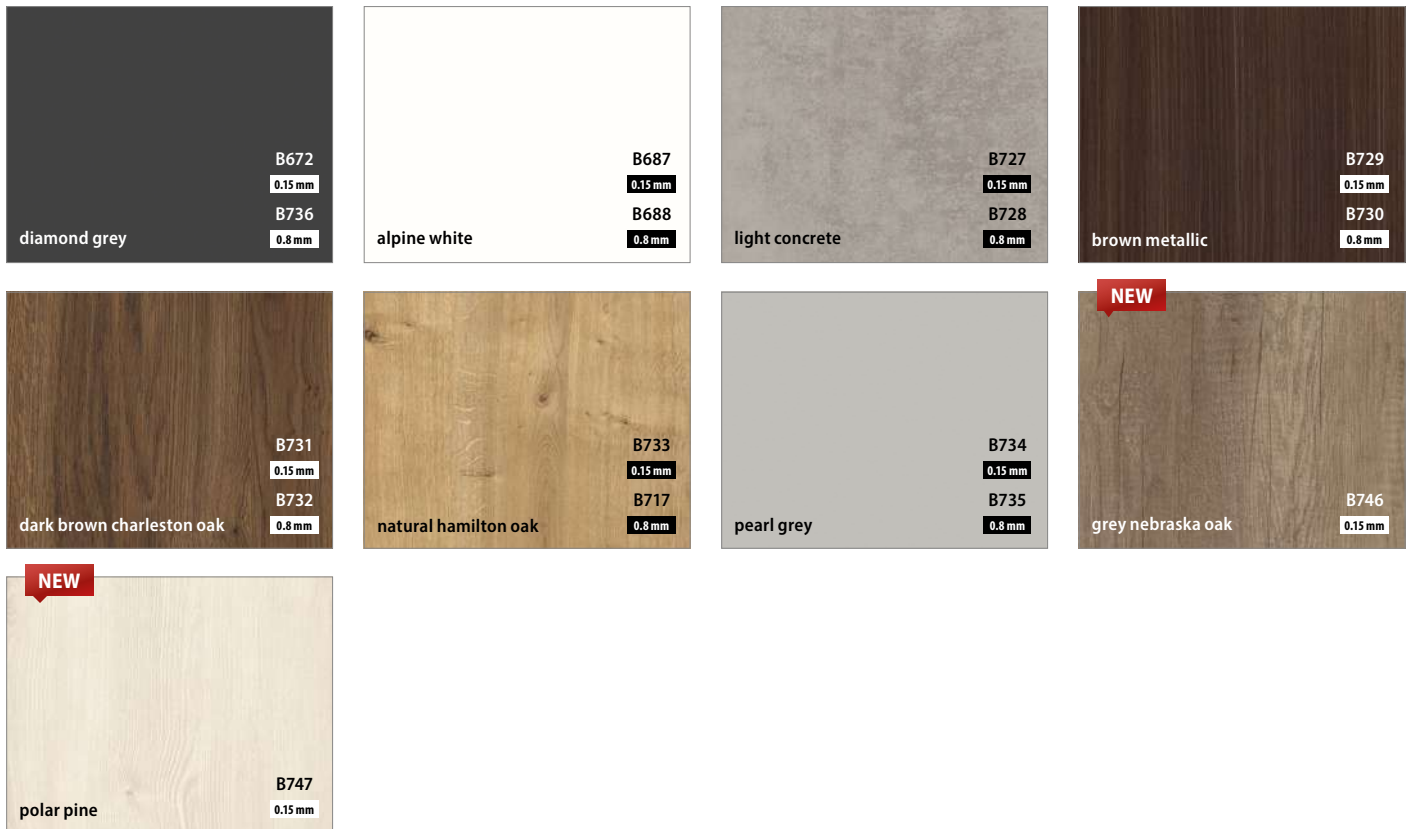

LAMINOLACK

intensity of use: ●●●●○ **LAMINOLACK** —

Classification LAMINOLACK: high-quality polypropylene foil is characterised by excellent durability.
Intended for: buildings and living quarters with a wide range of use.

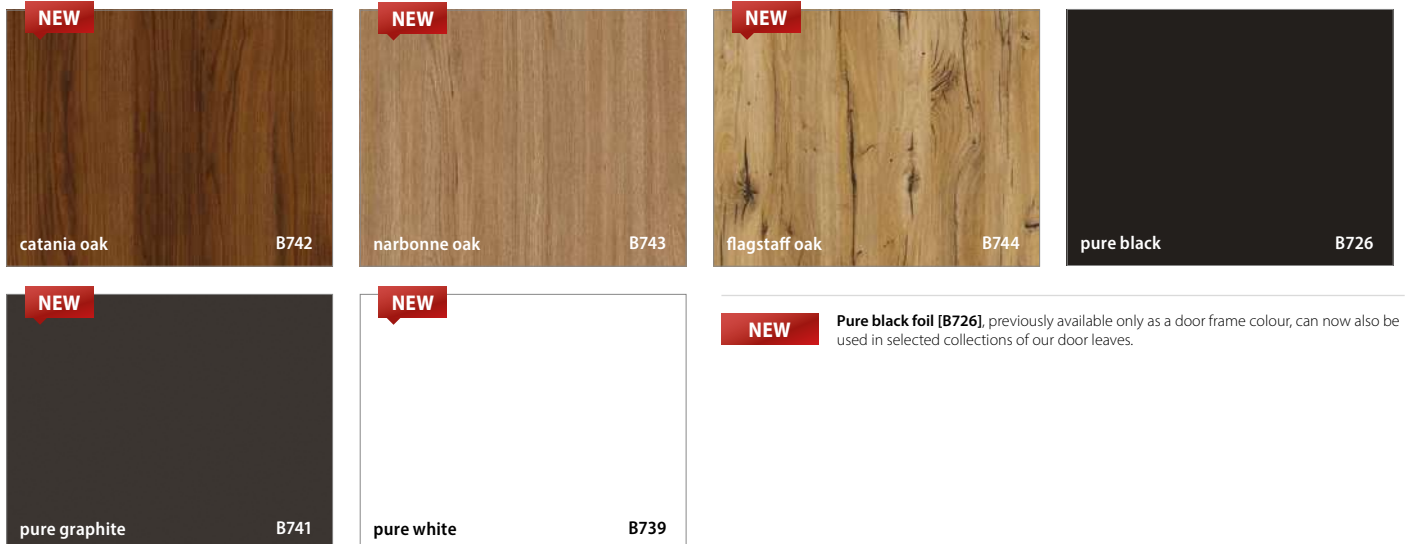

NEW Pure black foil [B726], previously available only as a door frame colour, can now also be used in selected collections of our door leaves.

CPL 0.15 mm and CPL 0.8 mm decors in NCS colours available for individual requests.

NCS S0907-Y30R Cotton Beige	NCS S1060-Y10R Brilliant Yellow	NCS S0560-G90Y Citrus Yellow	NCS S1505-Y50R Sand Beige	NCS S2060-Y10R Curry Yellow
NCS S3502-Y Pebble Grey	NCS S0502-Y50R Came Beige	NCS S5040-R Burgundy Red	NCS S1580-Y90R China Red	NCS S3060-R Chilli Red
NCS S7010-R30B Aubergine Purple	NCS S1030-R80B Horizon Blue	NCS S3060-R90B Delft Blue	NCS S8505-R80B Indigo Blue	NCS S3050-G40Y Kiwi Green
NCS S1060-G40Y Lime Green	NCS S5030-B30G Niagara Green	NCS S2005-Y60R Cashmere Grey	NCS S1500-N Silk Grey	NCS S2000-N Light Grey
NCS S4005-Y50R Stone Grey	NCS S5000-N Dust Grey	NCS S7005-Y20R Lava Grey	NCS S2005-Y20R Taupe Grey	NCS S6005-Y20R Cubanit Grey
NCS S1000-N White Grey	NCS S4500-N Arctic Grey	NCS S8500-N Solid Soft Black	NCS S6500-N Onyx Grey	NCS S8000-N Graphite Grey
NCS S9000-N Black	NCS S0502-G50Y Cream White	NCS S0300-N Platinum White	NCS S0500-N Premium White ST22	NCS S0500-N Premium White Solid

Details on a non-standard offer should be arranged
with the appropriate market manager
— see page 140.

CPL 0.15 mm and CPL 0.8 mm decors available for individual requests.

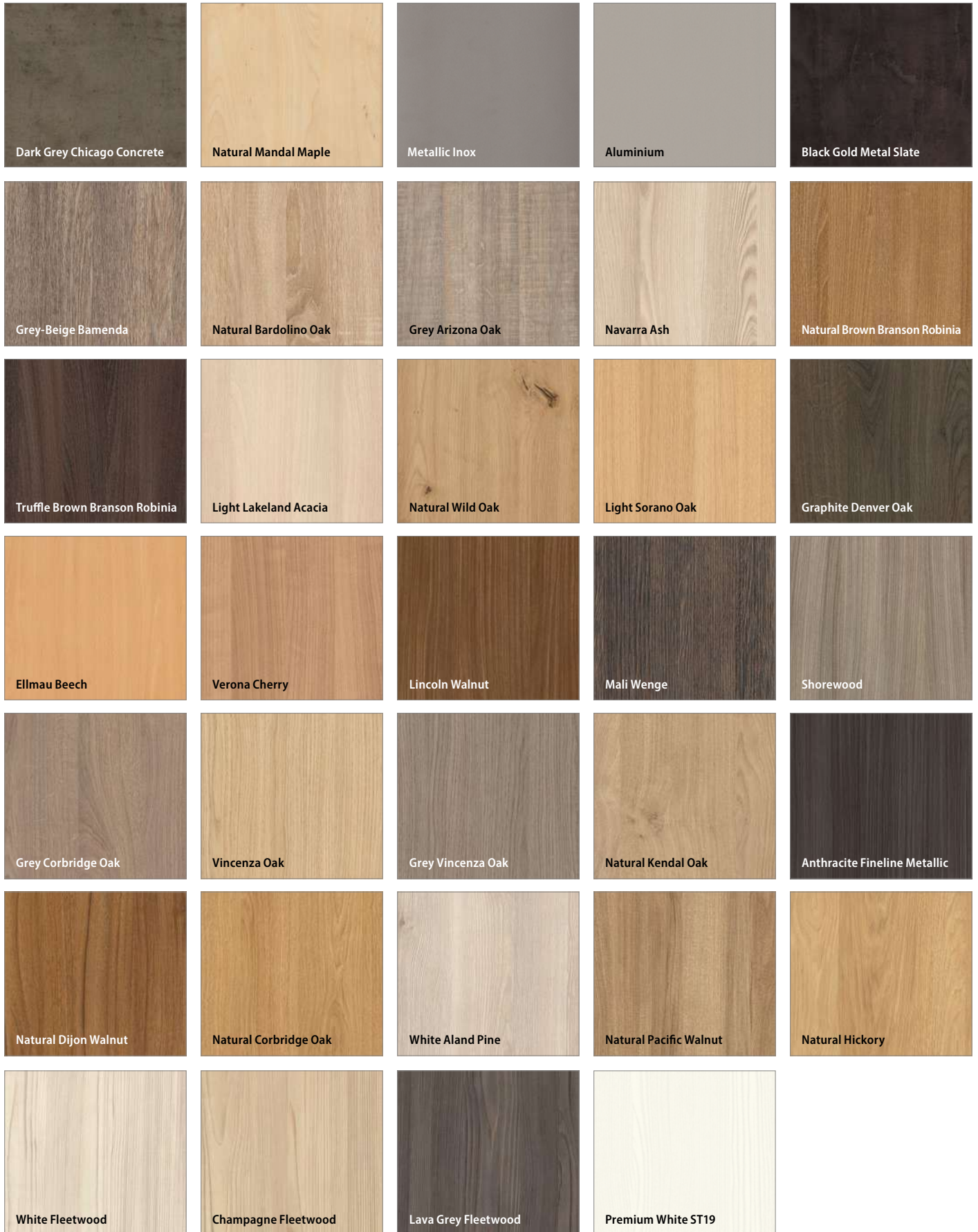

Details on a non-standard offer should be arranged
with the appropriate market manager
— see page 140.

COLLECTION OF

MODULAR DOORS

Corato	_____	18
Artano	_____	20
Aversa	_____	20
Mirror	_____	22
Lago	_____	24
Pasaro	_____	26
Vinadio	_____	28
Fossano	_____	30
Imperia	_____	32
Destino Unico	_____	34
Livata	_____	36
Versano	_____	38
Nogaro	_____	40
Tamparo	_____	42
Linea Forte	_____	44
Capena Inserto	_____	46
Martina	_____	48
Domino	_____	50
Bianco	_____	52
Larina	_____	54
D'Artagnan	_____	56





Non-rebated Corato 5 in B476
Door frame in B490



www.in.vado.pl



WATCH THE ASSEMBLY VIDEOS ON OUR YOUTUBE CHANNEL

DOOR LEAVES OPTIONS

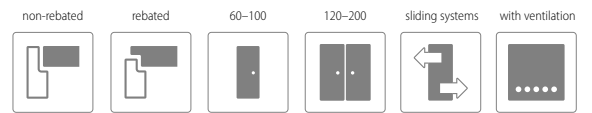

DECORS

ENDURO **

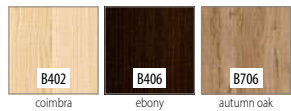

ENDURO 3D **



LAMINOLACK **** NEW



ENDURO PLUS **



ECO-VENEER FORTE ***



ECO-VENEER CPL ***





CONSTRUCTION

- 1** filling element: 22 mm thick panel
- 2** filling element: panel or glass depending on the model (4 mm thick). Model 6 has black panels in B726
- 3** the frame is made of an MDF board: upper part of the frame is 350 mm high, lower part of the frame is 400 mm high
- 4** door leaf covered with ENDURO foil, ECO-VENEER or LAMINOLACK
 - side edges and upper edge are foiled
 - rounded vertical edges of door leaves (more info on p. 122)
 - double door leaves have a rebate and a counter-rebate (drawing on p. 122)
 - width of single doors: "60"–"100" / width of double doors: "120"–"200"

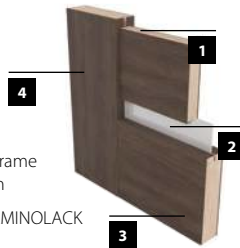

STANDARD EQUIPMENT

- | | |
|-------------|--|
| rebated | <ul style="list-style-type: none"> • lock 72 mm for a standard key, a WC knob, or a cylinder lock insert • screw-in pivot hinges 13.5/9 (white zinc)—2 pcs for door leaves in sizes "60"–"80", 3 pcs for door leaves in sizes "90" and "100" |
| non-rebated | <ul style="list-style-type: none"> • magnetic lock 90 mm for a standard key, 95 mm for a WC knob, and 85 mm for a cylinder lock insert • hidden hinges with a 3D regulation in the colour satin chrome |

DEDICATED DOOR FRAMES

- | | |
|---|------------|
| • [OB3] block door frame (possibility to add an architrave 10 x 60 mm or 16 x 80 mm) | P. 125 |
| • [ORS1] adjustable door frame for rebated doors with a flat angle architrave 60 mm-wide | P. 126 |
| • [ORS8] adjustable door frame for rebated doors with a flat angle architrave 80 mm-wide | P. 126 |
| • [ORS7] adjustable door frame for modular non-rebated doors with a flat angle architrave 60 mm-wide | P. 127 |
| • [ORS10] adjustable door frame for modular non-rebated doors with a flat angle architrave 80 mm-wide | P. 127 |
| • [ORS4] adjustable 90° door frame for modular non-rebated doors with a flat angle architrave 80 mm-wide | P. 127 |
| • NOTE: THE OFFER ALSO INCLUDES METAL DOOR FRAMES | P. 128-129 |

ADDITIONAL OPTIONS

- door without a keyhole no extra charge
- door width "100"
- additional hinge for the door in sizes "60"–"80"
- additional hinge for the non-rebated door—included in a door frame
- caps for hinges (chrome, satin chrome, golden, black)—set for 1 hinge unit
- ventilation undercut
- PVC ventilation sleeves
- metal ventilation sleeves, round (chrome, golden)
- metal ventilation sleeves, square (chrome, nickel)
- door made in a non-rebated version for sliding systems
- door made in non-rebated version
- double door
- cylinder lock insert 31/36 (31/31 in non-rebated door leaves)
- automatic bottom door seal, widths "60"–"100"
- aluminium threshold, widths "60"–"100"

Additional information: equipment and accessories

P. 133–137

GLASS

the glossy side of glass is on the hinge side



Rebated Artano 2 in B462



WATCH THE ASSEMBLY VIDEOS ON OUR YOUTUBE CHANNEL

DOOR LEAVES OPTIONS

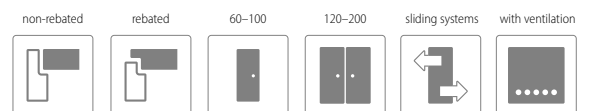

DECORS

ENDURO **



ENDURO 3D **



LAMINOLACK **** NEW



ENDURO PLUS **



ECO-VENEER FORTE ***



ECO-VENEER CPL ***





CONSTRUCTION

- 1** filling element: 16 mm thick panel
- 2** filling element: panel or glass depending on the model (4 mm thick). Aversa 3 has a black panel in B726
- 3** the frame is made of an MDF board
- 4** door leaf covered with ENDURO foil, ECO-VENEER or LAMINOLACK
 - side edges and upper edge are foiled
 - rounded vertical edges of door leaves (more info on p. 122)
 - double door leaves have a rebate and a counter-rebate (drawing on p. 122)
 - width of single doors: "60"- "100" / width of double doors: "120"- "200"



ADDITIONAL OPTIONS

- door without a keyhole no extra charge
- door width "100"
- additional hinge for the door in sizes "60"- "80"
- additional hinge for the non-rebated door—included in a door frame
- caps for hinges (chrome, satin chrome, golden, black)—set for 1 hinge unit
- ventilation undercut
- PVC ventilation sleeves
- metal ventilation sleeves, round (chrome, golden)
- metal ventilation sleeves, square (chrome, nickel)
- door made in a non-rebated version for sliding systems
- door made in non-rebated version
- double door
- cylinder lock insert 31/36 (31/31 in non-rebated door leaves)
- automatic bottom door seal, widths "60"- "100"
- aluminium threshold, widths "60"- "100"

Additional information: equipment and accessories

P. 133-137

STANDARD EQUIPMENT

- | | |
|-------------|---|
| rebated | <ul style="list-style-type: none"> • lock 72 mm for a standard key, a WC knob, or a cylinder lock insert • screw-in pivot hinges 13.5/9 (white zinc)—2 pcs for door leaves in sizes "60"- "80", 3 pcs for door leaves in sizes "90" and "100" |
| non-rebated | <ul style="list-style-type: none"> • magnetic lock 90 mm for a standard key, 95 mm for a WC knob, and 85 mm for a cylinder lock insert • hidden hinges with a 3D regulation in the colour satin chrome |

DEDICATED DOOR FRAMES

- **[OB3]** block door frame (possibility to add an architrave 10 x 60 mm or 16 x 80 mm) P. 125
- **[ORS1]** adjustable door frame for rebated doors with a flat angle architrave 60 mm-wide P. 126
- **[ORS8]** adjustable door frame for rebated doors with a flat angle architrave 80 mm-wide P. 126
- **[ORS7]** adjustable door frame for modular non-rebated doors with a flat angle architrave 60 mm-wide P. 127
- **[ORS10]** adjustable door frame for modular non-rebated doors with a flat angle architrave 80 mm-wide P. 127
- **[ORS4]** adjustable 90° door frame for modular non-rebated doors with a flat angle architrave 80 mm-wide P. 127
- NOTE: THE OFFER ALSO INCLUDES METAL DOOR FRAMES P. 128-129

GLASS

the glossy side of glass is on the hinge side



Non-rebated Mirror 2 in B490



www.invado.pl



WATCH THE ASSEMBLY VIDEOS ON OUR YOUTUBE CHANNEL

DOOR LEAVES OPTIONS

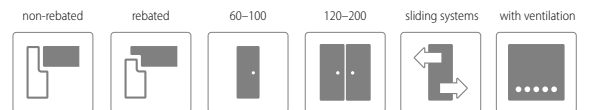

DECORS

ENDURO **

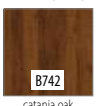
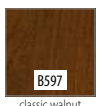

ENDURO 3D **

LAMINOLACK **** NEW

ENDURO PLUS **



ECO-VENEER FORTE ***



ECO-VENEER CPL ***





Mirror 1—mirror on the door frame side



Mirror 1—panel on the hinge side



Mirror 2—panel on the door frame side



Mirror 2—mirror on the hinge side

CONSTRUCTION

- 1** filling element: 6 mm thick panel
- 2** filling element: mirror (4 mm thick)
- 3** the frame is made of an MDF board
- 4** door leaf covered with ENDURO foil, ECO-VENEER or LAMINOLACK
 - side edges and upper edge are foiled
 - rounded vertical edges of door leaves (more info on p. 122)
 - double door leaves have a rebate and a counter-rebate (drawing on p. 122)
 - width of single doors: "60"—"100" / width of double doors: "120"—"200"

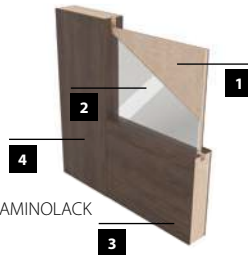

STANDARD EQUIPMENT

- | | |
|-------------|--|
| rebated | <ul style="list-style-type: none"> • lock 72 mm for a standard key, a WC knob, or a cylinder lock insert • screw-in pivot hinges 13.5/9 (white zinc)—2 pcs for door leaves in sizes "60"—"80", 3 pcs for door leaves in sizes "90" and "100" |
| non-rebated | <ul style="list-style-type: none"> • magnetic lock 90 mm for a standard key, 95 mm for a WC knob, and 85 mm for a cylinder lock insert • hidden hinges with a 3D regulation in the colour satin chrome |

DEDICATED DOOR FRAMES

- **[OB3]** block door frame (possibility to add an architrave 10 x 60 mm or 16 x 80 mm) **P. 125**
- **[ORS1]** adjustable door frame for rebated doors with a flat angle architrave 60 mm-wide **P. 126**
- **[ORS8]** adjustable door frame for rebated doors with a flat angle architrave 80 mm-wide **P. 126**
- **[ORS7]** adjustable door frame for modular non-rebated doors with a flat angle architrave 60 mm-wide **P. 127**
- **[ORS10]** adjustable door frame for modular non-rebated doors with a flat angle architrave 80 mm-wide **P. 127**
- **[ORS4]** adjustable 90° door frame for modular non-rebated doors with a flat angle architrave 80 mm-wide **P. 127**
- NOTE: THE OFFER ALSO INCLUDES METAL DOOR FRAMES **P. 128-129**

ADDITIONAL OPTIONS

- door without a keyhole no extra charge
- door width "100"
- additional hinge for the door in sizes "60"—"80"
- additional hinge for the non-rebated door—included in a door frame
- caps for hinges (chrome, satin chrome, golden, black)—set for 1 hinge unit
- ventilation undercut
- PVC ventilation sleeves
- metal ventilation sleeves, round (chrome, golden)
- metal ventilation sleeves, square (chrome, nickel)
- door made in a non-rebated version for sliding systems
- door made in non-rebated version
- double door
- cylinder lock insert 31/36 (31/31 in non-rebated door leaves)
- automatic bottom door seal, widths "60"—"100"
- aluminium threshold, widths "60"—"100"

Additional information: equipment and accessories

P. 133-137

Rebated Lago 4 in B707



www.invadopl



WATCH THE ASSEMBLY VIDEOS ON OUR YOUTUBE CHANNEL

DOOR LEAVES OPTIONS

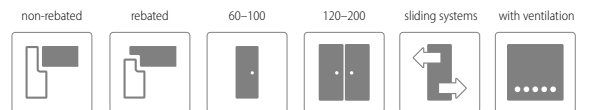

DECORS

ENDURO **



ENDURO 3D **



LAMINOLACK ****



ENDURO PLUS **



ECO-VENEER FORTE ***



ECO-VENEER CPL ***





CONSTRUCTION

- 1** filling element: 22 mm thick panel
- 2** filling element: panel or glass, depending on the model (4 mm thick)
- 3** the frame is made of an MDF board
- 4** door leaf covered with ENDURO foil or ECO-VENEER
 - side edges and upper edge are foiled
 - rounded vertical edges of door leaves (more info on p. 122)
 - double door leaves have a rebate and a counter-rebate (drawing on p. 122)
 - width of single doors: "60"–"100" / width of double doors: "120"–"200"

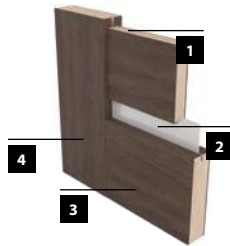

ADDITIONAL OPTIONS

- door without a keyhole no extra charge
- door width "100"
- additional hinge for the door in sizes "60"–"80"
- additional hinge for the non-rebated door—included in a door frame
- caps for hinges (chrome, satin chrome, golden, black)—set for 1 hinge unit
- ventilation undercut
- PVC ventilation sleeves
- metal ventilation sleeves, round (chrome, golden)
- metal ventilation sleeves, square (chrome, nickel)
- door made in a non-rebated version for sliding systems
- door made in non-rebated version
- double door
- cylinder lock insert 31/36 (31/31 in non-rebated door leaves)
- automatic bottom door seal, widths "60"–"100"
- aluminium threshold, widths "60"–"100"

Additional information: equipment and accessories

P. 133–137

STANDARD EQUIPMENT

- | | |
|-------------|--|
| rebated | <ul style="list-style-type: none"> • lock 72 mm for a standard key, a WC knob, or a cylinder lock insert • screw-in pivot hinges 13.5/9 (white zinc)—2 pcs for door leaves in sizes "60"–"80", 3 pcs for door leaves in sizes "90" and "100" |
| non-rebated | <ul style="list-style-type: none"> • magnetic lock 90 mm for a standard key, 95 mm for a WC knob, and 85 mm for a cylinder lock insert • hidden hinges with a 3D regulation in the colour satin chrome |

DEDICATED DOOR FRAMES

- **[OB3]** block door frame (possibility to add an architrave 10 x 60 mm or 16 x 80 mm) P. 125
- **[ORS1]** adjustable door frame for rebated doors with a flat angle architrave 60 mm-wide P. 126
- **[ORS8]** adjustable door frame for rebated doors with a flat angle architrave 80 mm-wide P. 126
- **[ORS7]** adjustable door frame for modular non-rebated doors with a flat angle architrave 60 mm-wide P. 127
- **[ORS10]** adjustable door frame for modular non-rebated doors with a flat angle architrave 80 mm-wide P. 127
- **[ORS4]** adjustable 90° door frame for modular non-rebated doors with a flat angle architrave 80 mm-wide P. 127
- NOTE: THE OFFER ALSO INCLUDES METAL DOOR FRAMES P. 128–129

GLASS

the glossy side of glass is on the hinge side



Rebated Pasaro 4 in B706



WATCH THE ASSEMBLY VIDEOS ON OUR YOUTUBE CHANNEL

DOOR LEAVES OPTIONS

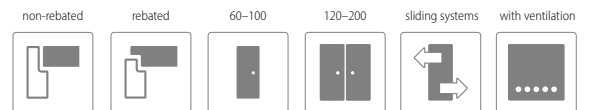

DECORS

ENDURO **



ENDURO 3D **



LAMINOLACK ****

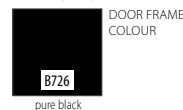

ENDURO PLUS **



ECO-VENEER FORTE ***



ECO-VENEER CPL ***





CONSTRUCTION

- 1** filling element: 22 mm thick panel
- 2** filling element: panel or glass, depending on the model (4 mm thick)
- 3** the frame is made of an MDF board: upper part of the frame is 350 mm high, lower part of the frame is 400 mm high
- 4** door leaf covered with ENDURO foil or ECO-VENEER
 - side edges and upper edge are foiled
 - rounded vertical edges of door leaves (more info on p. 122)
 - double door leaves have a rebate and a counter-rebate (drawing on p. 122)
 - width of single doors: "60"–"100" / width of double doors: "120"–"200"

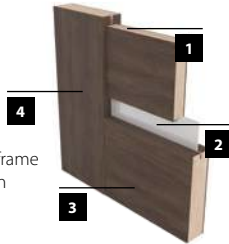

STANDARD EQUIPMENT

- | | |
|-------------|--|
| rebated | <ul style="list-style-type: none"> • lock 72 mm for a standard key, a WC knob, or a cylinder lock insert • screw-in pivot hinges 13.5/9 (white zinc)—2 pcs for door leaves in sizes "60"–"80", 3 pcs for door leaves in sizes "90" and "100" |
| non-rebated | <ul style="list-style-type: none"> • magnetic lock 90 mm for a standard key, 95 mm for a WC knob, and 85 mm for a cylinder lock insert • hidden hinges with a 3D regulation in the colour satin chrome |

DEDICATED DOOR FRAMES

- | | |
|---|------------|
| • [OB3] block door frame (possibility to add an architrave 10 x 60 mm or 16 x 80 mm) | P. 125 |
| • [ORS1] adjustable door frame for rebated doors with a flat angle architrave 60 mm-wide | P. 126 |
| • [ORS8] adjustable door frame for rebated doors with a flat angle architrave 80 mm-wide | P. 126 |
| • [ORS7] adjustable door frame for modular non-rebated doors with a flat angle architrave 60 mm-wide | P. 127 |
| • [ORS10] adjustable door frame for modular non-rebated doors with a flat angle architrave 80 mm-wide | P. 127 |
| • [ORS4] adjustable 90° door frame for modular non-rebated doors with a flat angle architrave 80 mm-wide | P. 127 |
| • NOTE: THE OFFER ALSO INCLUDES METAL DOOR FRAMES | P. 128-129 |

ADDITIONAL OPTIONS

- door without a keyhole no extra charge
- door width "100"
- additional hinge for the door in sizes "60"–"80"
- additional hinge for the non-rebated door—included in a door frame
- caps for hinges (chrome, satin chrome, golden, black)—set for 1 hinge unit
- ventilation undercut
- PVC ventilation sleeves
- metal ventilation sleeves, round (chrome, golden)
- metal ventilation sleeves, square (chrome, nickel)
- door made in a non-rebated version for sliding systems
- door made in non-rebated version
- double door
- cylinder lock insert 31/36 (31/31 in non-rebated door leaves)
- automatic bottom door seal, widths "60"–"100"
- aluminium threshold, widths "60"–"100"

Additional information: equipment and accessories

P. 133–137

GLASS

the glossy side of glass is on the hinge side



Rebated Vinadio 2 in B490



www.invado.pl



WATCH THE ASSEMBLY VIDEOS ON OUR YOUTUBE CHANNEL

DOOR LEAVES OPTIONS

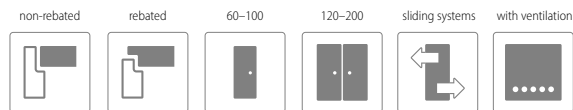

DECORS

ENDURO **



ENDURO 3D **



LAMINOLACK ****



ENDURO PLUS **



ECO-VENEER FORTE ***



ECO-VENEER CPL ***



Vinaccio 1



Vinaccio 2



Vinaccio 3



CONSTRUCTION

- 1** filling element: 22 mm thick panel
- 2** filling element: panel or glass, depending on the model (4 mm thick)
- 3** the frame is made of an MDF board
- 4** door leaf covered with ENDURO foil or ECO-VENEER
 - side edges and upper edge are foiled
 - rounded vertical edges of door leaves (more info on p. 122)
 - double door leaves have a rebate and a counter-rebate (drawing on p. 122)
 - width of single doors: "60"–"100" / width of double doors: "120"–"200"



STANDARD EQUIPMENT

- | | |
|-------------|--|
| rebated | <ul style="list-style-type: none"> • lock 72 mm for a standard key, a WC knob, or a cylinder lock insert • screw-in pivot hinges 13.5/9 (white zinc)—2 pcs for door leaves in sizes "60"–"80", 3 pcs for door leaves in sizes "90" and "100" |
| non-rebated | <ul style="list-style-type: none"> • magnetic lock 90 mm for a standard key, 95 mm for a WC knob, and 85 mm for a cylinder lock insert • hidden hinges with a 3D regulation in the colour satin chrome |

DEDICATED DOOR FRAMES

- **[OB3]** block door frame (possibility to add an architrave 10 x 60 mm or 16 x 80 mm) **P. 125**
- **[ORS1]** adjustable door frame for rebated doors with a flat angle architrave 60 mm-wide **P. 126**
- **[ORS8]** adjustable door frame for rebated doors with a flat angle architrave 80 mm-wide **P. 126**
- **[ORS7]** adjustable door frame for modular non-rebated doors with a flat angle architrave 60 mm-wide **P. 127**
- **[ORS10]** adjustable door frame for modular non-rebated doors with a flat angle architrave 80 mm-wide **P. 127**
- **[ORS4]** adjustable 90° door frame for modular non-rebated doors with a flat angle architrave 80 mm-wide **P. 127**
- NOTE: THE OFFER ALSO INCLUDES METAL DOOR FRAMES **P. 128-129**

ADDITIONAL OPTIONS

- door without a keyhole no extra charge
- door width "100"
- additional hinge for the door in sizes "60"–"80"
- additional hinge for the non-rebated door—included in a door frame
- caps for hinges (chrome, satin chrome, golden, black)—set for 1 hinge unit
- ventilation undercut
- PVC ventilation sleeves
- metal ventilation sleeves, round (chrome, golden)
- metal ventilation sleeves, square (chrome, nickel)
- door made in a non-rebated version for sliding systems
- door made in non-rebated version
- double door
- cylinder lock insert 31/36 (31/31 in non-rebated door leaves)
- automatic bottom door seal, widths "60"–"100"
- aluminium threshold, widths "60"–"100"

Additional information: equipment and accessories

P. 133–137

GLASS

the glossy side of glass is on the hinge side





DOOR LEAVES OPTIONS

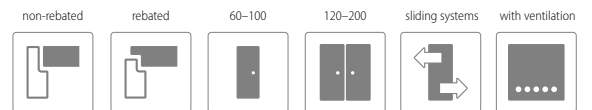

DECORS

ENDURO **



ENDURO 3D **



ENDURO PLUS **

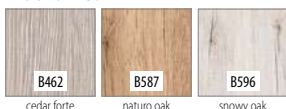

ECO-VENEER FORTE ***

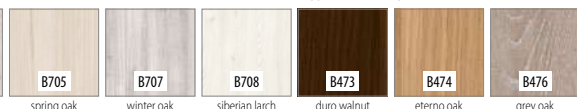

LAMINOLACK ****



ECO-VENEER CPL ***





CONSTRUCTION

- 1** filling element: 22 mm thick panel
- 2** filling element: panel or glass, depending on the model (4 mm thick)
- 3** the frame is made of an MDF board
- 4** door leaf covered with ENDURO foil or ECO-VENEER
 - side edges and upper edge are foiled
 - rounded vertical edges of door leaves (more info on p. 122)
 - double door leaves have a rebate and a counter-rebate (drawing on p. 122)
 - width of single doors: "60"-"100" / width of double doors: "120"-"200"



STANDARD EQUIPMENT

- | | |
|-------------|--|
| rebated | <ul style="list-style-type: none"> • lock 72 mm for a standard key, a WC knob, or a cylinder lock insert • screw-in pivot hinges 13.5/9 (white zinc)—2 pcs for door leaves in sizes "60"-"80", 3 pcs for door leaves in sizes "90" and "100" |
| non-rebated | <ul style="list-style-type: none"> • magnetic lock 90 mm for a standard key, 95 mm for a WC knob, and 85 mm for a cylinder lock insert • hidden hinges with a 3D regulation in the colour satin chrome |

DEDICATED DOOR FRAMES

- **[OB3]** block door frame (possibility to add an architrave 10 x 60 mm or 16 x 80 mm) **P. 125**
- **[ORS1]** adjustable door frame for rebated doors with a flat angle architrave 60 mm-wide **P. 126**
- **[ORS8]** adjustable door frame for rebated doors with a flat angle architrave 80 mm-wide **P. 126**
- **[ORS7]** adjustable door frame for modular non-rebated doors with a flat angle architrave 60 mm-wide **P. 127**
- **[ORS10]** adjustable door frame for modular non-rebated doors with a flat angle architrave 80 mm-wide **P. 127**
- **[ORS4]** adjustable 90° door frame for modular non-rebated doors with a flat angle architrave 80 mm-wide **P. 127**
- NOTE: THE OFFER ALSO INCLUDES METAL DOOR FRAMES **P. 128-129**

ADDITIONAL OPTIONS

- door without a keyhole no extra charge
- door width "100"
- additional hinge for the door in sizes "60"-"80"
- additional hinge for the non-rebated door—included in a door frame
- caps for hinges (chrome, satin chrome, golden, black)—set for 1 hinge unit
- ventilation undercut
- PVC ventilation sleeves
- metal ventilation sleeves, round (chrome, golden)
- metal ventilation sleeves, square (chrome, nickel)
- door made in a non-rebated version for sliding systems
- door made in non-rebated version
- double door
- cylinder lock insert 31/36 (31/31 in non-rebated door leaves)
- automatic bottom door seal, widths "60"-"100"
- aluminium threshold, widths "60"-"100"

Additional information: equipment and accessories

P. 133-137

GLASS

the glossy side of glass is on the hinge side



Rebated Imperia 2 in B598



WATCH THE ASSEMBLY VIDEOS ON OUR YOUTUBE CHANNEL

DOOR LEAVES OPTIONS

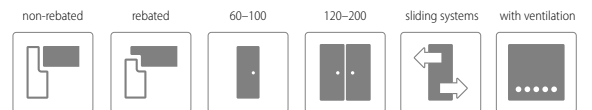

DECORS

ENDURO **

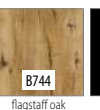
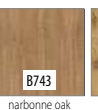
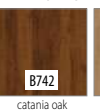
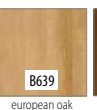
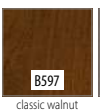

ENDURO 3D **

LAMINOLACK **** NEW

ENDURO PLUS **

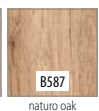

ECO-VENEER FORTE ***

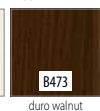

ECO-VENEER CPL ***





CONSTRUCTION

- 1** filling element: 22 mm thick panel
- 2** filling element: panel or glass, depending on the model (4 mm thick)
- 3** the frame is made of an MDF board: upper part of the frame is 350 mm high, lower part of the frame is 400 mm high
- 4** door leaf covered with ENDURO foil, ECO-VENEER or LAMINOLACK
 - side edges and upper edge are foiled
 - rounded vertical edges of door leaves (more info on p. 122)
 - double door leaves have a rebate and a counter-rebate (drawing on p. 122)
 - width of single doors: "60"-"100" / width of double doors: "120"-"200"

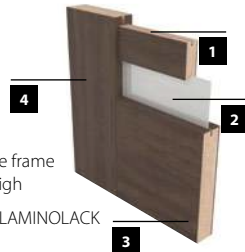

ADDITIONAL OPTIONS

- door without a keyhole no extra charge
- door width "100"
- additional hinge for the door in sizes "60"-"80"
- additional hinge for the non-rebated door—included in a door frame
- caps for hinges (chrome, satin chrome, golden, black)—set for 1 hinge unit
- ventilation undercut
- PVC ventilation sleeves
- metal ventilation sleeves, round (chrome, golden)
- metal ventilation sleeves, square (chrome, nickel)
- door made in a non-rebated version for sliding systems
- door made in non-rebated version
- double door
- cylinder lock insert 31/36 (31/31 in non-rebated door leaves)
- automatic bottom door seal, widths "60"-"100"
- aluminium threshold, widths "60"-"100"

Additional information: equipment and accessories

P. 133-137

STANDARD EQUIPMENT

- | | |
|-------------|--|
| rebated | <ul style="list-style-type: none"> • lock 72 mm for a standard key, a WC knob, or a cylinder lock insert • screw-in pivot hinges 13.5/9 (white zinc)—2 pcs for door leaves in sizes "60"-"80", 3 pcs for door leaves in sizes "90" and "100" |
| non-rebated | <ul style="list-style-type: none"> • magnetic lock 90 mm for a standard key, 95 mm for a WC knob, and 85 mm for a cylinder lock insert • hidden hinges with a 3D regulation in the colour satin chrome |

DEDICATED DOOR FRAMES

- **[OB3]** block door frame (possibility to add an architrave 10 x 60 mm or 16 x 80 mm) P. 125
- **[ORS1]** adjustable door frame for rebated doors with a flat angle architrave 60 mm-wide P. 126
- **[ORS8]** adjustable door frame for rebated doors with a flat angle architrave 80 mm-wide P. 126
- **[ORS7]** adjustable door frame for modular non-rebated doors with a flat angle architrave 60 mm-wide P. 127
- **[ORS10]** adjustable door frame for modular non-rebated doors with a flat angle architrave 80 mm-wide P. 127
- **[ORS4]** adjustable 90° door frame for modular non-rebated doors with a flat angle architrave 80 mm-wide P. 127
- NOTE: THE OFFER ALSO INCLUDES METAL DOOR FRAMES P. 128-129

GLASS

the glossy side of glass is on the hinge side





Rebated Destino Unico 5 in B587



WATCH THE ASSEMBLY VIDEOS ON OUR YOUTUBE CHANNEL

DOOR LEAVES OPTIONS

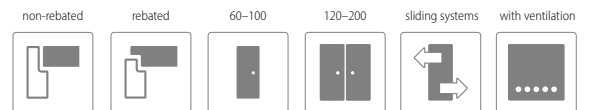

DECORS

ENDURO **



ENDURO 3D **



LAMINOLACK ****



ENDURO PLUS **



ECO-VENEER FORTE ***



ECO-VENEER CPL ***





One of the most popular models of INVADO doors—DESTINO UNICO—has been awarded a "Gold Medal". These door leaves make a bold combination of colours which allows the creation of intriguing, stylized interiors.

Therefore, we did not doubt that this was the most suitable collection to be submitted to the prestigious "Gold Medal" contest, held at the International Poznań Fair BUDMA. The IPF "Gold Medal" is one of the most recognizable awards in the Polish market, which is given to innovative products of the highest quality. We are proud of this achievement and we would like to thank all those involved in the production and sales of our Destino Unico doors.

CONSTRUCTION

- 1** filling element: panel or glass, depending on the model (4 mm thick)
- 2** filling element: 22 mm thick panel
- 3** the frame is made of an MDF board
- 4** double-sides glass insert—80 mm wide
- 5** door leaf covered with ENDURO foil or ECO-VENEER
 - side edges and upper edge are foiled
 - rounded vertical edges of door leaves (more info on p. 122)
 - double door leaves have a rebate and a counter-rebate (drawing on p. 122)
 - width of single doors: "60"—"100" / width of double doors: "120"—"200"



ADDITIONAL OPTIONS

- door without a keyhole no extra charge
- door width "100"
- additional hinge for the door in sizes "60"—"80"
- additional hinge for the non-rebated door—included in a door frame
- caps for hinges (chrome, satin chrome, golden, black)—set for 1 hinge unit
- ventilation undercut
- PVC ventilation sleeves
- metal ventilation sleeves, round (chrome, golden)
- metal ventilation sleeves, square (chrome, nickel)
- door made in a non-rebated version for sliding systems
- door made in non-rebated version
- double door
- cylinder lock insert 31/36 (31/31 in non-rebated door leaves)
- automatic bottom door seal, widths "60"—"100"
- aluminium threshold, widths "60"—"100"

Additional information: equipment and accessories P. 133-137

STANDARD EQUIPMENT

- | | |
|-------------|--|
| rebated | <ul style="list-style-type: none"> • lock 72 mm for a standard key, a WC knob, or a cylinder lock insert • screw-in pivot hinges 13.5/9 (white zinc)—2 pcs for door leaves in sizes "60"—"80", 3 pcs for door leaves in sizes "90" and "100" |
| non-rebated | <ul style="list-style-type: none"> • magnetic lock 90 mm for a standard key, 95 mm for a WC knob, and 85 mm for a cylinder lock insert • hidden hinges with a 3D regulation in the colour satin chrome |

DEDICATED DOOR FRAMES

- **[OB3]** block door frame (possibility to add an architrave 10 x 60 mm or 16 x 80 mm) P. 125
- **[ORS1]** adjustable door frame for rebated doors with a flat angle architrave 60 mm-wide P. 126
- **[ORS8]** adjustable door frame for rebated doors with a flat angle architrave 80 mm-wide P. 126
- **[ORS7]** adjustable door frame for modular non-rebated doors with a flat angle architrave 60 mm-wide P. 127
- **[ORS10]** adjustable door frame for modular non-rebated doors with a flat angle architrave 80 mm-wide P. 127
- **[ORS4]** adjustable 90° door frame for modular non-rebated doors with a flat angle architrave 80 mm-wide P. 127
- NOTE: THE OFFER ALSO INCLUDES METAL DOOR FRAMES P. 128-129

GLASS

the glossy side of glass is on the hinge side

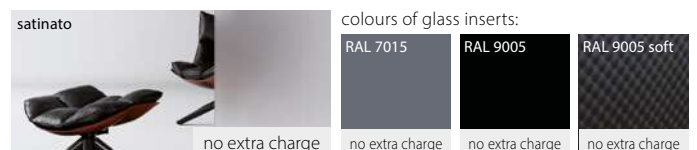

Non-rebated Livata 1 in B597



www.invado.pl



WATCH THE ASSEMBLY VIDEOS ON OUR YOUTUBE CHANNEL

DOOR LEAVES OPTIONS

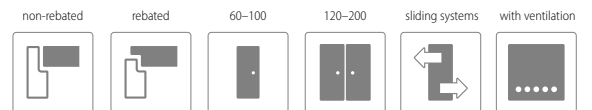

DECORS

ENDURO **



ENDURO 3D **



LAMINOLACK ****



ENDURO PLUS **



ECO-VENEER FORTE ***



ECO-VENEER CPL ***



Livata 1



Livata 2



Livata 3



Livata 4



CONSTRUCTION

- 1** filling element: 22 mm thick panel
- 2** filling element: panel or glass, depending on the model (4 mm thick)
- 3** the frame is made of an MDF board
- 4** door leaf covered with ENDURO foil or ECO-VENEER
 - side edges and upper edge are foiled
 - rounded vertical edges of door leaves (more info on p. 122)
 - double door leaves have a rebate and a counter-rebate (drawing on p. 122)
 - width of single doors: "60"-"100" / width of double doors: "120"-"200"



STANDARD EQUIPMENT

- | | |
|-------------|--|
| rebated | <ul style="list-style-type: none"> • lock 72 mm for a standard key, a WC knob, or a cylinder lock insert • screw-in pivot hinges 13.5/9 (white zinc)—2 pcs for door leaves in sizes "60"-"80", 3 pcs for door leaves in sizes "90" and "100" |
| non-rebated | <ul style="list-style-type: none"> • magnetic lock 90 mm for a standard key, 95 mm for a WC knob, and 85 mm for a cylinder lock insert • hidden hinges with a 3D regulation in the colour satin chrome |

DEDICATED DOOR FRAMES

- **[OB3]** block door frame (possibility to add an architrave 10 x 60 mm or 16 x 80 mm) **P. 125**
- **[ORS1]** adjustable door frame for rebated doors with a flat angle architrave 60 mm-wide **P. 126**
- **[ORS8]** adjustable door frame for rebated doors with a flat angle architrave 80 mm-wide **P. 126**
- **[ORS7]** adjustable door frame for modular non-rebated doors with a flat angle architrave 60 mm-wide **P. 127**
- **[ORS10]** adjustable door frame for modular non-rebated doors with a flat angle architrave 80 mm-wide **P. 127**
- **[ORS4]** adjustable 90° door frame for modular non-rebated doors with a flat angle architrave 80 mm-wide **P. 127**
- NOTE: THE OFFER ALSO INCLUDES METAL DOOR FRAMES **P. 128-129**

ADDITIONAL OPTIONS

- door without a keyhole no extra charge
- door width "100"
- additional hinge for the door in sizes "60"-"80"
- additional hinge for the non-rebated door—included in a door frame
- caps for hinges (chrome, satin chrome, golden, black)—set for 1 hinge unit
- ventilation undercut
- PVC ventilation sleeves
- metal ventilation sleeves, round (chrome, golden)
- metal ventilation sleeves, square (chrome, nickel)
- door made in a non-rebated version for sliding systems
- door made in non-rebated version
- double door
- cylinder lock insert 31/36 (31/31 in non-rebated door leaves)
- automatic bottom door seal, widths "60"-"100"
- aluminium threshold, widths "60"-"100"

Additional information: equipment and accessories

P. 133-137

GLASS

the glossy side of glass is on the hinge side



Rebated Versano 6 in B490



www.invado.pl

DOOR LEAVES OPTIONS

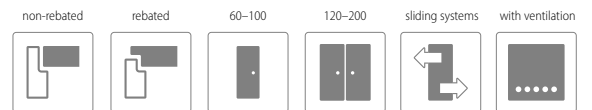

DECORS

ENDURO **



ENDURO 3D **



LAMINOLACK ****



ENDURO PLUS **



ECO-VENEER FORTE ***



ECO-VENEER CPL ***





CONSTRUCTION

- 1** filling element: 22 mm thick panel
- 2** filling element: panel or glass, depending on the model (4 mm thick)
- 2** the frame is made of an MDF board: upper part of the frame is 350 mm high, lower part of the frame is 400 mm high
- 4** door leaf covered with ENDURO foil or ECO-VENEER
 - side edges and upper edge are foiled
 - rounded vertical edges of door leaves (more info on p. 122)
 - double door leaves have a rebate and a counter-rebate (drawing on p. 122)
 - width of single doors: "60"–"100" / width of double doors: "120"–"200"

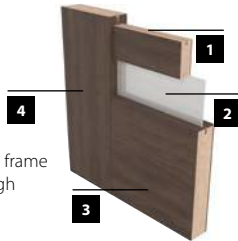

STANDARD EQUIPMENT

- | | |
|-------------|--|
| rebated | <ul style="list-style-type: none"> • lock 72 mm for a standard key, a WC knob, or a cylinder lock insert • screw-in pivot hinges 13.5/9 (white zinc)—2 pcs for door leaves in sizes "60"–"80", 3 pcs for door leaves in sizes "90" and "100" |
| non-rebated | <ul style="list-style-type: none"> • magnetic lock 90 mm for a standard key, 95 mm for a WC knob, and 85 mm for a cylinder lock insert • hidden hinges with a 3D regulation in the colour satin chrome |

DEDICATED DOOR FRAMES

- **[OB3]** block door frame (possibility to add an architrave 10 x 60 mm or 16 x 80 mm) **P. 125**
- **[ORS1]** adjustable door frame for rebated doors with a flat angle architrave 60 mm-wide **P. 126**
- **[ORS8]** adjustable door frame for rebated doors with a flat angle architrave 80 mm-wide **P. 126**
- **[ORS7]** adjustable door frame for modular non-rebated doors with a flat angle architrave 60 mm-wide **P. 127**
- **[ORS10]** adjustable door frame for modular non-rebated doors with a flat angle architrave 80 mm-wide **P. 127**
- **[ORS4]** adjustable 90° door frame for modular non-rebated doors with a flat angle architrave 80 mm-wide **P. 127**
- NOTE: THE OFFER ALSO INCLUDES METAL DOOR FRAMES **P. 128-129**

ADDITIONAL OPTIONS

- door without a keyhole no extra charge
- door width "100"
- additional hinge for the door in sizes "60"–"80"
- additional hinge for the non-rebated door—included in a door frame
- caps for hinges (chrome, satin chrome, golden, black)—set for 1 hinge unit
- ventilation undercut
- PVC ventilation sleeves
- metal ventilation sleeves, round (chrome, golden)
- metal ventilation sleeves, square (chrome, nickel)
- door made in a non-rebated version for sliding systems
- door made in non-rebated version
- double door
- cylinder lock insert 31/36 (31/31 in non-rebated door leaves)
- automatic bottom door seal, widths "60"–"100"
- aluminium threshold, widths "60"–"100"

Additional information: equipment and accessories

P. 133–137

GLASS

the glossy side of glass is on the hinge side



Non-rebated Nogaro 2 in B708



www.invado.pl



WATCH THE ASSEMBLY VIDEOS ON OUR YOUTUBE CHANNEL

DOOR LEAVES OPTIONS

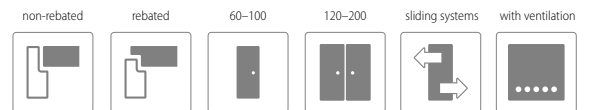

DECORS

ENDURO **

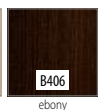

ENDURO 3D **

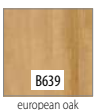

LAMINOLACK **** NEW

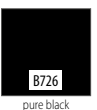
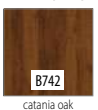

ENDURO PLUS **



ECO-VENEER FORTE ***



ECO-VENEER CPL ***





CONSTRUCTION

- 1** filling element: 22 mm thick panel
- 2** filling element: panel or glass, depending on the model (4 mm thick)
- 3** the frame is made of an MDF board
- 4** door leaf covered with ENDURO foil, ECO-VENEER or LAMINOLACK
 - side edges and upper edge are foiled
 - rounded vertical edges of door leaves (more info on p. 122)
 - double door leaves have a rebate and a counter-rebate (drawing on p. 122)
 - width of single doors: "60"-"100" / width of double doors: "120"-"200"



ADDITIONAL OPTIONS

- door without a keyhole no extra charge
- door width "100"
- additional hinge for the door in sizes "60"-"80"
- additional hinge for the non-rebated door—included in a door frame
- caps for hinges (chrome, satin chrome, golden, black)—set for 1 hinge unit
- ventilation undercut
- PVC ventilation sleeves
- metal ventilation sleeves, round (chrome, golden)
- metal ventilation sleeves, square (chrome, nickel)
- door made in a non-rebated version for sliding systems
- door made in non-rebated version
- double door
- cylinder lock insert 31/36 (31/31 in non-rebated door leaves)
- automatic bottom door seal, widths "60"-"100"
- aluminium threshold, widths "60"-"100"

Additional information: equipment and accessories

P. 133-137

STANDARD EQUIPMENT

- | | |
|-------------|--|
| rebated | <ul style="list-style-type: none"> • lock 72 mm for a standard key, a WC knob, or a cylinder lock insert • screw-in pivot hinges 13.5/9 (white zinc)—2 pcs for door leaves in sizes "60"-"80", 3 pcs for door leaves in sizes "90" and "100" |
| non-rebated | <ul style="list-style-type: none"> • magnetic lock 90 mm for a standard key, 95 mm for a WC knob, and 85 mm for a cylinder lock insert • hidden hinges with a 3D regulation in the colour satin chrome |

DEDICATED DOOR FRAMES

- **[OB3]** block door frame (possibility to add an architrave 10 x 60 mm or 16 x 80 mm) P. 125
- **[ORS1]** adjustable door frame for rebated doors with a flat angle architrave 60 mm-wide P. 126
- **[ORS8]** adjustable door frame for rebated doors with a flat angle architrave 80 mm-wide P. 126
- **[ORS7]** adjustable door frame for modular non-rebated doors with a flat angle architrave 60 mm-wide P. 127
- **[ORS10]** adjustable door frame for modular non-rebated doors with a flat angle architrave 80 mm-wide P. 127
- **[ORS4]** adjustable 90° door frame for modular non-rebated doors with a flat angle architrave 80 mm-wide P. 127
- NOTE: THE OFFER ALSO INCLUDES METAL DOOR FRAMES P. 128-129

GLASS

the glossy side of glass is on the hinge side





Rebated Tamparo 2 in B708

www.invado.pl



WATCH THE ASSEMBLY VIDEOS ON OUR YOUTUBE CHANNEL

DOOR LEAVES OPTIONS

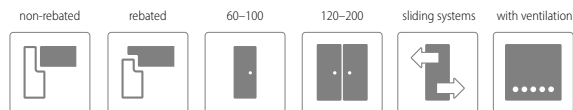

DECORS

ENDURO **			ENDURO 3D **				LAMINOLACK **** NEW						
ENDURO PLUS **	ECO-VENEER FORTE ***			ECO-VENEER CPL ***									

Tamparo 1



Tamparo 2



Tamparo 3



NEW Tamparo 4



CONSTRUCTION

- 1** filling element: 22 mm thick panel
- 2** filling element: panel or glass, depending on the model (4 mm thick). Model 4 has black panels in B726
- 3** the frame is made of an MDF board
- 4** door leaf covered with ENDURO foil, ECO-VENEER or LAMINOLACK
 - side edges and upper edge are foiled
 - rounded vertical edges of door leaves (more info on p. 122)
 - double door leaves have a rebate and a counter-rebate (drawing on p. 122)
 - width of single doors: "60"-"100" / width of double doors: "120"-"200"



STANDARD EQUIPMENT

- | | |
|-------------|--|
| rebated | <ul style="list-style-type: none"> • lock 72 mm for a standard key, a WC knob, or a cylinder lock insert • screw-in pivot hinges 13.5/9 (white zinc)—2 pcs for door leaves in sizes "60"-"80", 3 pcs for door leaves in sizes "90" and "100" |
| non-rebated | <ul style="list-style-type: none"> • magnetic lock 90 mm for a standard key, 95 mm for a WC knob, and 85 mm for a cylinder lock insert • hidden hinges with a 3D regulation in the colour satin chrome |

DEDICATED DOOR FRAMES

- **[OB3]** block door frame (possibility to add an architrave 10 x 60 mm or 16 x 80 mm) **P. 125**
- **[ORS1]** adjustable door frame for rebated doors with a flat angle architrave 60 mm-wide **P. 126**
- **[ORS8]** adjustable door frame for rebated doors with a flat angle architrave 80 mm-wide **P. 126**
- **[ORS7]** adjustable door frame for modular non-rebated doors with a flat angle architrave 60 mm-wide **P. 127**
- **[ORS10]** adjustable door frame for modular non-rebated doors with a flat angle architrave 80 mm-wide **P. 127**
- **[ORS4]** adjustable 90° door frame for modular non-rebated doors with a flat angle architrave 80 mm-wide **P. 127**
- NOTE: THE OFFER ALSO INCLUDES METAL DOOR FRAMES **P. 128-129**

ADDITIONAL OPTIONS

- door without a keyhole no extra charge
- door width "100"
- additional hinge for the door in sizes "60"-"80"
- additional hinge for the non-rebated door—included in a door frame
- caps for hinges (chrome, satin chrome, golden, black)—set for 1 hinge unit
- ventilation undercut
- PVC ventilation sleeves
- metal ventilation sleeves, round (chrome, golden)
- metal ventilation sleeves, square (chrome, nickel)
- door made in a non-rebated version for sliding systems
- door made in non-rebated version
- double door
- cylinder lock insert 31/36 (31/31 in non-rebated door leaves)
- automatic bottom door seal, widths "60"-"100"
- aluminium threshold, widths "60"-"100"

Additional information: equipment and accessories

P. 133-137

GLASS

the glossy side of glass is on the hinge side



Rebated Linea Forte 5 in B705



WATCH THE ASSEMBLY VIDEOS ON OUR YOUTUBE CHANNEL

DOOR LEAVES OPTIONS

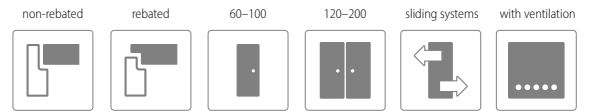

DECORS

ENDURO **



ENDURO 3D **



LAMINOLACK **** NEW



ENDURO PLUS **



ECO-VENEER FORTE ***



ECO-VENEER CPL ***





CONSTRUCTION

- 1** filling element: 22 mm thick panel
- 2** filling element: panel or glass, depending on the model (4 mm thick). Models 7 and 8 have black panels in B726
- 3** the frame is made of an MDF board
- 4** door leaf covered with ENDURO foil, ECO-VENEER or LAMINOLACK
 - side edges and upper edge are foiled
 - rounded vertical edges of door leaves (more info on p. 122)
 - double door leaves have a rebate and a counter-rebate (drawing on p. 122)
 - width of single doors: "60"-"100" / width of double doors: "120"-"200"

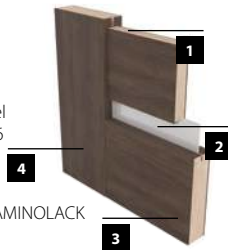

ADDITIONAL OPTIONS

- door without a keyhole no extra charge
- door width "100"
- additional hinge for the door in sizes "60"-"80"
- additional hinge for the non-rebated door—included in a door frame
- caps for hinges (chrome, satin chrome, golden, black)—set for 1 hinge unit
- ventilation undercut
- PVC ventilation sleeves
- metal ventilation sleeves, round (chrome, golden)
- metal ventilation sleeves, square (chrome, nickel)
- door made in a non-rebated version for sliding systems
- door made in non-rebated version
- double door
- cylinder lock insert 31/36 (31/31 in non-rebated door leaves)
- automatic bottom door seal, widths "60"-"100"
- aluminium threshold, widths "60"-"100"

Additional information: equipment and accessories

P. 133-137

STANDARD EQUIPMENT

- | | |
|-------------|--|
| rebated | <ul style="list-style-type: none"> • lock 72 mm for a standard key, a WC knob, or a cylinder lock insert • screw-in pivot hinges 13.5/9 (white zinc)—2 pcs for door leaves in sizes "60"-"80", 3 pcs for door leaves in sizes "90" and "100" |
| non-rebated | <ul style="list-style-type: none"> • magnetic lock 90 mm for a standard key, 95 mm for a WC knob, and 85 mm for a cylinder lock insert • hidden hinges with a 3D regulation in the colour satin chrome |

DEDICATED DOOR FRAMES

- **[OB3]** block door frame (possibility to add an architrave 10 x 60 mm or 16 x 80 mm) P. 125
- **[ORS1]** adjustable door frame for rebated doors with a flat angle architrave 60 mm-wide P. 126
- **[ORS8]** adjustable door frame for rebated doors with a flat angle architrave 80 mm-wide P. 126
- **[ORS7]** adjustable door frame for modular non-rebated doors with a flat angle architrave 60 mm-wide P. 127
- **[ORS10]** adjustable door frame for modular non-rebated doors with a flat angle architrave 80 mm-wide P. 127
- **[ORS4]** adjustable 90° door frame for modular non-rebated doors with a flat angle architrave 80 mm-wide P. 127
- NOTE: THE OFFER ALSO INCLUDES METAL DOOR FRAMES P. 128-129

GLASS

the glossy side of glass is on the hinge side





Rebated Capena Inserto 3 in B637



WATCH THE ASSEMBLY VIDEOS ON OUR YOUTUBE CHANNEL

DOOR LEAVES OPTIONS

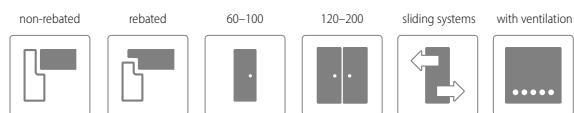

DECORS

ENDURO **



ENDURO 3D **



ENDURO PLUS **



ECO-VENEER FORTE ***



LAMINOLACK ****



ECO-VENEER CPL ***



Capena Inserto 1



Capena Inserto 2



Capena Inserto 3



Capena Inserto 4



Capena Inserto 5



CONSTRUCTION

- 1** filling element: panel or glass, depending on the model (4 mm thick)
- 2** filling element: 22 mm thick panel
- 3** the frame is made of an MDF board
- 4** ALU strip—8 mm
- 5** door leaf covered with ENDURO foil or ECO-VENEER
 - side edges and upper edge are foiled
 - rounded vertical edges of door leaves (more info on p. 122)
 - double door leaves have a rebate and a counter-rebate (drawing on p. 122)
 - width of single doors: "60"–"100" / width of double doors: "120"–"200"

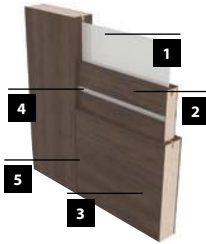

STANDARD EQUIPMENT

- | | |
|-------------|--|
| rebated | <ul style="list-style-type: none"> • lock 72 mm for a standard key, a WC knob, or a cylinder lock insert • screw-in pivot hinges 13.5/9 (white zinc)—2 pcs for door leaves in sizes "60"–"80", 3 pcs for door leaves in sizes "90" and "100" |
| non-rebated | <ul style="list-style-type: none"> • magnetic lock 90 mm for a standard key, 95 mm for a WC knob, and 85 mm for a cylinder lock insert • hidden hinges with a 3D regulation in the colour satin chrome |

DEDICATED DOOR FRAMES

- **[OB3]** block door frame (possibility to add an architrave 10 x 60 mm or 16 x 80 mm) **P. 125**
- **[ORS1]** adjustable door frame for rebated doors with a flat angle architrave 60 mm-wide **P. 126**
- **[ORS8]** adjustable door frame for rebated doors with a flat angle architrave 80 mm-wide **P. 126**
- **[ORS7]** adjustable door frame for modular non-rebated doors with a flat angle architrave 60 mm-wide **P. 127**
- **[ORS10]** adjustable door frame for modular non-rebated doors with a flat angle architrave 80 mm-wide **P. 127**
- **[ORS4]** adjustable 90° door frame for modular non-rebated doors with a flat angle architrave 80 mm-wide **P. 127**
- NOTE: THE OFFER ALSO INCLUDES METAL DOOR FRAMES **P. 128-129**

ADDITIONAL OPTIONS

- door without a keyhole no extra charge
- door width "100"
- additional hinge for the door in sizes "60"–"80"
- additional hinge for the non-rebated door—included in a door frame
- caps for hinges (chrome, satin chrome, golden, black)—set for 1 hinge unit
- ventilation undercut
- PVC ventilation sleeves
- metal ventilation sleeves, round (chrome, golden)
- metal ventilation sleeves, square (chrome, nickel)
- door made in a non-rebated version for sliding systems
- door made in non-rebated version
- double door
- cylinder lock insert 31/36 (31/31 in non-rebated door leaves)
- automatic bottom door seal, widths "60"–"100"
- aluminium threshold, widths "60"–"100"

Additional information: equipment and accessories

P. 133-137

GLASS

the glossy side of glass is on the hinge side



Non-rebated Martina 5 in B462



www.invado.pl



WATCH THE ASSEMBLY VIDEOS ON OUR YOUTUBE CHANNEL

DOOR LEAVES OPTIONS

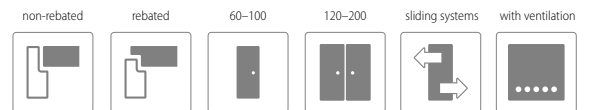

DECORS

ENDURO **



ENDURO 3D **



LAMINOLACK ****

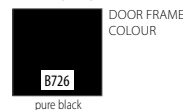

ENDURO PLUS **



ECO-VENEER FORTE ***



ECO-VENEER CPL ***



Martina 1



Martina 2



Martina 3



Martina 4



Martina 5



CONSTRUCTION

- 1** filling element: 22 mm thick panel
- 2** filling element: panel or glass, depending on the model (4 mm thick)
- 3** the frame is made of an MDF board
- 4** door leaf covered with ENDURO foil or ECO-VENEER
 - side edges and upper edge are foiled
 - rounded vertical edges of door leaves (more info on p. 122)
 - double door leaves have a rebate and a counter-rebate (drawing on p. 122)
 - width of single doors: "60"–"100" / width of double doors: "120"–"200"



STANDARD EQUIPMENT

- | | |
|-------------|--|
| rebated | <ul style="list-style-type: none"> • lock 72 mm for a standard key, a WC knob, or a cylinder lock insert • screw-in pivot hinges 13.5/9 (white zinc)—2 pcs for door leaves in sizes "60"–"80", 3 pcs for door leaves in sizes "90" and "100" |
| non-rebated | <ul style="list-style-type: none"> • magnetic lock 90 mm for a standard key, 95 mm for a WC knob, and 85 mm for a cylinder lock insert • hidden hinges with a 3D regulation in the colour satin chrome |

DEDICATED DOOR FRAMES

- **[OB3]** block door frame (possibility to add an architrave 10 x 60 mm or 16 x 80 mm) **P. 125**
- **[ORS1]** adjustable door frame for rebated doors with a flat angle architrave 60 mm-wide **P. 126**
- **[ORS8]** adjustable door frame for rebated doors with a flat angle architrave 80 mm-wide **P. 126**
- **[ORS7]** adjustable door frame for modular non-rebated doors with a flat angle architrave 60 mm-wide **P. 127**
- **[ORS10]** adjustable door frame for modular non-rebated doors with a flat angle architrave 80 mm-wide **P. 127**
- **[ORS4]** adjustable 90° door frame for modular non-rebated doors with a flat angle architrave 80 mm-wide **P. 127**
- NOTE: THE OFFER ALSO INCLUDES METAL DOOR FRAMES **P. 128-129**

ADDITIONAL OPTIONS

- door without a keyhole **no extra charge**
- door width "100"
- additional hinge for the door in sizes "60"–"80"
- additional hinge for the non-rebated door—included in a door frame
- caps for hinges (chrome, satin chrome, golden, black)—set for 1 hinge unit
- ventilation undercut
- PVC ventilation sleeves
- metal ventilation sleeves, round (chrome, golden)
- metal ventilation sleeves, square (chrome, nickel)
- door made in a non-rebated version for sliding systems
- door made in non-rebated version
- double door
- cylinder lock insert 31/36 (31/31 in non-rebated door leaves)
- automatic bottom door seal, widths "60"–"100"
- aluminium threshold, widths "60"–"100"

Additional information: equipment and accessories

P. 133-137

GLASS

the glossy side of glass is on the hinge side





Rebated Domino 17 in B598

www.invado.pl



WATCH THE ASSEMBLY VIDEOS ON OUR YOUTUBE CHANNEL

DOOR LEAVES OPTIONS

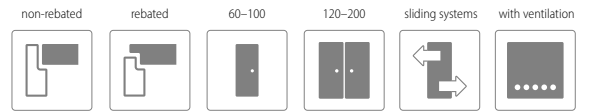

DECORS

ENDURO **

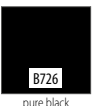
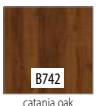
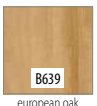
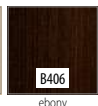

ENDURO 3D **

LAMINOLACK **** NEW

ENDURO PLUS **

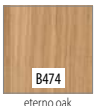

ECO-VENEER FORTE ***

ECO-VENEER CPL ***



DOMINO 3-4, 8, 15-19 ARE NOT AVAILABLE IN DECORS: B739, B726, B741, B743, B744, B742

KONSTRUKCJA

- 1** filling element: 10 mm thick panel
- 2** filling element: panel or glass, depending on the model (4 mm thick)
- 3** the frame is made of an MDF board
- 4** door leaf covered with ENDURO foil or ECO-VENEER
 - side edges and upper edge are foiled
 - rounded vertical edges of door leaves (more info on p. 122)
 - double door leaves have a rebate and a counter-rebate (drawing on p. 122)
 - width of single doors: "60"- "100" / width of double doors: "120"- "200"

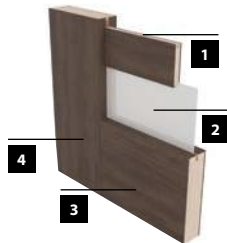

ADDITIONAL OPTIONS

- door without a keyhole no extra charge
- door width "100"
- additional hinge for the door in sizes "60"- "80"
- additional hinge for the non-rebated door—included in a door frame
- caps for hinges (chrome, satin chrome, golden, black)—set for 1 hinge unit
- ventilation undercut
- PVC ventilation sleeves
- metal ventilation sleeves, round (chrome, golden)
- metal ventilation sleeves, square (chrome, nickel)
- door made in a non-rebated version for sliding systems
- door made in non-rebated version
- double door
- cylinder lock insert 31/36 (31/31 in non-rebated door leaves)
- automatic bottom door seal, widths "60"- "100"
- aluminium threshold, widths "60"- "100"

Additional information: equipment and accessories

P. 133-137

STANDARD EQUIPMENT

- | | |
|-------------|---|
| rebated | <ul style="list-style-type: none"> • lock 72 mm for a standard key, a WC knob, or a cylinder lock insert • screw-in pivot hinges 13.5/9 (white zinc)—2 pcs for door leaves in sizes "60"- "80", 3 pcs for door leaves in sizes "90" and "100" |
| non-rebated | <ul style="list-style-type: none"> • magnetic lock 90 mm for a standard key, 95 mm for a WC knob, and 85 mm for a cylinder lock insert • hidden hinges with a 3D regulation in the colour satin chrome |

DEDICATED DOOR FRAMES

- **[OB3]** block door frame (possibility to add an architrave 10 x 60 mm or 16 x 80 mm) P. 125
- **[ORS1]** adjustable door frame for rebated doors with a flat angle architrave 60 mm-wide P. 126
- **[ORS8]** adjustable door frame for rebated doors with a flat angle architrave 80 mm-wide P. 126
- **[ORS7]** adjustable door frame for modular non-rebated doors with a flat angle architrave 60 mm-wide P. 127
- **[ORS10]** adjustable door frame for modular non-rebated doors with a flat angle architrave 80 mm-wide P. 127
- **[ORS4]** adjustable 90° door frame for modular non-rebated doors with a flat angle architrave 80 mm-wide P. 127
- NOTE: THE OFFER ALSO INCLUDES METAL DOOR FRAMES P. 128-129

GLASS

the glossy side of glass is on the hinge side



Rebated Bianco NEVE 2 in B490



www.invado.pl



WATCH THE ASSEMBLY VIDEOS ON OUR YOUTUBE CHANNEL

DOOR LEAVES OPTIONS

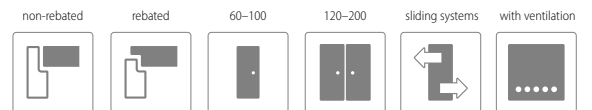

DECORS

ECO-VENEER CPL ...



B490

white

NEW

LAMINOLACK



B739

pure white

LAMINOLACK



B726

pure black

DOOR FRAME COLOUR



CONSTRUCTION

- 1** filling element: 33 mm thick panel
- 2** filling element: panel (10 mm thick) or glass (4 mm thick) depending on the model
- 3** the frame is made of an MDF board
- 4** door leaf covered with ECO-VENEER or LAMINOLACK
 - side edges and upper edge are foiled
 - rounded vertical edges of door leaves (more info on p. 122)
 - double door leaves have a rebate and a counter-rebate (drawing on p. 122)
 - width of single doors: "60"- "100" / width of double doors: "120"- "200"

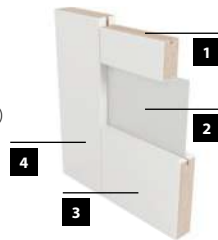

STANDARD EQUIPMENT

- | | |
|-------------|---|
| rebated | <ul style="list-style-type: none"> • lock 72 mm for a standard key, a WC knob, or a cylinder lock insert • screw-in pivot hinges 13.5/9 (white zinc)—2 pcs for door leaves in sizes "60"- "80", 3 pcs for door leaves in sizes "90" and "100" |
| non-rebated | <ul style="list-style-type: none"> • magnetic lock 90 mm for a standard key, 95 mm for a WC knob, and 85 mm for a cylinder lock insert • hidden hinges with a 3D regulation in the colour satin chrome |

DEDICATED DOOR FRAMES

- | | |
|---|------------|
| • [OB3] block door frame (possibility to add an architrave 10 x 60 mm or 16 x 80 mm) | P. 125 |
| • [ORS1] adjustable door frame for rebated doors with a flat angle architrave 60 mm-wide | P. 126 |
| • [ORS8] adjustable door frame for rebated doors with a flat angle architrave 80 mm-wide | P. 126 |
| • [ORS7] adjustable door frame for modular non-rebated doors with a flat angle architrave 60 mm-wide | P. 127 |
| • [ORS10] adjustable door frame for modular non-rebated doors with a flat angle architrave 80 mm-wide | P. 127 |
| • [ORS4] adjustable 90° door frame for modular non-rebated doors with a flat angle architrave 80 mm-wide | P. 127 |
| • NOTE: THE OFFER ALSO INCLUDES METAL DOOR FRAMES | P. 128-129 |

ADDITIONAL OPTIONS

- door without a keyhole no extra charge
- door width "100"
- additional hinge for the door in sizes "60"- "80"
- additional hinge for the non-rebated door—included in a door frame
- caps for hinges (chrome, satin chrome, golden, black)—set for 1 hinge unit
- ventilation undercut
- PVC ventilation sleeves
- metal ventilation sleeves, round (chrome, golden)
- metal ventilation sleeves, square (chrome, nickel)
- door made in a non-rebated version for sliding systems
- door made in non-rebated version
- double door
- cylinder lock insert 31/36 (31/31 in non-rebated door leaves)
- automatic bottom door seal, widths "60"- "100"
- aluminium threshold, widths "60"- "100"

Additional information: equipment and accessories

P. 133-137

GLASS

the glossy side of glass is on the hinge side



Rebated Larina NUBE 2 in B587



WATCH THE ASSEMBLY VIDEOS ON OUR YOUTUBE CHANNEL

DOOR LEAVES OPTIONS

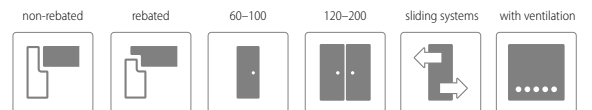

DECORS

ENDURO **

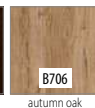
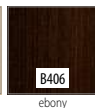

ENDURO 3D **

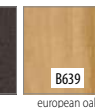
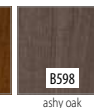
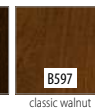
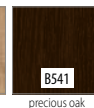

LAMINOLACK **** NEW

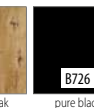
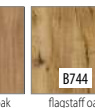
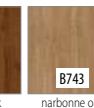
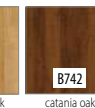

ENDURO PLUS **



ECO-VENEER FORTE ***

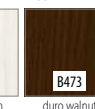



CONSTRUCTION

- 1** filling element: 35 mm thick panel
- 2** filling element: panel (10 mm thick) or glass (4 mm thick) depending on the model
- 3** the frame is made of an MDF board
- 4** door leaf covered with ENDURO foil, ECO-VENEER or LAMINOLACK
 - side edges and upper edge are foiled
 - rounded vertical edges of door leaves (more info on p. 122)
 - double door leaves have a rebate and a counter-rebate (drawing on p. 122)
 - width of single doors: "60"-"100" / width of double doors: "120"-"200"



STANDARD EQUIPMENT

- | | |
|-------------|--|
| rebated | <ul style="list-style-type: none"> • lock 72 mm for a standard key, a WC knob, or a cylinder lock insert • screw-in pivot hinges 13.5/9 (white zinc)—2 pcs for door leaves in sizes "60"-"80", 3 pcs for door leaves in sizes "90" and "100" |
| non-rebated | <ul style="list-style-type: none"> • magnetic lock 90 mm for a standard key, 95 mm for a WC knob, and 85 mm for a cylinder lock insert • hidden hinges with a 3D regulation in the colour satin chrome |

DEDICATED DOOR FRAMES

- | | |
|--|------------|
| • [OB3] block door frame (possibility to add an architrave 10 x 60 mm or 16 x 80 mm) | P. 125 |
| • [ORS1] adjustable door frame for rebated doors with a flat angle architrave 60 mm-wide | P. 126 |
| • [ORS8] adjustable door frame for rebated doors with a flat angle architrave 80 mm-wide | P. 126 |
| • [ORS7] adjustable door frame for modular non-rebated doors with a flat angle architrave 60 mm-wide | P. 127 |
| • [ORS10] adjustable door frame for modular non-rebated doors with a flat angle architrave 80 mm-wide | P. 127 |
| • [ORS4] adjustable 90° door frame for modular non-rebated doors with a flat angle architrave 80 mm-wide | P. 127 |
| • NOTE: THE OFFER ALSO INCLUDES METAL DOOR FRAMES | P. 128-129 |

ADDITIONAL OPTIONS

- door without a keyhole no extra charge
- door width "100"
- additional hinge for the door in sizes "60"-"80"
- additional hinge for the non-rebated door—included in a door frame
- caps for hinges (chrome, satin chrome, golden, black)—set for 1 hinge unit
- ventilation undercut
- PVC ventilation sleeves
- metal ventilation sleeves, round (chrome, golden)
- metal ventilation sleeves, square (chrome, nickel)
- door made in a non-rebated version for sliding systems
- door made in non-rebated version
- double door
- cylinder lock insert 31/36 (31/31 in non-rebated door leaves)
- automatic bottom door seal, widths "60"-"100"
- aluminium threshold, widths "60"-"100"

Additional information: equipment and accessories

P. 133-137

GLASS

the glossy side of glass is on the hinge side



Rebated D'Artagnan 1 in B708



WATCH THE ASSEMBLY VIDEOS ON OUR YOUTUBE CHANNEL

DOOR LEAVES OPTIONS

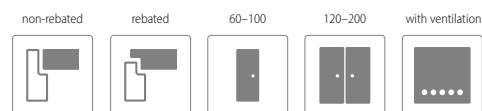

DECORS

ENDURO **



ENDURO 3D **



ENDURO PLUS **



ECO-VENEER FORTE ***



ECO-VENEER CPL ***



LAMINOLACK ****

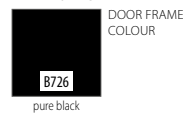

DOOR FRAME COLOUR

D'Artagnan 1



D'Artagnan INTERO



D'Artagnan 7 TONDO



CONSTRUCTION

- 1** frame is made of finger joint pinewood, covered with MDF and HDF boards
- 2** filling element: panel (10 mm thick) or glass (6 mm thick) depending on the model
- 3** door leaf covered with ENDURO foil or ECO-VENEER
 - side edges and upper edge are foiled
 - rounded vertical edges of door leaves (more info on p. 122)
 - double door leaves have a rebate and a counter-rebate (drawing on p. 122)
 - width of single doors: "60"- "100" / width of double doors: "120"- "200"

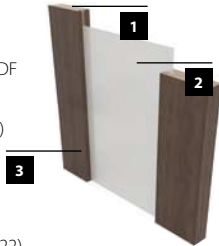

ADDITIONAL OPTIONS

- door without a keyhole no extra charge
- door width "100"
- additional hinge for the door in sizes "60"- "80"
- additional hinge for the non-rebated door—included in a door frame
- caps for hinges (chrome, satin chrome, golden, black)—set for 1 hinge unit
- ventilation undercut (INTERO model)
- door made in non-rebated version
- double door
- cylinder lock insert 31/36 (31/31 in non-rebated door leaves)

Additional information: equipment and accessories

P. 133-137

STANDARD EQUIPMENT

- | | |
|-------------|---|
| rebated | <ul style="list-style-type: none"> • lock 72 mm for a standard key, a WC knob, or a cylinder lock insert • screw-in pivot hinges 13.5/9 (white zinc)—2 pcs for door leaves in sizes "60"- "80", 3 pcs for door leaves in sizes "90" and "100" |
| non-rebated | <ul style="list-style-type: none"> • magnetic lock 90 mm for a standard key, 95 mm for a WC knob, and 85 mm for a cylinder lock insert • hidden hinges with a 3D regulation in the colour satin chrome |

DEDICATED DOOR FRAMES

- **[OB3]** block door frame (possibility to add an architrave 10 x 60 mm or 16 x 80 mm) P. 125
- **[ORS1]** adjustable door frame for rebated doors with a flat angle architrave 60 mm-wide P. 126
- **[ORS8]** adjustable door frame for rebated doors with a flat angle architrave 80 mm-wide P. 126
- **[ORS7]** adjustable door frame for modular non-rebated doors with a flat angle architrave 60 mm-wide P. 127
- **[ORS10]** adjustable door frame for modular non-rebated doors with a flat angle architrave 80 mm-wide P. 127
- **[ORS4]** adjustable 90° door frame for modular non-rebated doors with a flat angle architrave 80 mm-wide P. 127
- NOTE: THE OFFER ALSO INCLUDES METAL DOOR FRAMES P. 128-129

GLASS

the matt (engraved) side of glass is located on the hinge side



longer execution time

longer execution time

COLLECTION OF
FOILED DOORS

Salerno	60
Norma Decor	62
Torino	64
Merano	66
Lido	68
Dolce	70
Strada	72
Sagittarius	74
Gemini	76
Virgo	78
Parma	80
Orso	82
Libra	84
Taurus	84





Rebated Salerno 3 in B596



WATCH THE ASSEMBLY VIDEOS ON OUR YOUTUBE CHANNEL

DOOR LEAVES OPTIONS

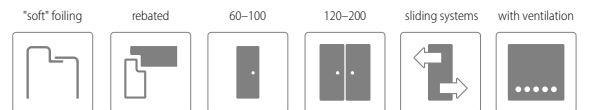

DECORS

ENDURO **

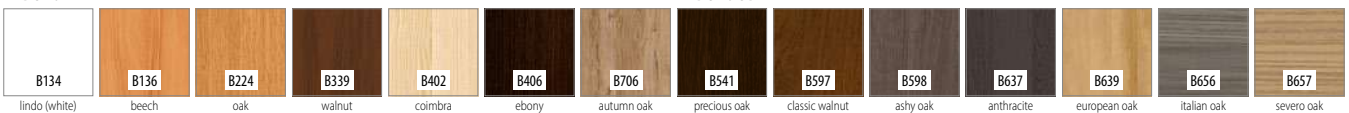

ENDURO 3D **

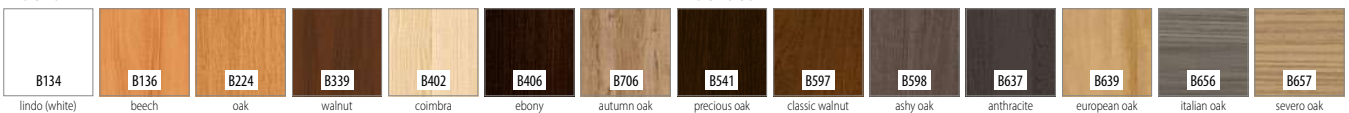

ENDURO PLUS **

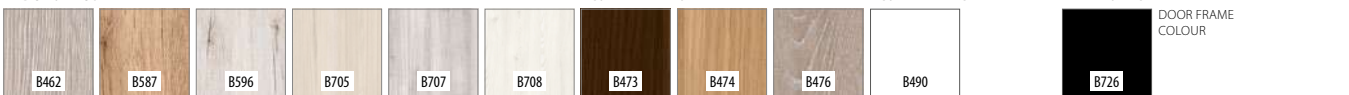

ECO-VENEER FORTE ***



ECO-VENEER CPL ***

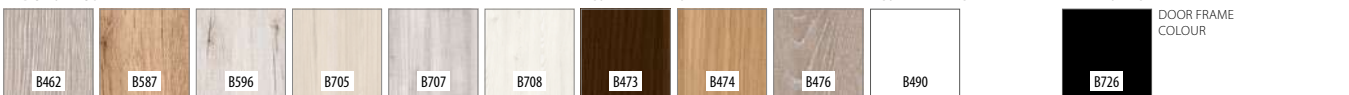

LAMINOLACK ****

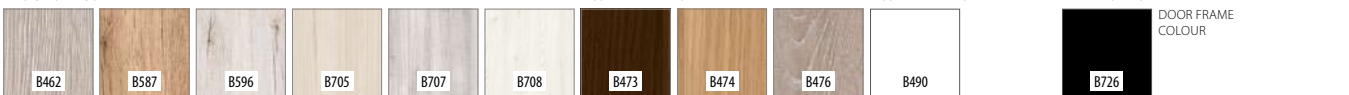

DOOR FRAME COLOUR



CONSTRUCTION

- 1** the frame is made of an MDF board
- 2** (STANDARD) "honeycomb" filling
- 3** (OPTIONAL) tubular chipboard filling
- 4** frame with filling is covered with HDF boards on both sides
- 5** door leaf covered with ENDURO foil or ECO-VENEER
 - side edges and upper edge are foiled
 - rounded vertical edges of door leaves (more info on p. 122)
 - double door leaves have a rebate and a counter-rebate (drawing on p. 122)
 - width of single doors: "60"-"100" / width of double doors: "120"-"200"

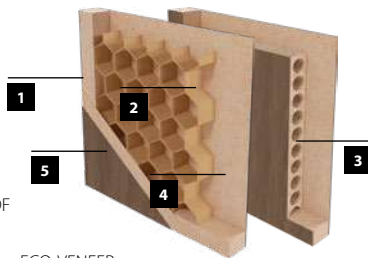

ADDITIONAL OPTIONS

- door without a keyhole no extra charge
- door width "100"
- additional hinge for the door in sizes "60"-"80"
- caps for hinges (chrome, satin chrome, golden, black)—set for 1 hinge unit
- ventilation undercut
- PVC ventilation sleeves
- metal ventilation sleeves, round (chrome, golden)
- metal ventilation sleeves, square (chrome, nickel)
- door made in a non-rebated version for sliding systems
- double door
- cylinder lock insert 31/36
- tubular chipboard filling
- automatic bottom door seal, widths "60"-"100"
- aluminium threshold, widths "60"-"100"

Additional information: equipment and accessories

P. 133-137

STANDARD EQUIPMENT

- lock 72 mm for a standard key, a WC knob, or a cylinder lock insert
- screw-in pivot hinges 13.5/9 (white zinc)—2 pcs for door leaves in sizes "60"-"80", 3 pcs for door leaves in sizes "90" and "100"

DEDICATED DOOR FRAMES

- [OB3] block door frame (possibility to add an architrave 10 x 60 mm or 16 x 80 mm) P. 125
- [ORS1] adjustable door frame for rebated doors with a flat angle architrave 60 mm-wide P. 126
- [ORS8] adjustable door frame for rebated doors with a flat angle architrave 80 mm-wide P. 126
- NOTE: THE OFFER ALSO INCLUDES METAL DOOR FRAMES P. 128-129

GLASS

the glossy side of glass is on the hinge side



Rebated Norma Decor 1 in B134



WATCH THE ASSEMBLY VIDEOS ON OUR YOUTUBE CHANNEL

DOOR LEAVES OPTIONS

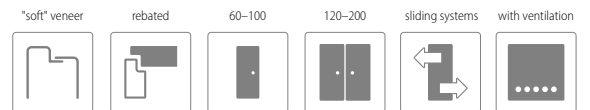

THE DOOR LEAF IS ALSO AVAILABLE IN A REBATED OPTION WITH A SHARP EDGE AND A NON-REBATED OPTION—INFO. P. 92, 104

DECORS





CONSTRUCTION

- 1** the frame is made of an MDF board
- 2** (STANDARD) "honeycomb" filling
- 3** (OPTIONAL) tubular chipboard filling
- 4** frame with filling is covered with HDF boards on both sides
- 5** door leaf covered with ENDURO foil, ECO-VENEER or LAMINOLACK (Norma Decor 1)
 - side edges and upper edge are foiled
 - rounded vertical edges of door leaves (more info on p. 122)
 - double door leaves have a rebate and a counter-rebate (drawing on p. 122)
 - width of single doors: "60"–"100" / width of double doors: "120"–"200"

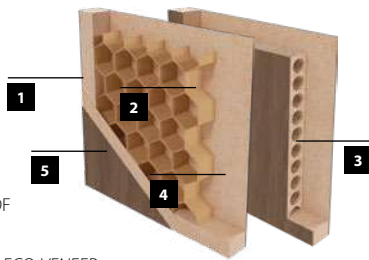

ADDITIONAL OPTIONS

- door without a keyhole no extra charge
- door width "100"
- additional hinge for the door in sizes "60"–"80"
- caps for hinges (chrome, satin chrome, golden, black)—set for 1 hinge unit
- ventilation undercut
- PVC ventilation sleeves
- metal ventilation sleeves, round (chrome, golden)
- metal ventilation sleeves, square (chrome, nickel)
- door made in a non-rebated version for sliding systems
- double door
- cylinder lock insert 31/36
- tubular chipboard filling
- automatic bottom door seal, widths "60"–"90"
- automatic bottom door seal, widths "100"
- aluminium threshold, widths "60"–"90"
- aluminium threshold, widths "100"
- ventilation grid

Additional information: equipment and accessories

P. 133–137

STANDARD EQUIPMENT

- lock 72 mm for a standard key, a WC knob, or a cylinder lock insert
- screw-in pivot hinges 13.5/9 (white zinc)—2 pcs for door leaves in sizes "60"–"80", 3 pcs for door leaves in sizes "90" and "100"

DEDICATED DOOR FRAMES

- [OB3] block door frame (possibility to add an architrave 10 x 60 mm or 16 x 80 mm) P. 125
- [ORS1] adjustable door frame for rebated doors with a flat angle architrave 60 mm-wide P. 126
- [ORS8] adjustable door frame for rebated doors with a flat angle architrave 80 mm-wide P. 126
- NOTE: THE OFFER ALSO INCLUDES METAL DOOR FRAMES P. 128–129

GLASS

the glossy side of glass is on the hinge side



PORHOLE in NORMA DECOR 6: available in silver and black colour with the possibility of using a transparent or satin glass pane (option included in the price of the door leaf)

Rebated Torino 4 in B134



www.invado.pl



WATCH THE ASSEMBLY VIDEOS ON OUR YOUTUBE CHANNEL

DOOR LEAVES OPTIONS

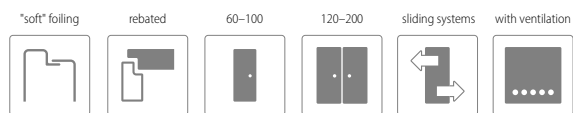

DECORS

ENDURO **



ENDURO 3D **



HORIZONTAL GRAINING

ENDURO PLUS **



ECO-VENEER FORTE ***



ECO-VENEER CPL ***



LAMINOLACK ****



DOOR FRAME COLOUR



CONSTRUCTION

- 1** the frame is made of an MDF board
- 2** (STANDARD) "honeycomb" filling
- 3** (OPTIONAL) tubular chipboard filling
- 4** frame with filling is covered with HDF boards on both sides
- 5** door leaf covered with ENDURO foil or ECO-VENEER
 - side edges and upper edge are foiled
 - rounded vertical edges of door leaves (more info on p. 122)
 - double door leaves have a rebate and a counter-rebate (drawing on p. 122)
 - width of single doors: "60"-"100" / width of double doors: "120"-"200"

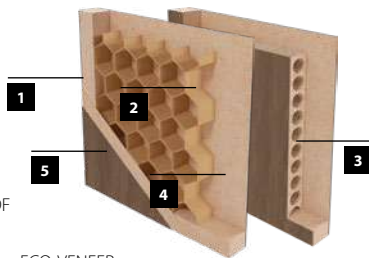

ADDITIONAL OPTIONS

- door without a keyhole no extra charge
- door width "100"
- additional hinge for the door in sizes "60"-"80"
- caps for hinges (chrome, satin chrome, golden, black)—set for 1 hinge unit
- ventilation undercut
- PVC ventilation sleeves
- metal ventilation sleeves, round (chrome, golden)
- metal ventilation sleeves, square (chrome, nickel)
- door made in a non-rebated version for sliding systems
- double door
- cylinder lock insert 31/36
- tubular chipboard filling
- automatic bottom door seal, widths "60"-"100"
- aluminium threshold, widths "60"-"100"

Additional information: equipment and accessories

P. 133-137

STANDARD EQUIPMENT

- lock 72 mm for a standard key, a WC knob, or a cylinder lock insert
- screw-in pivot hinges 13.5/9 (white zinc)—2 pcs for door leaves in sizes "60"-"80", 3 pcs for door leaves in sizes "90" and "100"

DEDICATED DOOR FRAMES

- [OB3] block door frame (possibility to add an architrave 10 x 60 mm or 16 x 80 mm) P. 125
- [ORS1] adjustable door frame for rebated doors with a flat angle architrave 60 mm-wide P. 126
- [ORS8] adjustable door frame for rebated doors with a flat angle architrave 80 mm-wide P. 126
- NOTE: THE OFFER ALSO INCLUDES METAL DOOR FRAMES P. 128-129

GLASS

the glossy side of glass is on the hinge side



Rebated Merano 3 in B339



www.invadopl



WATCH THE ASSEMBLY VIDEOS ON OUR YOUTUBE CHANNEL

DOOR LEAVES OPTIONS

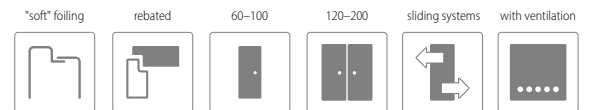

THE DOOR LEAF IS ALSO AVAILABLE IN A REBATED OPTION WITH A SHARP EDGE AND A NON-REBATED OPTION—INFO. P. 102

DECORS

ENDURO **



ENDURO 3D **



HORIZONTAL GRAINING

ENDURO PLUS **



ECO-VENEER FORTE ***



ECO-VENEER CPL ***



LAMINOLACK ****

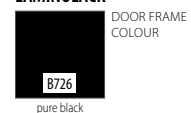

DOOR FRAME COLOUR

Merano 1



Merano 2



Merano 3



Merano 4



Merano 5



CONSTRUCTION

- 1** the frame is made of an MDF board
- 2** (STANDARD) "honeycomb" filling
- 3** (OPTIONAL) tubular chipboard filling
- 4** frame with filling is covered with HDF boards on both sides
- 5** door leaf covered with ENDURO foil or ECO-VENEER
 - side edges and upper edge are foiled
 - rounded vertical edges of door leaves (more info on p. 122)
 - double door leaves have a rebate and a counter-rebate (drawing on p. 122)
 - width of single doors: "60"-"100" / width of double doors: "120"-"200"

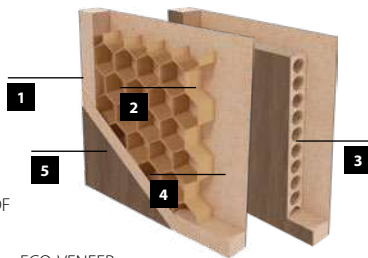

ADDITIONAL OPTIONS

- door without a keyhole no extra charge
- door width "100"
- additional hinge for the door in sizes "60"-"80"
- caps for hinges (chrome, satin chrome, golden, black)—set for 1 hinge unit
- ventilation undercut
- PVC ventilation sleeves
- metal ventilation sleeves, round (chrome, golden)
- metal ventilation sleeves, square (chrome, nickel)
- door made in a non-rebated version for sliding systems
- double door
- cylinder lock insert 31/36
- tubular chipboard filling
- automatic bottom door seal, widths "60"-"100"
- aluminium threshold, widths "60"-"100"

Additional information: equipment and accessories

P. 133-137

STANDARD EQUIPMENT

- lock 72 mm for a standard key, a WC knob, or a cylinder lock insert
- screw-in pivot hinges 13.5/9 (white zinc)—2 pcs for door leaves in sizes "60"-"80", 3 pcs for door leaves in sizes "90" and "100"

DEDICATED DOOR FRAMES

- [OB3] block door frame (possibility to add an architrave 10 x 60 mm or 16 x 80 mm) P. 125
- [ORS1] adjustable door frame for rebated doors with a flat angle architrave 60 mm-wide P. 126
- [ORS8] adjustable door frame for rebated doors with a flat angle architrave 80 mm-wide P. 126
- NOTE: THE OFFER ALSO INCLUDES METAL DOOR FRAMES P. 128-129

GLASS

the glossy side of glass is on the hinge side



no extra charge

no extra charge

Rebated Lido 14 in B134



www.invado.pl



WATCH THE ASSEMBLY VIDEOS ON OUR YOUTUBE CHANNEL

DOOR LEAVES OPTIONS

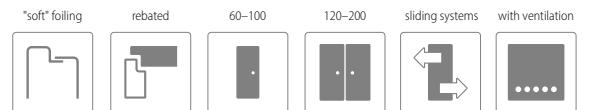

THE DOOR LEAF IS ALSO AVAILABLE IN A REBATED OPTION WITH A SHARP EDGE AND A NON-REBATED OPTION—INFO. P. 94, 106

DECORS

ENDURO **



ENDURO 3D **



HORIZONTAL GRAINING

ENDURO PLUS **



ECO-VENEER FORTE ***



ECO-VENEER CPL ***



LAMINOLACK ****



DOOR FRAME COLOUR



CONSTRUCTION

- 1** the frame is made of an MDF board
- 2** (STANDARD) tubular chipboard filling
- 3** frame with filling is covered with HDF boards on both sides
- 4** door leaf covered with ENDURO foil or ECO-VENEER
 - ALU strip—8 mm
 - side edges and upper edge are foiled
 - rounded vertical edges of door leaves (more info on p. 122)
 - double door leaves have a rebate and a counter-rebate (drawing on p. 122)
 - width of single doors: "60"–"100" / width of double doors: "120"–"200"

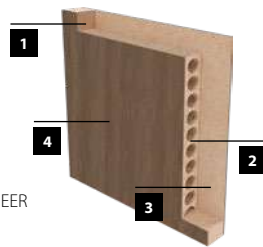

ADDITIONAL OPTIONS

- door without a keyhole no extra charge
- door width "100"
- additional hinge for the door in sizes "60"–"80"
- caps for hinges (chrome, satin chrome, golden, black)—set for 1 hinge unit
- ventilation undercut
- PVC ventilation sleeves
- metal ventilation sleeves, round (chrome, golden)
- metal ventilation sleeves, square (chrome, nickel)
- door made in a non-rebated version for sliding systems
- double door
- cylinder lock insert 31/36
- tubular chipboard filling standard
- automatic bottom door seal, widths "60"–"100"
- aluminium threshold, widths "60"–"100"

Additional information: equipment and accessories

P. 133–137

STANDARD EQUIPMENT

- lock 72 mm for a standard key, a WC knob, or a cylinder lock insert
- screw-in pivot hinges 13.5/9 (white zinc)—2 pcs for door leaves in sizes "60"–"80", 3 pcs for door leaves in sizes "90" and "100"

DEDICATED DOOR FRAMES

- [OB3] block door frame (possibility to add an architrave 10 x 60 mm or 16 x 80 mm) P. 125
- [ORS1] adjustable door frame for rebated doors with a flat angle architrave 60 mm-wide P. 126
- [ORS8] adjustable door frame for rebated doors with a flat angle architrave 80 mm-wide P. 126
- NOTE: THE OFFER ALSO INCLUDES METAL DOOR FRAMES P. 128–129

Rebated Dolce 1 in B224



www.invado.pl



WATCH THE ASSEMBLY VIDEOS ON OUR YOUTUBE CHANNEL

DOOR LEAVES OPTIONS

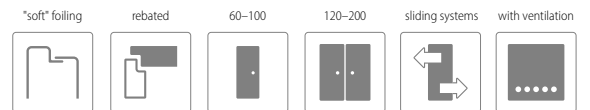

THE DOOR LEAF IS ALSO AVAILABLE IN A REBATED OPTION WITH A SHARP EDGE AND A NON-REBATED OPTION—INFO. P. 96

DECORS

ENDURO **



ENDURO 3D **

ENDURO PLUS **



ECO-VENEER FORTE ***



ECO-VENEER CPL ***



LAMINOLACK ****



DOOR FRAME COLOUR

Dolce 1



Dolce 2



Dolce 3



CONSTRUCTION

- 1** the frame is made of an MDF board
- 2** (STANDARD) "honeycomb" filling
- 3** (OPTIONAL) tubular chipboard filling
- 4** frame with filling is covered with HDF boards on both sides
- 5** door leaf covered with ENDURO foil or ECO-VENEER
 - side edges and upper edge are foiled
 - rounded vertical edges of door leaves (more info on p. 122)
 - double door leaves have a rebate and a counter-rebate (drawing on p. 122)
 - width of single doors: "60"–"100" / width of double doors: "120"–"200"

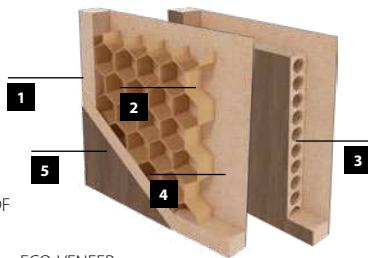

ADDITIONAL OPTIONS

- door without a keyhole no extra charge
- door width "100"
- additional hinge for the door in sizes "60"–"80"
- caps for hinges (chrome, satin chrome, golden, black)—set for 1 hinge unit
- ventilation undercut
- PVC ventilation sleeves
- metal ventilation sleeves, round (chrome, golden)
- metal ventilation sleeves, square (chrome, nickel)
- door made in a non-rebated version for sliding systems
- double door
- cylinder lock insert 31/36
- tubular chipboard filling
- automatic bottom door seal, widths "60"–"100"
- aluminium threshold, widths "60"–"100"

Additional information: equipment and accessories

P. 133–137

STANDARD EQUIPMENT

- lock 72 mm for a standard key, a WC knob, or a cylinder lock insert
- screw-in pivot hinges 13.5/9 (white zinc)—2 pcs for door leaves in sizes "60"–"80", 3 pcs for door leaves in sizes "90" and "100"

DEDICATED DOOR FRAMES

- [OB3] block door frame (possibility to add an architrave 10 x 60 mm or 16 x 80 mm) P. 125
- [ORS1] adjustable door frame for rebated doors with a flat angle architrave 60 mm-wide P. 126
- [ORS8] adjustable door frame for rebated doors with a flat angle architrave 80 mm-wide P. 126
- NOTE: THE OFFER ALSO INCLUDES METAL DOOR FRAMES P. 128–129

GLASS

the glossy side of glass is on the hinge side



Rebated Strada 2 in B490



www.invado.pl



WATCH THE ASSEMBLY VIDEOS ON OUR YOUTUBE CHANNEL

DOOR LEAVES OPTIONS

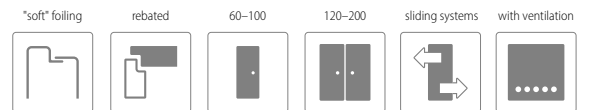

DECORS

ENDURO **

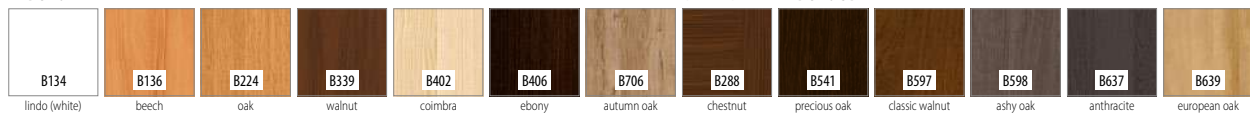

ENDURO PLUS **



ECO-VENEER FORTE ***



ECO-VENEER CPL ***



LAMINOLACK ****



DOOR FRAME COLOUR

Strada 1



Strada 2



Strada 3



CONSTRUCTION

- 1** the frame is made of an MDF board
- 2** (STANDARD) "honeycomb" filling
- 3** (OPTIONAL) tubular chipboard filling
- 4** frame with filling is covered with HDF boards on both sides
- 5** door leaf covered with ENDURO foil or ECO-VENEER
 - side edges and upper edge are foiled
 - rounded vertical edges of door leaves (more info on p. 122)
 - double door leaves have a rebate and a counter-rebate (drawing on p. 122)
 - width of single doors: "60"–"100" / width of double doors: "120"–"200"

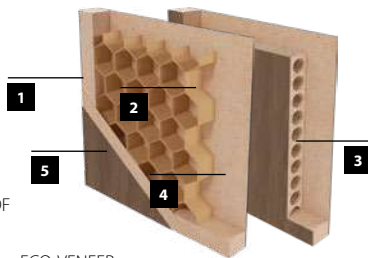

ADDITIONAL OPTIONS

- door without a keyhole no extra charge
- door width "100"
- additional hinge for the door in sizes "60"–"80"
- caps for hinges (chrome, satin chrome, golden, black)—set for 1 hinge unit
- ventilation undercut
- PVC ventilation sleeves
- metal ventilation sleeves, round (chrome, golden)
- metal ventilation sleeves, square (chrome, nickel)
- door made in a non-rebated version for sliding systems
- double door
- cylinder lock insert 31/36
- tubular chipboard filling
- automatic bottom door seal, widths "60"–"100"
- aluminium threshold, widths "60"–"100"

Additional information: equipment and accessories

P. 133–137

STANDARD EQUIPMENT

- lock 72 mm for a standard key, a WC knob, or a cylinder lock insert
- screw-in pivot hinges 13.5/9 (white zinc)—2 pcs for door leaves in sizes "60"–"80", 3 pcs for door leaves in sizes "90" and "100"

DEDICATED DOOR FRAMES

- [OB3] block door frame (possibility to add an architrave 10 x 60 mm or 16 x 80 mm) P. 125
- [ORS1] adjustable door frame for rebated doors with a flat angle architrave 60 mm-wide P. 126
- [ORS8] adjustable door frame for rebated doors with a flat angle architrave 80 mm-wide P. 126
- NOTE: THE OFFER ALSO INCLUDES METAL DOOR FRAMES P. 128–129

GLASS

the glossy side of glass is on the hinge side



Rebated Sagittarius 2 in B490



www.invado.pl



WATCH THE ASSEMBLY VIDEOS ON OUR YOUTUBE CHANNEL

DOOR LEAVES OPTIONS

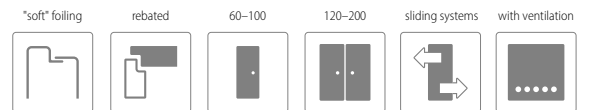

DECORS

ENDURO **

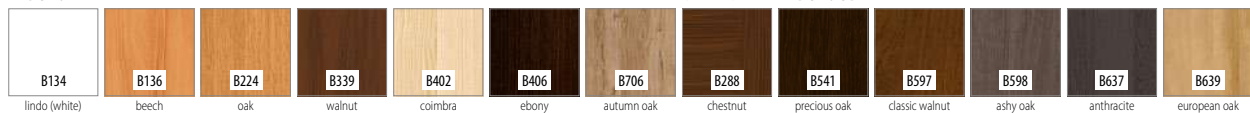

ENDURO PLUS **



ECO-VENEER FORTE ***



ECO-VENEER CPL ***



LAMINOLACK ****



DOOR FRAME COLOUR

Sagittarius 1



Sagittarius 2



Sagittarius 3



CONSTRUCTION

- 1** the frame is made of an MDF board
- 2** (STANDARD) "honeycomb" filling
- 3** (OPTIONAL) tubular chipboard filling
- 4** frame with filling is covered with HDF boards on both sides
- 5** door leaf covered with ENDURO foil or ECO-VENEER
 - side edges and upper edge are foiled
 - rounded vertical edges of door leaves (more info on p. 122)
 - double door leaves have a rebate and a counter-rebate (drawing on p. 122)
 - width of single doors: "60"–"100" / width of double doors: "120"–"200"

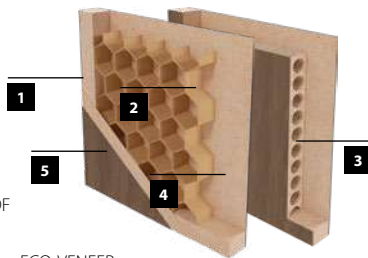

ADDITIONAL OPTIONS

- door without a keyhole no extra charge
- door width "100"
- additional hinge for the door in sizes "60"–"80"
- caps for hinges (chrome, satin chrome, golden, black)—set for 1 hinge unit
- ventilation undercut
- PVC ventilation sleeves
- metal ventilation sleeves, round (chrome, golden)
- metal ventilation sleeves, square (chrome, nickel)
- door made in a non-rebated version for sliding systems
- double door
- cylinder lock insert 31/36
- tubular chipboard filling
- automatic bottom door seal, widths "60"–"100"
- aluminium threshold, widths "60"–"100"

Additional information: equipment and accessories

P. 133–137

STANDARD EQUIPMENT

- lock 72 mm for a standard key, a WC knob, or a cylinder lock insert
- screw-in pivot hinges 13.5/9 (white zinc)—2 pcs for door leaves in sizes "60"–"80", 3 pcs for door leaves in sizes "90" and "100"

DEDICATED DOOR FRAMES

- [OB3] block door frame (possibility to add an architrave 10 x 60 mm or 16 x 80 mm) P. 125
- [ORS1] adjustable door frame for rebated doors with a flat angle architrave 60 mm-wide P. 126
- [ORS8] adjustable door frame for rebated doors with a flat angle architrave 80 mm-wide P. 126
- NOTE: THE OFFER ALSO INCLUDES METAL DOOR FRAMES P. 128-129

GLASS

the glossy side of glass is on the hinge side



no extra charge

Rebated Gemini 1 in B402



WATCH THE ASSEMBLY VIDEOS ON OUR YOUTUBE CHANNEL

DOOR LEAVES OPTIONS

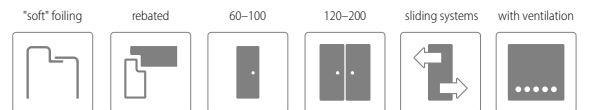

DECORS

ENDURO **					2-WAY GRAINING		ENDURO 3D **					- HORIZONTAL GRAINING -		
ENDURO PLUS **					ECO-VENEER FORTE ***					ECO-VENEER CPL ***		LAMINOLACK ****		
												DOOR FRAME COLOUR		

Gemini 1



Gemini 2



Gemini 3



CONSTRUCTION

- 1** the frame is made of an MDF board
- 2** (STANDARD) "honeycomb" filling
- 3** (OPTIONAL) tubular chipboard filling
- 4** frame with filling is covered with HDF boards on both sides
- 5** door leaf covered with ENDURO foil or ECO-VENEER
 - side edges and upper edge are foiled
 - rounded vertical edges of door leaves (more info on p. 122)
 - double door leaves have a rebate and a counter-rebate (drawing on p. 122)
 - width of single doors: "60"–"100" / width of double doors: "120"–"200"

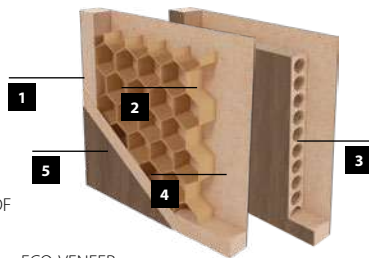

ADDITIONAL OPTIONS

- door without a keyhole no extra charge
- door width "100"
- additional hinge for the door in sizes "60"–"80"
- caps for hinges (chrome, satin chrome, golden, black)—set for 1 hinge unit
- ventilation undercut
- PVC ventilation sleeves
- metal ventilation sleeves, round (chrome, golden)
- metal ventilation sleeves, square (chrome, nickel)
- door made in a non-rebated version for sliding systems
- double door
- cylinder lock insert 31/36
- tubular chipboard filling
- automatic bottom door seal, widths "60"–"100"
- aluminium threshold, widths "60"–"100"

Additional information: equipment and accessories

P. 133–137

STANDARD EQUIPMENT

- lock 72 mm for a standard key, a WC knob, or a cylinder lock insert
- screw-in pivot hinges 13.5/9 (white zinc)—2 pcs for door leaves in sizes "60"–"80", 3 pcs for door leaves in sizes "90" and "100"

DEDICATED DOOR FRAMES

- [OB3] block door frame (possibility to add an architrave 10 x 60 mm or 16 x 80 mm) P. 125
- [ORS1] adjustable door frame for rebated doors with a flat angle architrave 60 mm-wide P. 126
- [ORS8] adjustable door frame for rebated doors with a flat angle architrave 80 mm-wide P. 126
- NOTE: THE OFFER ALSO INCLUDES METAL DOOR FRAMES P. 128–129

GLASS

the glossy side of glass is on the hinge side



no extra charge

Rebated Virgo 1 in B639



WATCH THE ASSEMBLY VIDEOS ON OUR YOUTUBE CHANNEL

DOOR LEAVES OPTIONS

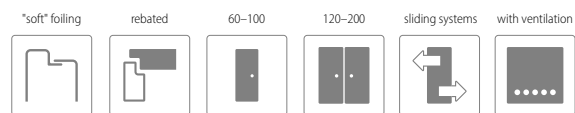

THE DOOR LEAF IS ALSO AVAILABLE IN A REBATED OPTION WITH A SHARP EDGE AND A NON-REBATED OPTION—INFO. P. 98

DECORS

ENDURO **						2-WAY GRAINING						ENDURO 3D **				- HORIZONTAL GRAINING -			
B134	B136	B224	B339	B402	B406	B706	B288	B541	B597	B598	B637	B639	B656	B657					
lindo (white)	beech	oak	walnut	coimbra	ebony	autumn oak	chestnut	precious oak	classic walnut	ashy oak	anthracite	european oak	italian oak	severo oak					
ENDURO PLUS **						ECO-VENEER FORTE ***				ECO-VENEER CPL ***				LAMINOLACK ****					
B462	B587	B596	B705	B707	B708	B473	B474	B476	B490					B726					
cedar forte	naturo oak	snowy oak	spring oak	winter oak	siberian larch	duro walnut	eterno oak	grey oak	white					pure black					

Virgo 1



Virgo 2



Virgo 3



CONSTRUCTION

- 1** the frame is made of an MDF board
- 2** (STANDARD) "honeycomb" filling
- 3** (OPTIONAL) tubular chipboard filling
- 4** frame with filling is covered with HDF boards on both sides
- 5** door leaf covered with ENDURO foil or ECO-VENEER
 - side edges and upper edge are foiled
 - rounded vertical edges of door leaves (more info on p. 122)
 - double door leaves have a rebate and a counter-rebate (drawing on p. 122)
 - width of single doors: "60"-"100" / width of double doors: "120"-"200"

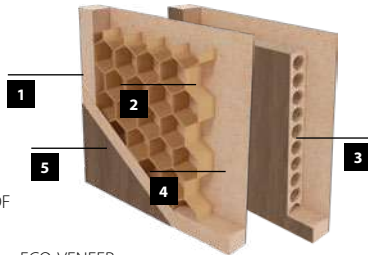

ADDITIONAL OPTIONS

- door without a keyhole no extra charge
- door width "100"
- additional hinge for the door in sizes "60"-"80"
- caps for hinges (chrome, satin chrome, golden, black)—set for 1 hinge unit
- ventilation undercut
- PVC ventilation sleeves
- metal ventilation sleeves, round (chrome, golden)
- metal ventilation sleeves, square (chrome, nickel)
- door made in a non-rebated version for sliding systems
- double door
- cylinder lock insert 31/36
- tubular chipboard filling
- automatic bottom door seal, widths "60"-"100"
- aluminium threshold, widths "60"-"100"

Additional information: equipment and accessories

P. 133-137

STANDARD EQUIPMENT

- lock 72 mm for a standard key, a WC knob, or a cylinder lock insert
- screw-in pivot hinges 13.5/9 (white zinc)—2 pcs for door leaves in sizes "60"-"80", 3 pcs for door leaves in sizes "90" and "100"

DEDICATED DOOR FRAMES

- [OB3] block door frame (possibility to add an architrave 10 x 60 mm or 16 x 80 mm) P. 125
- [ORS1] adjustable door frame for rebated doors with a flat angle architrave 60 mm-wide P. 126
- [ORS8] adjustable door frame for rebated doors with a flat angle architrave 80 mm-wide P. 126
- NOTE: THE OFFER ALSO INCLUDES METAL DOOR FRAMES P. 128-129

GLASS

the glossy side of glass is on the hinge side



no extra charge



Rebated Parma 2 in B707
Door frame in B726



WATCH THE ASSEMBLY VIDEOS ON OUR YOUTUBE CHANNEL

DOOR LEAVES OPTIONS

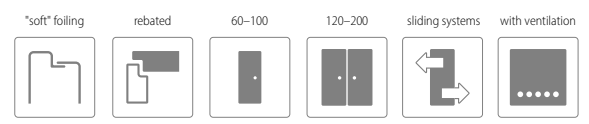

DECORS

ENDURO **						2-WAY GRAINING						ENDURO 3D **			- HORIZONTAL GRAINING -		
ENDURO PLUS **	ECO-VENEER FORTE ***						ECO-VENEER CPL ***			LAMINOLACK ****			DOOR FRAME COLOUR				

Parma 1



Parma 2



Parma 3



CONSTRUCTION

- 1** the frame is made of an MDF board
- 2** (STANDARD) "honeycomb" filling
- 3** (OPTIONAL) tubular chipboard filling
- 4** frame with filling is covered with HDF boards on both sides
- 5** door leaf covered with ENDURO foil or ECO-VENEER
 - side edges and upper edge are foiled
 - rounded vertical edges of door leaves (more info on p. 122)
 - double door leaves have a rebate and a counter-rebate (drawing on p. 122)
 - width of single doors: "60"-"100" / width of double doors: "120"-"200"

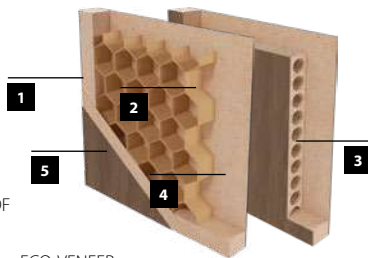

ADDITIONAL OPTIONS

- door without a keyhole no extra charge
- door width "100"
- additional hinge for the door in sizes "60"-"80"
- caps for hinges (chrome, satin chrome, golden, black)—set for 1 hinge unit
- ventilation undercut
- PVC ventilation sleeves
- metal ventilation sleeves, round (chrome, golden)
- metal ventilation sleeves, square (chrome, nickel)
- door made in a non-rebated version for sliding systems
- double door
- cylinder lock insert 31/36
- tubular chipboard filling
- automatic bottom door seal, widths "60"-"100"
- aluminium threshold, widths "60"-"100"

Additional information: equipment and accessories

P. 133-137

STANDARD EQUIPMENT

- lock 72 mm for a standard key, a WC knob, or a cylinder lock insert
- screw-in pivot hinges 13.5/9 (white zinc)—2 pcs for door leaves in sizes "60"-"80", 3 pcs for door leaves in sizes "90" and "100"

DEDICATED DOOR FRAMES

- [OB3] block door frame (possibility to add an architrave 10 x 60 mm or 16 x 80 mm) P. 125
- [ORS1] adjustable door frame for rebated doors with a flat angle architrave 60 mm-wide P. 126
- [ORS8] adjustable door frame for rebated doors with a flat angle architrave 80 mm-wide P. 126
- NOTE: THE OFFER ALSO INCLUDES METAL DOOR FRAMES P. 128-129

GLASS

the glossy side of glass is on the hinge side





Rebated Orso 3 in B541

www.invadopl



WATCH THE ASSEMBLY VIDEOS ON OUR YOUTUBE CHANNEL

DOOR LEAVES OPTIONS

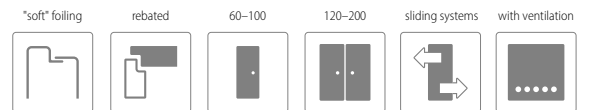

THE DOOR LEAF IS ALSO AVAILABLE IN A REBATED OPTION WITH A SHARP EDGE AND A NON-REBATED OPTION—INFO. P. 100

DECORS

ENDURO ••						2-WAY GRAINING						ENDURO 3D ••				- HORIZONTAL GRAINING -			
<small>B134 lindo (white)</small>	<small>B136 beech</small>	<small>B224 oak</small>	<small>B339 walnut</small>	<small>B402 coimbra</small>	<small>B406 ebony</small>	<small>B706 autumn oak</small>	<small>B288 chestnut</small>	<small>B541 precious oak</small>	<small>B597 classic walnut</small>	<small>B598 ashy oak</small>	<small>B637 anthracite</small>	<small>B639 european oak</small>	<small>B656 italian oak</small>	<small>B657 severo oak</small>					
ENDURO PLUS ••						ECO-VENEER FORTE •••				ECO-VENEER CPL •••				LAMINOLACK ••••					
<small>B462 cedar forte</small>	<small>B587 naturo oak</small>	<small>B596 snowy oak</small>	<small>B705 spring oak</small>	<small>B707 winter oak</small>	<small>B708 siberian larch</small>	<small>B473 duro walnut</small>	<small>B474 eterno oak</small>	<small>B476 grey oak</small>	<small>B490 white</small>					<small>B726 pure black</small>	<small>DOOR FRAME COLOUR</small>				



CONSTRUCTION

- 1** the frame is made of an MDF board
- 2** (STANDARD) "honeycomb" filling
- 3** (OPTIONAL) tubular chipboard filling
- 4** frame with filling is covered with HDF boards on both sides
- 5** door leaf covered with ENDURO foil or ECO-VENEER
 - side edges and upper edge are foiled
 - rounded vertical edges of door leaves (more info on p. 122)
 - double door leaves have a rebate and a counter-rebate (drawing on p. 122)
 - width of single doors: "60"-"100" / width of double doors: "120"-"200"

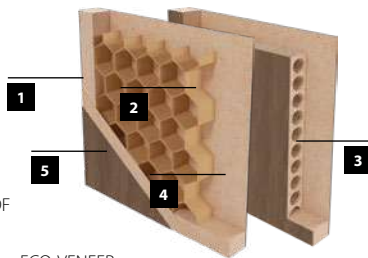

ADDITIONAL OPTIONS

- door without a keyhole no extra charge
- door width "100"
- additional hinge for the door in sizes "60"-"80"
- caps for hinges (chrome, satin chrome, golden, black)—set for 1 hinge unit
- ventilation undercut
- PVC ventilation sleeves
- metal ventilation sleeves, round (chrome, golden)
- metal ventilation sleeves, square (chrome, nickel)
- door made in a non-rebated version for sliding systems
- double door
- cylinder lock insert 31/36
- tubular chipboard filling
- automatic bottom door seal, widths "60"-"100"
- aluminium threshold, widths "60"-"100"

Additional information: equipment and accessories

P. 133-137

STANDARD EQUIPMENT

- lock 72 mm for a standard key, a WC knob, or a cylinder lock insert
- screw-in pivot hinges 13.5/9 (white zinc)—2 pcs for door leaves in sizes "60"-"80", 3 pcs for door leaves in sizes "90" and "100"

DEDICATED DOOR FRAMES

- [OB3] block door frame (possibility to add an architrave 10 x 60 mm or 16 x 80 mm) P. 125
- [ORS1] adjustable door frame for rebated doors with a flat angle architrave 60 mm-wide P. 126
- [ORS8] adjustable door frame for rebated doors with a flat angle architrave 80 mm-wide P. 126
- NOTE: THE OFFER ALSO INCLUDES METAL DOOR FRAMES P. 128-129

GLASS

the glossy side of glass is on the hinge side



Rebated Libra in B637



www.invado.pl



WATCH THE ASSEMBLY VIDEOS ON OUR YOUTUBE CHANNEL

DOOR LEAVES OPTIONS

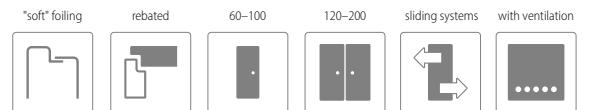

DECORS

ENDURO **						2-WAY GRAINING						ENDURO 3D **				- HORIZONTAL GRAINING -									
lindo (white)	beech	oak	walnut	coimbra	ebony	autumn oak	chestnut	precious oak	classic walnut	ashy oak	anthracite	european oak	italian oak	severo oak	cedar forte	natur oak	snowy oak	spring oak	winter oak	siberian larch	duro walnut	eterno oak	grey oak	white	pure black
ENDURO PLUS **						ECO-VENEER FORTE ***						ECO-VENEER CPL ***				LAMINOLACK ****									
																DOOR FRAME COLOUR									



Libra



Taurus

TAURUS DOOR LEAVES ARE AVAILABLE ONLY IN CHESTNUT B288

CONSTRUCTION

- 1** the frame is made of an MDF board
- 2** (STANDARD) "honeycomb" filling
- 3** (OPTIONAL) tubular chipboard filling
- 4** frame with filling is covered with HDF boards on both sides
- 5** door leaf covered with ENDURO foil or ECO-VENEER
 - side edges and upper edge are foiled
 - rounded vertical edges of door leaves (more info on p. 122)
 - double door leaves have a rebate and a counter-rebate (drawing on p. 122)
 - width of single doors: "60"-"100" / width of double doors: "120"-"200"

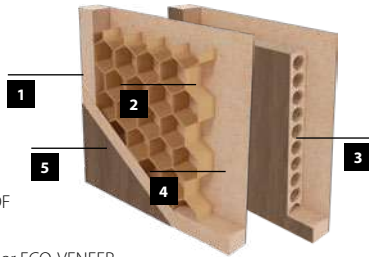

ADDITIONAL OPTIONS

- door without a keyhole no extra charge
- door width "100"
- additional hinge for the door in sizes "60"-"80"
- caps for hinges (chrome, satin chrome, golden, black)—set for 1 hinge unit
- ventilation undercut
- PVC ventilation sleeves
- metal ventilation sleeves, round (chrome, golden)
- metal ventilation sleeves, square (chrome, nickel)
- door made in a non-rebated version for sliding systems
- double door
- cylinder lock insert 31/36
- tubular chipboard filling
- automatic bottom door seal, widths "60"-"100"
- aluminium threshold, widths "60"-"100"

Additional information: equipment and accessories

P. 133-137

STANDARD EQUIPMENT

- lock 72 mm for a standard key, a WC knob, or a cylinder lock insert
- screw-in pivot hinges 13.5/9 (white zinc)—2 pcs for door leaves in sizes "60"-"80", 3 pcs for door leaves in sizes "90" and "100"

DEDICATED DOOR FRAMES

- [OB3] block door frame (possibility to add an architrave 10 x 60 mm or 16 x 80 mm) P. 125
- [ORS1] adjustable door frame for rebated doors with a flat angle architrave 60 mm-wide P. 126
- [ORS8] adjustable door frame for rebated doors with a flat angle architrave 80 mm-wide P. 126
- NOTE: THE OFFER ALSO INCLUDES METAL DOOR FRAMES P. 128-129

GLASS

the glossy side of glass is on the hinge side



MODERN AND OPTIMO

LINE

To meet the needs of the market and our most demanding customers, we present six collections of door leaves made in the technology of sharp edge veneering (90°)—**CUT EDGE**.

The **MODERN LINE** collection is available in selected, solid veneers from the standard offer, thanks to which the door can be matched to the interior dedicated to it.

OPTIMO LINE, in addition to the new, unique colours, also offers the possibility of using the edge of the door leaf in a different colour.





New

Belgatto

MODERN LINE COLLECTION

Non-rebated Belgatto 9 in B706
Door frame in B726



www.inवादo.pl



WATCH THE ASSEMBLY VIDEOS ON OUR YOUTUBE CHANNEL

DOOR LEAVES OPTIONS

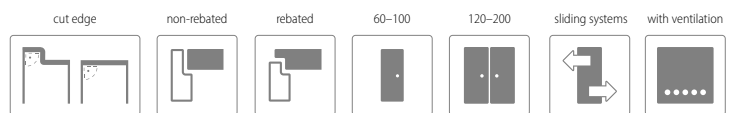

DECORS

ENDURO ..



B134

lindo (white)



B706

autumn oak

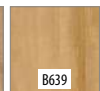

B639

european oak

LAMINOLACK



B726

pure black

DOOR FRAME COLOUR



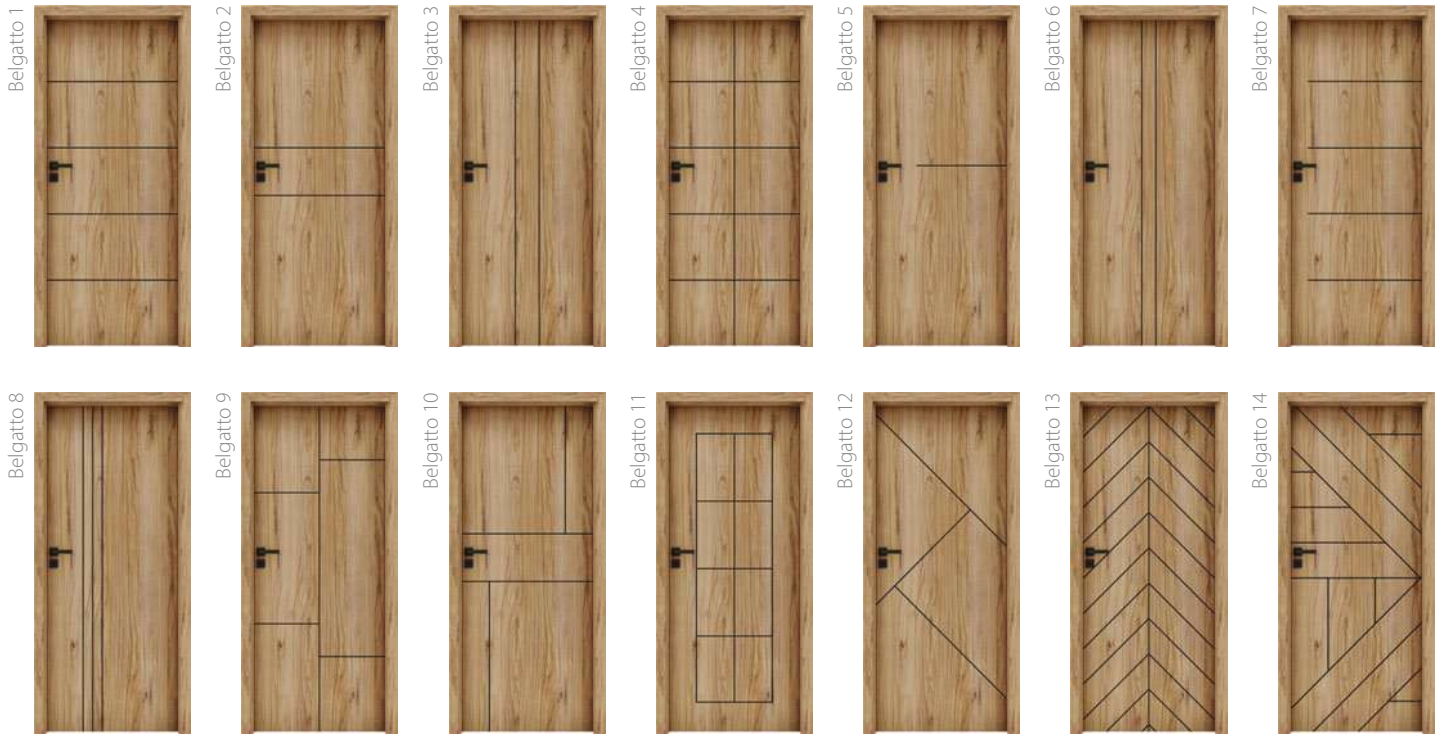

AVAILABLE ONLY AS SINGLE DOORS

CONSTRUCTION

- 1** the frame is made of an MDF board
- 2** (STANDARD) "honeycomb" filling
- 3** (OPTIONAL) tubular chipboard filling
- 4** frame with filling is covered with HDF boards on both sides
- 5** door leaf covered with ENDURO foil
 - side edges and upper edge are foiled
 - edge band in the colour of the door leaf (STANDARD) or pure black (OPTION)
 - cut edges (90°) of door leaf (more info on p. 122)
 - double door leaves have a rebate and a counter-rebate (drawing on p. 122)
 - width of single doors: "60"–"100" / width of double doors: "120"–"200"
 - black milling—"U" with a width of 8 mm

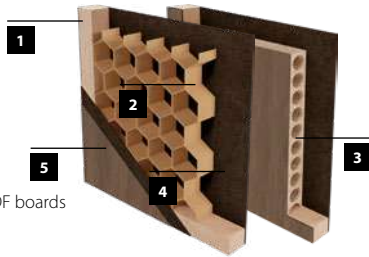

STANDARD EQUIPMENT

- | | |
|-------------|--|
| rebated | <ul style="list-style-type: none"> • lock 72 mm for a standard key, a WC knob, or a cylinder lock insert • screw-in pivot hinges 13.5/9 (white zinc)—2 pcs for door leaves in sizes "60"–"80", 3 pcs for door leaves in sizes "90" and "100" |
| non-rebated | <ul style="list-style-type: none"> • magnetic lock 90 mm for a standard key, 95 mm for a WC knob, and 85 mm for a cylinder lock insert • hidden hinges with a 3D regulation in the colour satin chrome |

DEDICATED DOOR FRAMES

- [OB3] block door frame (possibility to add an architrave 10 x 60 mm or 16 x 80 mm) **P. 125**
- [ORS1] adjustable door frame for rebated doors with a flat angle architrave 60 mm-wide **P. 126**
- [ORS8] adjustable door frame for rebated doors with a flat angle architrave 80 mm-wide **P. 126**
- [ORS7] adjustable door frame for modular non-rebated doors with a flat angle architrave 60 mm-wide **P. 127**
- [ORS10] adjustable door frame for modular non-rebated doors with a flat angle architrave 80 mm-wide **P. 127**
- [ORS4] adjustable 90° door frame for modular non-rebated doors with a flat angle architrave 80 mm-wide **P. 127**
- NOTE: THE OFFER ALSO INCLUDES METAL DOOR FRAMES **P. 128-129**

ADDITIONAL OPTIONS

- door without a keyhole no extra charge
 - door width "100"
 - door made in non-rebated version
 - door made in a non-rebated version for sliding systems
 - double door (selected models)
 - tubular chipboard filling
 - automatic bottom door seal, widths "60"–"100"
 - aluminium threshold, widths: "60"–"100"
- | | |
|-------------|--|
| rebated | <ul style="list-style-type: none"> • cylinder lock insert 31/36 • additional hinge for the door in sizes "60"–"80" • caps for hinges (chrome, satin chrome, golden, black)—set for 1 hinge unit |
| non-rebated | <ul style="list-style-type: none"> • additional hinge—included in a door frame • cylinder lock insert 31/31 |
- reinforcement for self-closer
 - ventilation undercut
 - pure black edge band of the door leaf (rebated and non-rebated)

Additional information: equipment and accessories

P. 133–137

CRAFT-DESIGN

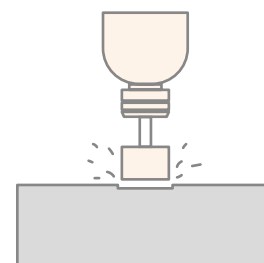

New

Decorato

MODERN LINE COLLECTION

Non-rebated Decorato 13 in B134



www.invadopl



WATCH THE
ASSEMBLY VIDEOS
ON OUR YOUTUBE
CHANNEL

DOOR LEAVES OPTIONS

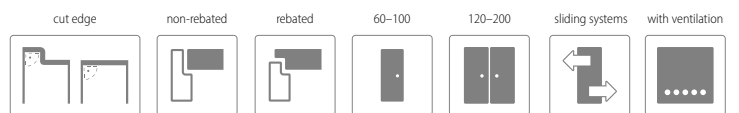

DECORS

ENDURO **



ENDURO 3D **



LAMINOLACK ****



DOOR FRAME
COLOUR

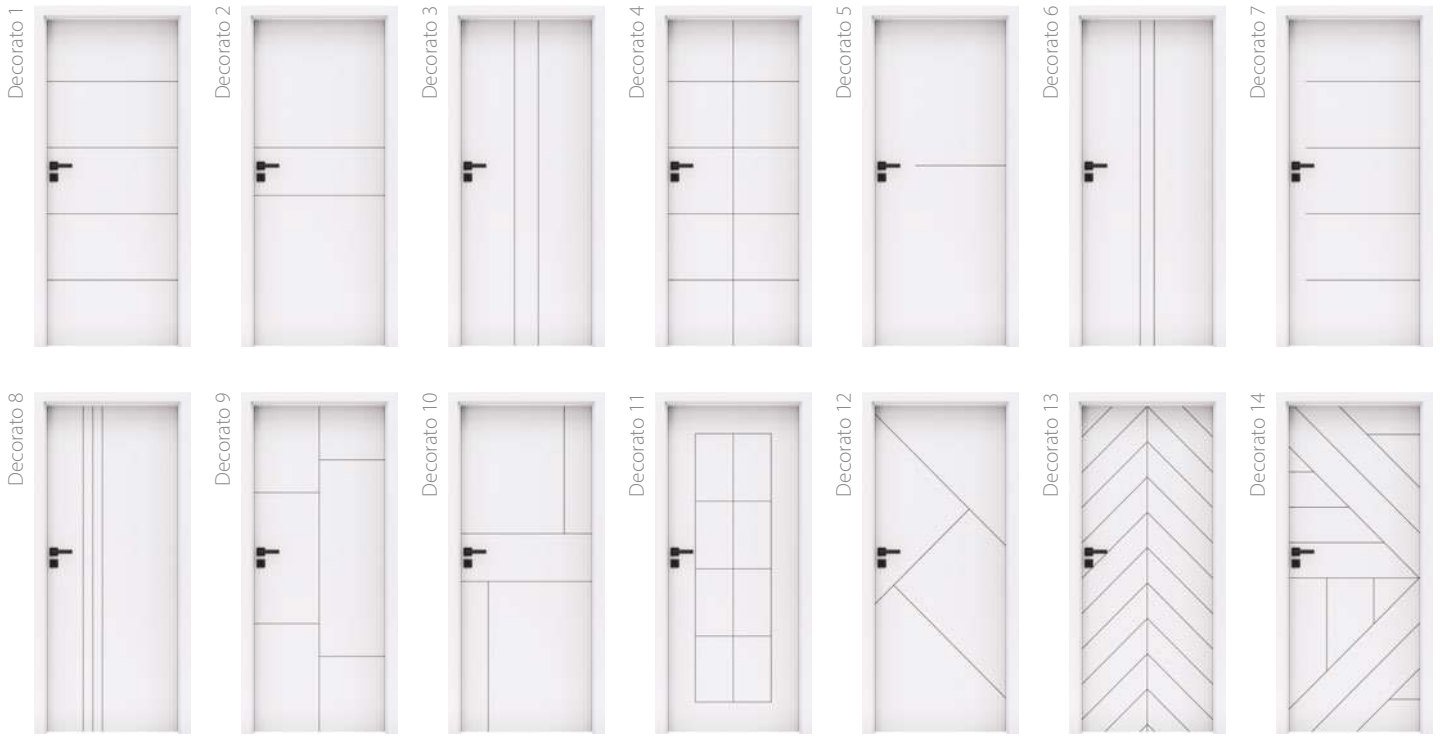

AVAILABLE ONLY AS SINGLE DOORS

CONSTRUCTION

- 1** the frame is made of an MDF board
- 2** (STANDARD) "honeycomb" filling
- 3** (OPTIONAL) tubular chipboard filling
- 4** frame with filling is covered with HDF boards on both sides
- 5** door leaf covered with ENDURO foil
 - side edges and upper edge are foiled
 - edge band in the colour of the door leaf (STANDARD) or pure black (OPTION)
 - cut edges (90°) of door leaf (more info on p. 122)
 - double door leaves have a rebate and a counter-rebate (drawing on p. 122)
 - width of single doors: "60"–"100" / width of double doors: "120"–"200"
 - black milling—"V" with a width of 3 mm

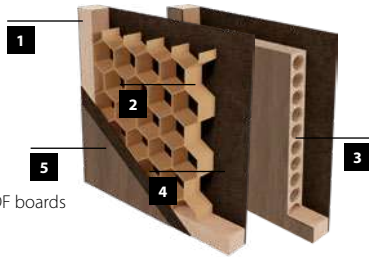

STANDARD EQUIPMENT

- | | |
|-------------|--|
| rebated | <ul style="list-style-type: none"> • lock 72 mm for a standard key, a WC knob, or a cylinder lock insert • screw-in pivot hinges 13.5/9 (white zinc)—2 pcs for door leaves in sizes "60"–"80", 3 pcs for door leaves in sizes "90" and "100" |
| non-rebated | <ul style="list-style-type: none"> • magnetic lock 90 mm for a standard key, 95 mm for a WC knob, and 85 mm for a cylinder lock insert • hidden hinges with a 3D regulation in the colour satin chrome |

DEDICATED DOOR FRAMES

- [OB3] block door frame (possibility to add an architrave 10 x 60 mm or 16 x 80 mm) **P. 125**
- [ORS1] adjustable door frame for rebated doors with a flat angle architrave 60 mm-wide **P. 126**
- [ORS8] adjustable door frame for rebated doors with a flat angle architrave 80 mm-wide **P. 126**
- [ORS7] adjustable door frame for modular non-rebated doors with a flat angle architrave 60 mm-wide **P. 127**
- [ORS10] adjustable door frame for modular non-rebated doors with a flat angle architrave 80 mm-wide **P. 127**
- [ORS4] adjustable 90° door frame for modular non-rebated doors with a flat angle architrave 80 mm-wide **P. 127**
- NOTE: THE OFFER ALSO INCLUDES METAL DOOR FRAMES **P. 128-129**

ADDITIONAL OPTIONS

- door without a keyhole no extra charge
 - door width "100"
 - door made in non-rebated version
 - door made in a non-rebated version for sliding systems
 - double door (selected models)
 - tubular chipboard filling
 - automatic bottom door seal, widths "60"–"100"
 - aluminium threshold, widths: "60"–"100"
- | | |
|-------------|--|
| rebated | <ul style="list-style-type: none"> • cylinder lock insert 31/36 • additional hinge for the door in sizes "60"–"80" • caps for hinges (chrome, satin chrome, golden, black)—set for 1 hinge unit |
| non-rebated | <ul style="list-style-type: none"> • additional hinge—included in a door frame • cylinder lock insert 31/31 |
- reinforcement for self-closer
 - ventilation undercut
 - pure black edge band of the door leaf (rebated and non-rebated)

Additional information: equipment and accessories

P. 133–137

CRAFT-DESIGN

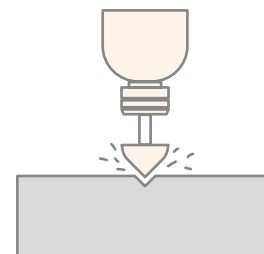

Non-rebated Norma Decor 1 in B134



www.invado.pl



WATCH THE ASSEMBLY VIDEOS ON OUR YOUTUBE CHANNEL

DOOR LEAVES OPTIONS

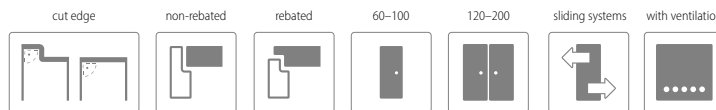

DECORS

ENDURO **



ENDURO 3D **

ENDURO PLUS **



LAMINOLACK ****



DOOR FRAME COLOUR



CONSTRUCTION

- 1** the frame is made of an MDF board
- 2** (STANDARD) "honeycomb" filling
- 3** (OPTIONAL) tubular chipboard filling
- 4** frame with filling is covered with HDF boards on both sides
- 5** door leaf covered with ENDURO foil
 - side edges and upper edge are foiled
 - edge band in the colour of the door leaf
 - cut edges (90°) of door leaf (more info on p. 122)
 - double door leaves have a rebate and a counter-rebate (drawing on p. 122)
 - width of single doors: "60"-"100" / width of double doors: "120"-"200"

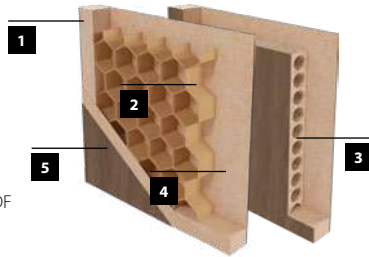

STANDARD EQUIPMENT

- | | |
|-------------|--|
| rebated | <ul style="list-style-type: none"> • lock 72 mm for a standard key, a WC knob, or a cylinder lock insert • screw-in pivot hinges 13.5/9 (white zinc)—2 pcs for door leaves in sizes "60"-"80", 3 pcs for door leaves in sizes "90" and "100" |
| non-rebated | <ul style="list-style-type: none"> • magnetic lock 90 mm for a standard key, 95 mm for a WC knob, and 85 mm for a cylinder lock insert • hidden hinges with a 3D regulation in the colour satin chrome |

DEDICATED DOOR FRAMES

- [OB3] block door frame (possibility to add an architrave 10 x 60 mm or 16 x 80 mm) **P. 125**
- [ORS1] adjustable door frame for rebated doors with a flat angle architrave 60 mm-wide **P. 126**
- [ORS8] adjustable door frame for rebated doors with a flat angle architrave 80 mm-wide **P. 126**
- [ORS7] adjustable door frame for modular non-rebated doors with a flat angle architrave 60 mm-wide **P. 127**
- [ORS10] adjustable door frame for modular non-rebated doors with a flat angle architrave 80 mm-wide **P. 127**
- [ORS4] adjustable 90° door frame for modular non-rebated doors with a flat angle architrave 80 mm-wide **P. 127**
- NOTE: THE OFFER ALSO INCLUDES METAL DOOR FRAMES **P. 128-129**

ADDITIONAL OPTIONS

- door without a keyhole no extra charge
 - door width "100"
 - door made in a non-rebated version for sliding systems
 - double door
 - tubular chipboard filling
 - automatic bottom door seal, widths "60"-"100"
 - aluminium threshold, widths "60"-"100"
- | | |
|-------------|--|
| rebated | <ul style="list-style-type: none"> • additional hinge for the door in sizes "60"-"80" • cylinder lock insert 31/36 • caps for hinges (chrome, satin chrome, golden, black)—set for 1 hinge unit |
| non-rebated | <ul style="list-style-type: none"> • additional hinge for the non-rebated door—included in a door frame • cylinder lock insert 31/31 |
- reinforcement for self-closer
 - ventilation undercut
 - PVC ventilation sleeves
 - metal ventilation sleeves, round (chrome, golden)
 - metal ventilation sleeves, square (chrome, nickel)
 - ventilation grid

Additional information: equipment and accessories

P. 133-137

Non-rebated Lido 10 in B706
 Door frame in B726



www.invado.pl



WATCH THE ASSEMBLY VIDEOS ON OUR YOUTUBE CHANNEL

DOOR LEAVES OPTIONS

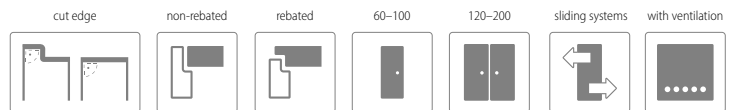

DECORS

ENDURO **

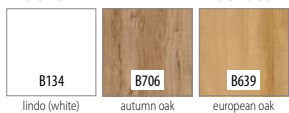

ENDURO 3D **

ENDURO PLUS **



LAMINOLACK ****



DOOR FRAME COLOUR



CONSTRUCTION

- 1** the frame is made of an MDF board
- 2 (STANDARD)** tubular chipboard filling
- 3** frame with filling is covered with HDF boards on both sides
- 4** door leaf covered with ENDURO foil
 - side edges and upper edge are foiled
 - edge band in the colour of door leaf
 - ALU strip—8 mm
 - cut edges (90°) of door leaf (more info on p. 122)
 - double door leaves have a rebate and a counter-rebate (drawing on p. 122)
 - width of single doors: "60"—"100" / width of double doors: "120"—"200"

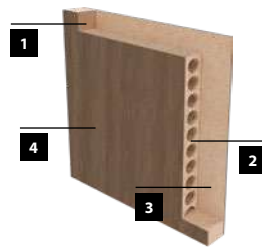

STANDARD EQUIPMENT

- | | |
|-------------|--|
| rebated | <ul style="list-style-type: none"> • lock 72 mm for a standard key, a WC knob, or a cylinder lock insert • screw-in pivot hinges 13.5/9 (white zinc)—2 pcs for door leaves in sizes "60"—"80", 3 pcs for door leaves in sizes "90" and "100" |
| non-rebated | <ul style="list-style-type: none"> • magnetic lock 90 mm for a standard key, 95 mm for a WC knob, and 85 mm for a cylinder lock insert • hidden hinges with a 3D regulation in the colour satin chrome |

DEDICATED DOOR FRAMES

- **[OB3]** block door frame (possibility to add an architrave 10 x 60 mm or 16 x 80 mm) **P. 125**
- **[ORS1]** adjustable door frame for rebated doors with a flat angle architrave 60 mm-wide **P. 126**
- **[ORS8]** adjustable door frame for rebated doors with a flat angle architrave 80 mm-wide **P. 126**
- **[ORS7]** adjustable door frame for modular non-rebated doors with a flat angle architrave 60 mm-wide **P. 127**
- **[ORS10]** adjustable door frame for modular non-rebated doors with a flat angle architrave 80 mm-wide **P. 127**
- **[ORS4]** adjustable 90° door frame for modular non-rebated doors with a flat angle architrave 80 mm-wide **P. 127**
- NOTE: THE OFFER ALSO INCLUDES METAL DOOR FRAMES **P. 128-129**

ADDITIONAL OPTIONS

- | | |
|--|--|
| • door without a keyhole | no extra charge |
| • door width "100" | |
| • door made in a non-rebated version for sliding systems | |
| • double door | |
| • tubular chipboard filling | standard |
| • automatic bottom door seal, widths "60"—"100" | |
| • aluminium threshold, widths "60"—"100" | |
| rebated | <ul style="list-style-type: none"> • cylinder lock insert 31/36 • additional hinge for the door in sizes "60"—"80" • caps for hinges (chrome, satin chrome, golden, black)—set for 1 hinge unit |
| non-rebated | <ul style="list-style-type: none"> • additional hinge—included in a door frame • cylinder lock insert 31/31 |
| • reinforcement for self-closer | |
| • ventilation undercut | |
| • PVC ventilation sleeves | |
| • metal ventilation sleeves, round (chrome, golden) | |
| • metal ventilation sleeves, square (chrome, nickel) | |

Additional information: equipment and accessories

P. 133-137

Non-rebated Dolce 2 in B707



www.in.vadopl



WATCH THE ASSEMBLY VIDEOS ON OUR YOUTUBE CHANNEL

DOOR LEAVES OPTIONS

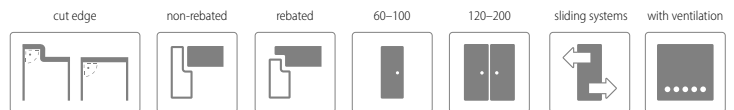

DECORS

ENDURO **

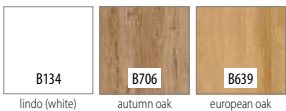

ENDURO 3D **

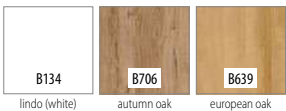

ENDURO PLUS **



LAMINOLACK ****



DOOR FRAME COLOUR

Dolce 1



Dolce 2



Dolce 3

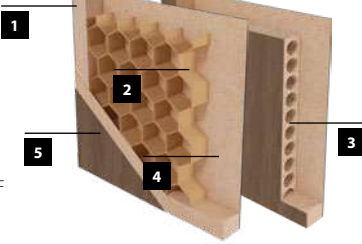

CONSTRUCTION

- 
- 1** the frame is made of an MDF board
 - 2** (STANDARD) "honeycomb" filling
 - 3** (OPTIONAL) tubular chipboard filling
 - 4** frame with filling is covered with HDF boards on both sides
 - 5** door leaf covered with ENDURO foil
 - side edges and upper edge are foiled
 - edge band in the colour of the door leaf
 - cut edges (90°) of door leaf (more info on p. 122)
 - double door leaves have a rebate and a counter-rebate (drawing on p. 122)
 - width of single doors: "60"-"100" / width of double doors: "120"-"200"

STANDARD EQUIPMENT

- | | |
|-------------|--|
| rebated | <ul style="list-style-type: none"> • lock 72 mm for a standard key, a WC knob, or a cylinder lock insert • screw-in pivot hinges 13.5/9 (white zinc)—2 pcs for door leaves in sizes "60"-"80", 3 pcs for door leaves in sizes "90" and "100" |
| non-rebated | <ul style="list-style-type: none"> • magnetic lock 90 mm for a standard key, 95 mm for a WC knob, and 85 mm for a cylinder lock insert • hidden hinges with a 3D regulation in the colour satin chrome |

DEDICATED DOOR FRAMES

- [OB3] block door frame (possibility to add an architrave 10 x 60 mm or 16 x 80 mm) **P. 125**
- [ORS1] adjustable door frame for rebated doors with a flat angle architrave 60 mm-wide **P. 126**
- [ORS8] adjustable door frame for rebated doors with a flat angle architrave 80 mm-wide **P. 126**
- [ORS7] adjustable door frame for modular non-rebated doors with a flat angle architrave 60 mm-wide **P. 127**
- [ORS10] adjustable door frame for modular non-rebated doors with a flat angle architrave 80 mm-wide **P. 127**
- [ORS4] adjustable 90° door frame for modular non-rebated doors with a flat angle architrave 80 mm-wide **P. 127**
- NOTE: THE OFFER ALSO INCLUDES METAL DOOR FRAMES **P. 128-129**

ADDITIONAL OPTIONS

- door without a keyhole no extra charge
 - door width "100"
 - door made in a non-rebated version for sliding systems
 - double door
 - tubular chipboard filling
 - automatic bottom door seal, widths "60"-"100"
 - aluminium threshold, widths "60"-"100"
- | | |
|-------------|--|
| rebated | <ul style="list-style-type: none"> • cylinder lock insert 31/36 • additional hinge for the door in sizes "60"-"80" • caps for hinges (chrome, satin chrome, golden, black)—set for 1 hinge unit |
| non-rebated | <ul style="list-style-type: none"> • additional hinge—included in a door frame • cylinder lock insert 31/31 |
- reinforcement for self-closer
 - ventilation undercut
 - PVC ventilation sleeves
 - metal ventilation sleeves, round (chrome, golden)
 - metal ventilation sleeves, square (chrome, nickel)

Additional information: equipment and accessories

P. 133-137

GLASS

the glossy side of glass is on the hinge side





Non-rebated Virgo 2 in B708

www.invado.pl



WATCH THE ASSEMBLY VIDEOS ON OUR YOUTUBE CHANNEL

DOOR LEAVES OPTIONS

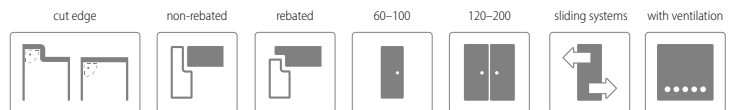

DECORS

ENDURO **

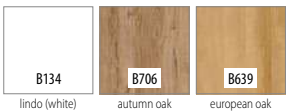

ENDURO 3D **

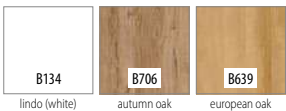

ENDURO PLUS **



LAMINOLACK ****



DOOR FRAME COLOUR

Virgo 1



Virgo 2



Virgo 3



CONSTRUCTION

- | | | | |
|---|--|---|--|
| 1 | the frame is made of an MDF board | 1 | |
| 2 | (STANDARD)
"honeycomb" filling | 2 | |
| 3 | (OPTIONAL)
tubular chipboard filling | 3 | |
| 4 | frame with filling is covered with HDF boards on both sides | 4 | |
| 5 | door leaf covered with ENDURO foil <ul style="list-style-type: none"> • side edges and upper edge are foiled • edge band in the colour of the door leaf • cut edges (90°) of door leaf (more info on p. 122) • double door leaves have a rebate and a counter-rebate (drawing on p. 122) • width of single doors: "60"-"100" / width of double doors: "120"-"200" | 5 | |

STANDARD EQUIPMENT

- | | |
|-------------|--|
| rebated | <ul style="list-style-type: none"> • lock 72 mm for a standard key, a WC knob, or a cylinder lock insert • screw-in pivot hinges 13.5/9 (white zinc)—2 pcs for door leaves in sizes "60"-"80", 3 pcs for door leaves in sizes "90" and "100" |
| non-rebated | <ul style="list-style-type: none"> • magnetic lock 90 mm for a standard key, 95 mm for a WC knob, and 85 mm for a cylinder lock insert • hidden hinges with a 3D regulation in the colour satin chrome |

DEDICATED DOOR FRAMES

- **[OB3]** block door frame (possibility to add an architrave 10 x 60 mm or 16 x 80 mm) **P. 125**
- **[ORS1]** adjustable door frame for rebated doors with a flat angle architrave 60 mm-wide **P. 126**
- **[ORS8]** adjustable door frame for rebated doors with a flat angle architrave 80 mm-wide **P. 126**
- **[ORS7]** adjustable door frame for modular non-rebated doors with a flat angle architrave 60 mm-wide **P. 127**
- **[ORS10]** adjustable door frame for modular non-rebated doors with a flat angle architrave 80 mm-wide **P. 127**
- **[ORS4]** adjustable 90° door frame for modular non-rebated doors with a flat angle architrave 80 mm-wide **P. 127**
- NOTE: THE OFFER ALSO INCLUDES METAL DOOR FRAMES **P. 128-129**

ADDITIONAL OPTIONS

- door without a keyhole no extra charge
 - door width "100"
 - door made in a non-rebated version for sliding systems
 - double door
 - tubular chipboard filling
 - automatic bottom door seal, widths "60"-"100"
 - aluminium threshold, widths "60"-"100"
- | | |
|-------------|--|
| rebated | <ul style="list-style-type: none"> • cylinder lock insert 31/36 • additional hinge for the door in sizes "60"-"80" • caps for hinges (chrome, satin chrome, golden, black)—set for 1 hinge unit |
| non-rebated | <ul style="list-style-type: none"> • additional hinge—included in a door frame • cylinder lock insert 31/31 |
- reinforcement for self-closer
 - ventilation undercut
 - PVC ventilation sleeves
 - metal ventilation sleeves, round (chrome, golden)
 - metal ventilation sleeves, square (chrome, nickel)

Additional information: equipment and accessories

P. 133-137

GLASS

the glossy side of glass is on the hinge side



Non-rebated Orso 3 in B705



WATCH THE ASSEMBLY VIDEOS ON OUR YOUTUBE CHANNEL

DOOR LEAVES OPTIONS

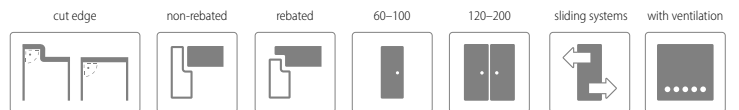

DECORS

ENDURO **

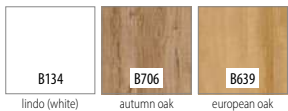

ENDURO 3D **

ENDURO PLUS **



LAMINOLACK ****



DOOR FRAME COLOUR



CONSTRUCTION

- 1** the frame is made of an MDF board
- 2** (STANDARD) "honeycomb" filling
- 3** (OPTIONAL) tubular chipboard filling
- 4** frame with filling is covered with HDF boards on both sides
- 5** door leaf covered with ENDURO foil
 - side edges and upper edge are foiled
 - edge band in the colour of the door leaf
 - cut edges (90°) of door leaf (more info on p. 122)
 - double door leaves have a rebate and a counter-rebate (drawing on p. 122)
 - width of single doors: "60"–"100" / width of double doors: "120"–"200"

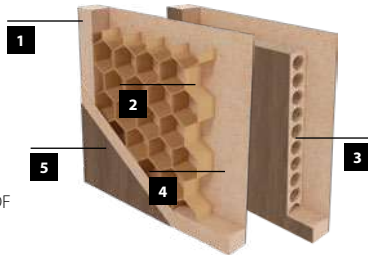

ADDITIONAL OPTIONS

- door without a keyhole no extra charge
 - door width "100"
 - door made in a non-rebated version for sliding systems
 - double door
 - tubular chipboard filling
 - automatic bottom door seal, widths "60"–"100"
 - aluminium threshold, widths "60"–"100"
- | | |
|-------------|--|
| rebated | <ul style="list-style-type: none"> • cylinder lock insert 31/36 • additional hinge for the door in sizes "60"–"80" • caps for hinges (chrome, satin chrome, golden, black)—set for 1 hinge unit |
| non-rebated | <ul style="list-style-type: none"> • additional hinge—included in a door frame • cylinder lock insert 31/31 |
- reinforcement for self-closer
 - ventilation undercut
 - PVC ventilation sleeves
 - metal ventilation sleeves, round (chrome, golden)
 - metal ventilation sleeves, square (chrome, nickel)

Additional information: equipment and accessories

P. 133–137

STANDARD EQUIPMENT

- | | |
|-------------|--|
| rebated | <ul style="list-style-type: none"> • lock 72 mm for a standard key, a WC knob, or a cylinder lock insert • screw-in pivot hinges 13.5/9 (white zinc)—2 pcs for door leaves in sizes "60"–"80", 3 pcs for door leaves in sizes "90" and "100" |
| non-rebated | <ul style="list-style-type: none"> • magnetic lock 90 mm for a standard key, 95 mm for a WC knob, and 85 mm for a cylinder lock insert • hidden hinges with a 3D regulation in the colour satin chrome |

DEDICATED DOOR FRAMES

- [OB3] block door frame (possibility to add an architrave 10 x 60 mm or 16 x 80 mm) P. 125
- [ORS1] adjustable door frame for rebated doors with a flat angle architrave 60 mm-wide P. 126
- [ORS8] adjustable door frame for rebated doors with a flat angle architrave 80 mm-wide P. 126
- [ORS7] adjustable door frame for modular non-rebated doors with a flat angle architrave 60 mm-wide P. 127
- [ORS10] adjustable door frame for modular non-rebated doors with a flat angle architrave 80 mm-wide P. 127
- [ORS4] adjustable 90° door frame for modular non-rebated doors with a flat angle architrave 80 mm-wide P. 127
- NOTE: THE OFFER ALSO INCLUDES METAL DOOR FRAMES P. 128–129

GLASS

the glossy side of glass is on the hinge side



Double non-rebated Merano 5 in B639
Door frame in B134



www.invado.pl



WATCH THE ASSEMBLY VIDEOS ON OUR YOUTUBE CHANNEL

DOOR LEAVES OPTIONS

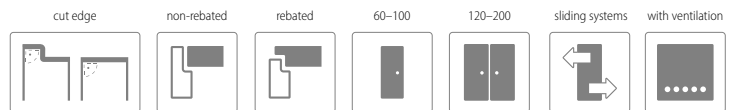

DECORS

ENDURO **



B134

lindo (white)



B706

autumn oak



B639

european oak

ENDURO 3D **

ENDURO PLUS **



B705

spring oak



B707

winter oak



B708

siberian larch

LAMINOLACK ****



B726

pure black

DOOR FRAME COLOUR

Merano 1



Merano 2



Merano 3



Merano 4



Merano 5



CONSTRUCTION

- 1** the frame is made of an MDF board
- 2** (STANDARD) "honeycomb" filling
- 3** (OPTIONAL) tubular chipboard filling
- 4** frame with filling is covered with HDF boards on both sides
- 5** door leaf covered with ENDURO foil
 - side edges and upper edge are foiled
 - edge band in the colour of the door leaf
 - cut edges (90°) of door leaf (more info on p. 122)
 - double door leaves have a rebate and a counter-rebate (drawing on p. 122)
 - width of single doors: "60"–"100" / width of double doors: "120"–"200"

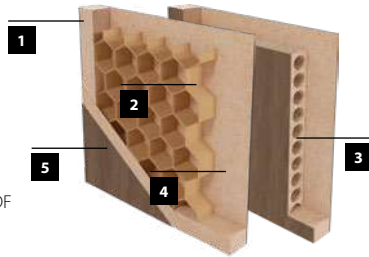

STANDARD EQUIPMENT

- | | |
|-------------|--|
| rebated | <ul style="list-style-type: none"> • lock 72 mm for a standard key, a WC knob, or a cylinder lock insert • screw-in pivot hinges 13.5/9 (white zinc)—2 pcs for door leaves in sizes "60"–"80", 3 pcs for door leaves in sizes "90" and "100" |
| non-rebated | <ul style="list-style-type: none"> • magnetic lock 90 mm for a standard key, 95 mm for a WC knob, and 85 mm for a cylinder lock insert • hidden hinges with a 3D regulation in the colour satin chrome |

DEDICATED DOOR FRAMES

- [OB3] block door frame (possibility to add an architrave 10 x 60 mm or 16 x 80 mm) **P. 125**
- [ORS1] adjustable door frame for rebated doors with a flat angle architrave 60 mm-wide **P. 126**
- [ORS8] adjustable door frame for rebated doors with a flat angle architrave 80 mm-wide **P. 126**
- [ORS7] adjustable door frame for modular non-rebated doors with a flat angle architrave 60 mm-wide **P. 127**
- [ORS10] adjustable door frame for modular non-rebated doors with a flat angle architrave 80 mm-wide **P. 127**
- [ORS4] adjustable 90° door frame for modular non-rebated doors with a flat angle architrave 80 mm-wide **P. 127**
- NOTE: THE OFFER ALSO INCLUDES METAL DOOR FRAMES **P. 128-129**

ADDITIONAL OPTIONS

- door without a keyhole no extra charge
 - door width "100"
 - door made in a non-rebated version for sliding systems
 - double door
 - tubular chipboard filling
 - automatic bottom door seal, widths "60"–"100"
 - aluminium threshold, widths "60"–"100"
- | | |
|-------------|--|
| rebated | <ul style="list-style-type: none"> • cylinder lock insert 31/36 • additional hinge for the door in sizes "60"–"80" • caps for hinges (chrome, satin chrome, golden, black)—set for 1 hinge unit |
| non-rebated | <ul style="list-style-type: none"> • additional hinge—included in a door frame • cylinder lock insert 31/31 |
- reinforcement for self-closer
 - ventilation undercut
 - PVC ventilation sleeves
 - metal ventilation sleeves, round (chrome, golden)
 - metal ventilation sleeves, square (chrome, nickel)

Additional information: equipment and accessories **P. 133–137**

GLASS

the glossy side of glass is on the hinge side



Non-rebated Norma Decor 1 in B746

Door frame in B687



OPTIMO
duo line

www.invadopl

DOOR LEAF WITH
THE B726 EDGE BAND



WATCH THE
ASSEMBLY VIDEOS
ON OUR YOUTUBE
CHANNEL

DOOR LEAVES OPTIONS

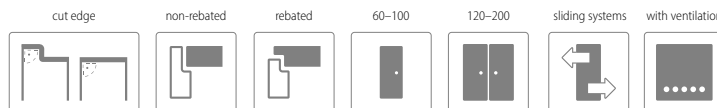

DECORS

CPL 0.15 MM CPL 0.8 MM



LAMINOLACK **NEW**





CONSTRUCTION

-
- 1** the frame is made of an MDF board
 - 2** (STANDARD) "honeycomb" filling
 - 3** (OPTIONAL) tubular chipboard filling
 - 4** frame with filling is covered with HDF boards on both sides
 - 5** door leaf covered with the CPL 0.15 mm, CPL 0.8 mm foil or LAMINOLACK
 - side edges and upper edge are foiled
 - edge band in the colour of the door leaf; option for non-rebated doors (see table on page 10). In double non-rebated door leaves, edge band in the colour of the door leaf and silver fittings are standard. However, it is possible to make them with pure black edge band and fittings as part of a custom order. In this case, please contact our Customer Service.
 - cut edges (90°) of the door leaf (more info on p. 122)
 - double door leaves have a rebate and a counter-rebate (drawing on p. 122)
 - width of single doors: "60"–"100" / width of double doors: "120"–"200"

STANDARD EQUIPMENT

- | | |
|-------------|--|
| rebated | <ul style="list-style-type: none"> • lock 72 mm for a standard key, a WC knob, or a cylinder lock insert • screw-in pivot hinges 13.5/9 (white zinc)—2 pcs for door leaves in sizes "60"–"80", 3 pcs for door leaves in sizes "90" and "100" |
| non-rebated | <ul style="list-style-type: none"> • magnetic lock 90 mm for a standard key, 95 mm for a WC knob, and 85 mm for a cylinder lock insert • hidden hinges with a 3D regulation in the colour satin chrome |

DEDICATED DOOR FRAMES

- | | |
|--|------------|
| • [OB3] block door frame (possibility to add an architrave 10 x 60 mm or 16 x 80 mm) | P. 125 |
| • [ORS1] adjustable door frame for rebated doors with a flat angle architrave 60 mm-wide | P. 126 |
| • [ORS8] adjustable door frame for rebated doors with a flat angle architrave 80 mm-wide | P. 126 |
| • [ORS7] adjustable door frame for modular non-rebated doors with a flat angle architrave 60 mm-wide | P. 127 |
| • [ORS10] adjustable door frame for modular non-rebated doors with a flat angle architrave 80 mm-wide | P. 127 |
| • [ORS4] adjustable 90° door frame for modular non-rebated doors with a flat angle architrave 80 mm-wide | P. 127 |
| • NOTE: THE OFFER ALSO INCLUDES METAL DOOR FRAMES | P. 128-129 |

ADDITIONAL OPTIONS

- | | |
|--|--|
| • door without a keyhole | no extra charge |
| • door width "100"—CPL 0.15 mm | |
| • door width "100"—CPL 0.8 mm | |
| • door made in a non-rebated version for sliding systems | |
| • double door | |
| • tubular chipboard filling | |
| • automatic bottom door seal, widths "60"–"100" | |
| • aluminium threshold, widths: "60"–"100" | |
| rebated | <ul style="list-style-type: none"> • cylinder lock insert 31/36 • additional hinge for the door in sizes "60"–"80" • caps for hinges (chrome, satin chrome, golden, black)—set for 1 hinge unit |
| non-rebated | <ul style="list-style-type: none"> • additional hinge for the non-rebated door—included in a door frame • cylinder lock insert 31/31 • edge band in the following colours: B726 or B688 • edge band in the colour: B717 (option only for the leaf in B687, B688) • a set of: 2 hinges + striking plate + door lock in colours: white, satin chrome, golden, black |
| • reinforcement for self-closer | |
| • ventilation undercut | |
| • PVC ventilation sleeves | |
| • metal ventilation sleeves, round (chrome, golden) | |
| • metal ventilation sleeves, square (chrome, nickel) | |
| • ventilation grid | |

Additional information: equipment and accessories **P. 133–137**



PORTHOLE in NORMA DECOR 6: available in silver and black colour with the possibility of using a transparent or satin glass pane (option included in the price of the door leaf)

Non-rebated Lido 17 in B747
Door frame in B687



OPTIMO
duo line

www.invado.pl

DOOR LEAF WITH
THE B688 EDGE BAND



WATCH THE
ASSEMBLY VIDEOS
ON OUR YOUTUBE
CHANNEL

DOOR LEAVES OPTIONS

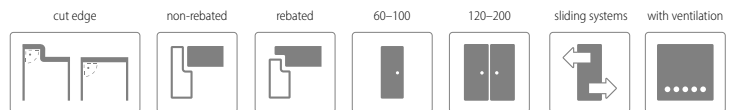

DECORS

CPL 0.15 MM -----



LAMINOLACK -----



CONSTRUCTION

- 1** the frame is made of an MDF board
- 2 (STANDARD)** tubular chipboard filling
- 3** frame with filling is covered with HDF boards on both sides
- 4** door leaf covered with the CPL 0.15 mm
 - side edges and upper edge are foiled
 - edge band in the colour of the door leaf; option for non-rebated doors (see table on page 10). In double non-rebated door leaves, edge band in the colour of the door leaf and silver fittings are standard. However, it is possible to make them with pure black edge band and fittings as part of a custom order. In this case, please contact our Customer Service.
 - ALU strip—8 mm
 - cut edges (90°) of the door leaf (more info on p. 122)
 - double door leaves have a rebate and a counter-rebate (drawing on p. 122)
 - width of single doors: "60"—"100" / width of double doors: "120"—"200"

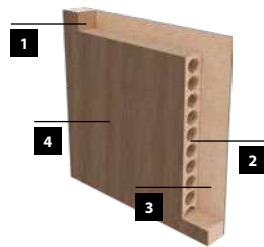

STANDARD EQUIPMENT

- | | |
|-------------|--|
| rebated | <ul style="list-style-type: none"> • lock 72 mm for a standard key, a WC knob, or a cylinder lock insert • screw-in pivot hinges 13.5/9 (white zinc)—2 pcs for door leaves in sizes "60"—"80", 3 pcs for door leaves in sizes "90" and "100" |
| non-rebated | <ul style="list-style-type: none"> • magnetic lock 90 mm for a standard key, 95 mm for a WC knob, and 85 mm for a cylinder lock insert • hidden hinges with a 3D regulation in the colour satin chrome |

DEDICATED DOOR FRAMES

- **[OB3]** block door frame (possibility to add an architrave 10 x 60 mm or 16 x 80 mm) **P. 125**
- **[ORS1]** adjustable door frame for rebated doors with a flat angle architrave 60 mm-wide **P. 126**
- **[ORS8]** adjustable door frame for rebated doors with a flat angle architrave 80 mm-wide **P. 126**
- **[ORS7]** adjustable door frame for modular non-rebated doors with a flat angle architrave 60 mm-wide **P. 127**
- **[ORS10]** adjustable door frame for modular non-rebated doors with a flat angle architrave 80 mm-wide **P. 127**
- **[ORS4]** adjustable 90° door frame for modular non-rebated doors with a flat angle architrave 80 mm-wide **P. 127**
- NOTE: THE OFFER ALSO INCLUDES METAL DOOR FRAMES **P. 128-129**

ADDITIONAL OPTIONS

- door without a keyhole no extra charge
 - door width "100"—CPL 0.15 mm
 - door made in a non-rebated version for sliding systems
 - double door
 - automatic bottom door seal, widths "60"—"100"
 - aluminium threshold, widths: "60"—"100"
- | | |
|-------------|--|
| rebated | <ul style="list-style-type: none"> • cylinder lock insert 31/36 • additional hinge for the door in sizes "60"—"80" • caps for hinges (chrome, satin chrome, golden, black)—set for 1 hinge unit |
| non-rebated | <ul style="list-style-type: none"> • additional hinge for the non-rebated door—included in a door frame • cylinder lock insert 31/31 • edge band in the following colours: B726 or B688 • edge band in the colour: B717 (option only for the leaf in B687) • a set of: 2 hinges + striking plate + door lock in colours: white, satin chrome, golden, black |
- reinforcement for self-closer
 - ventilation undercut
 - PVC ventilation sleeves
 - metal ventilation sleeves, round (chrome, golden)
 - metal ventilation sleeves, square (chrome, nickel)

Additional information: equipment and accessories

P. 133–137

Amber 14 with a door frame in B726



www.invadopl



ASSEMBLY AND
INSTALLATION
OF AMBER GLASS
DOORS

LOCK COLOURS

Anodized silver [F150]

Stainless steel [F157]

Black

DOOR LEAVES OPTIONS

60-90

with ventilation



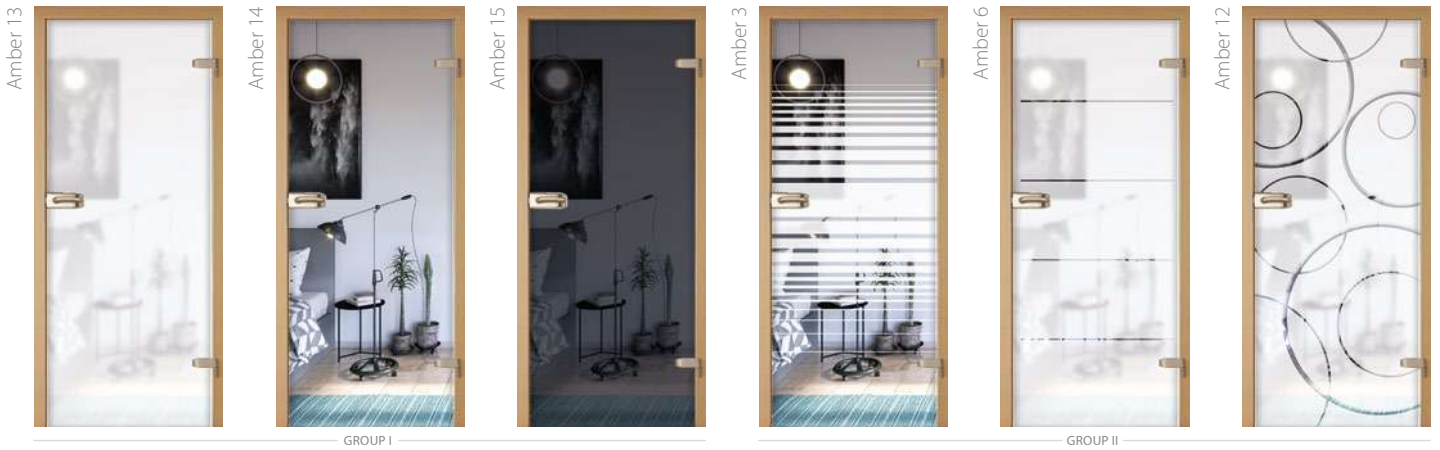

Amber doors are divided into groups due to the types of glass decorations

GROUP I—basic glass
(transparent or matte in various shades)

- Amber 13—*satinato* glass
- Amber 14—*transparent* glass
- Amber 15—*transparent* glass

GROUP II—decorated glass
(engraving or overprint)

- Amber 3—*overprint on transparent* glass
- Amber 6—*overprint on transparent* glass
- Amber 12—*engraving on satinato* glass

CONSTRUCTION

- tempered glass, 8 mm thick
- the matt side of a glass pane is on the hinge side
- block or adjustable door frame, 2 hinges

DIMENSIONS OF GLASS DOORS (mm)

	"60"	"70"	"80"	"90"
door leaf width	617	717	817	917
door leaf height	(PL) 2027 / 1975 (CZ/SK)			

DEDICATED DOOR FRAMES

- [OB3] block door frame (possibility to add an architrave 10 x 60 mm or 16 x 80 mm) P. 125
- [ORS1] adjustable door frame for rebated doors with a flat angle architrave 60 mm-wide P. 126
- [ORS8] adjustable door frame for rebated doors with a flat angle architrave 80 mm-wide P. 126

ADDITIONAL OPTIONS

- ventilation undercut

LOCKS



Libra in B639



www.invado.pl

DOOR LEAVES OPTIONS

60-90



DECORS

ENDURO **

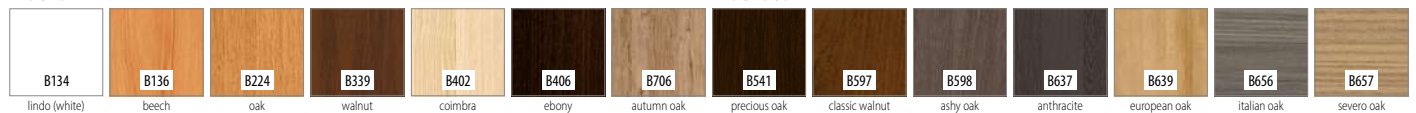

ENDURO 3D **

ENDURO PLUS **



ECO-VENEER FORTE ***

ECO-VENEER CPL ***

LAMINOLACK ****

DOOR FRAME COLOUR

HORIZONTAL

Folding doors—NORMA DECOR 1



Folding doors—LIBRA



CONSTRUCTION

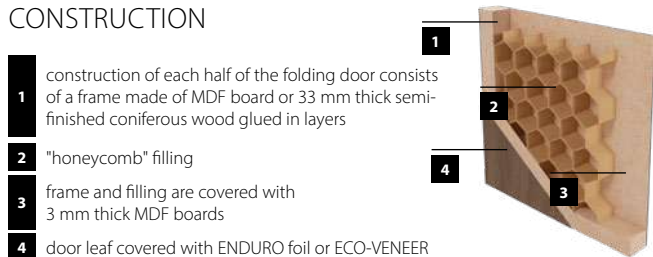

- 1** construction of each half of the folding door consists of a frame made of MDF board or 33 mm thick semi-finished coniferous wood glued in layers
 - 2** "honeycomb" filling
 - 3** frame and filling are covered with 3 mm thick MDF boards
 - 4** door leaf covered with ENDURO foil or ECO-VENEER
- folding doors consist of a folding door and a block or adjustable door frame
 - each half of a door leaf has a rabbet along the vertical edge
 - both parts of a door leaf are joined together with hidden hinges
 - the door leaf is connected to the floor with a spigot fixed in the holder, which is bolted to the floor
 - the upper part is connected to the door frame with a spigot fixed in the holder, which is mounted in the rail bolted to the upper element of the door frame
 - the sliding mechanism (trolley), mounted on the rail, stabilizes the door leaf when opening and closing
 - rounded vertical edges of door leaves (more info on p. 122)
 - universal door leaf ready to be mounted on the left or right side
 - width of single doors: "60"- "90"

STANDARD EQUIPMENT

- 2 silver round grips in colour satin chrome
- 2 hidden hinges in colour satin chrome



DEDICATED DOOR FRAMES

- **[OB3]** block door frame (possibility to add an architrave 10 x 60 mm or 16 x 80 mm) P. 125
- **[ORS1]** adjustable door frame for rebated doors with a flat angle architrave 60 mm-wide P. 126
- **[ORS8]** adjustable door frame for rebated doors with a flat angle architrave 80 mm-wide P. 126

GLASS

the glossy side of glass is on the hinge side



Aversa 1 in a sliding system in B490



www.invado.pl

The cassette with thickness 100 mm is designed for modular door leaves (eg. Domino, Versano, Tamparo) and standard flat doors.

The cassette with thickness 125 mm is designed for standard foiled door leaves (eg. Torino, Strada).

DOOR LEAVES OPTIONS

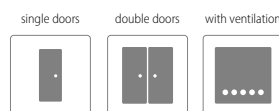

STANDARD EQUIPMENT (THE SET INCLUDES)

- construction cassette for the sliding system in sizes "100" or "125"
- set of profiles (door frame), brushes and seals
- set of covering profiles for both sides of the door frame
- grip (chrome, satin, golden or black)

ADDITIONAL OPTIONS

- soft-close hardware for sliding door
- key hook lock or WC hook lock (chrome, satin, golden, black) with a grip suitable for key or WC lock. In case of door leaves equipped with a hook lock, the customer installs the striking plate in the door frame on their own
- tunnel (door frame enlarging element)—price per each 10 mm
- strike plate

- key
- WC

DIAGRAM OF THE LOCATION OF DOOR FRAME ELEMENTS FOR SLIDING SYSTEM—SINGLE SLIDING SYSTEM

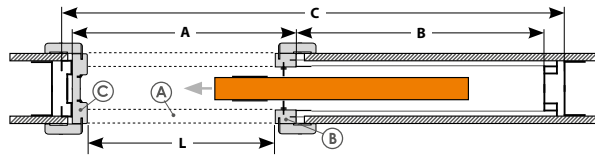
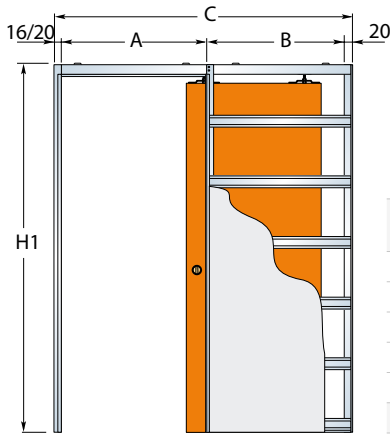

DIMENSIONS OF THE CASSETTE FOR SINGLE SLIDING SYSTEM (mm)				DOOR LEAF DIMENSIONS (mm)		
internal width L x H	outer width C x H1	A	B	wall thickness	width	height
610 x 2075 (PL) / 2025 (CZ-SK)	1346 x 2115 (PL) / 2065 (CZ-SK)	670	640	100-125	644	2040 (PL) 1988 (CZ-SK)
710 x 2075 (PL) / 2025 (CZ-SK)	1546 x 2115 (PL) / 2065 (CZ-SK)	770	740		744	
810 x 2075 (PL) / 2025 (CZ-SK)	1746 x 2115 (PL) / 2065 (CZ-SK)	870	840		844	
910 x 2075 (PL) / 2025 (CZ-SK)	1946 x 2115 (PL) / 2065 (CZ-SK)	970	940		944	
1010 x 2075 (PL) / 2025 (CZ-SK)	2146 x 2115 (PL) / 2065 (CZ-SK)	1070	1040		1044	

H—internal height of the cassette; **H1**—outer height of the cassette; **L**—internal width of the cassette; **C**—outer width of the cassette;

DIAGRAM OF THE LOCATION OF DOOR FRAME ELEMENTS FOR SLIDING SYSTEM—DOUBLE SLIDING SYSTEM

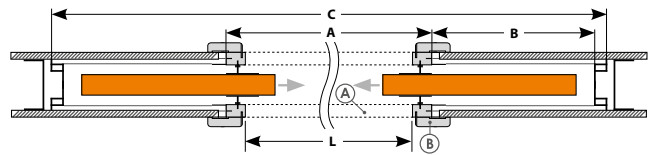
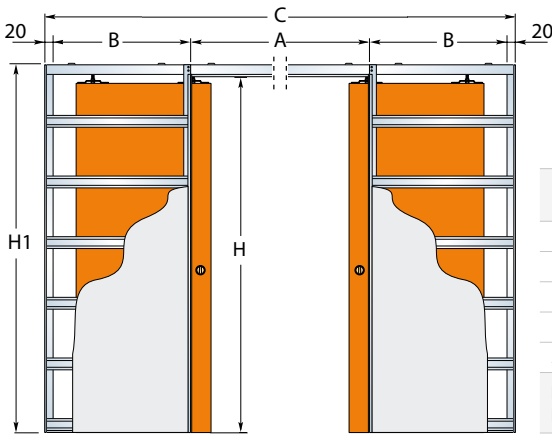

DIMENSIONS OF THE CASSETTE FOR DOUBLE SLIDING SYSTEM (mm)				DOOR LEAF DIMENSIONS (mm)		
internal width L x H	outer width C x H1	A	B	wall thickness	width	height
1224 x 2075 (PL) / 2025 (CZ-SK)	2610 x 2115 (PL) / 2065 (CZ-SK)	1290	640	100-125	644	2040 (PL) 1988 (CZ-SK)
1424 x 2075 (PL) / 2025 (CZ-SK)	3010 x 2115 (PL) / 2065 (CZ-SK)	1490	740		744	
1624 x 2075 (PL) / 2025 (CZ-SK)	3410 x 2115 (PL) / 2065 (CZ-SK)	1690	840		844	
1824 x 2075 (PL) / 2025 (CZ-SK)	3810 x 2115 (PL) / 2065 (CZ-SK)	1890	940		944	
2024 x 2075 (PL) / 2025 (CZ-SK)	4210 x 2115 (PL) / 2065 (CZ-SK)	2090	1040		1044	

H—internal height of the cassette; **H1**—outer height of the cassette; **L**—internal width of the cassette; **C**—outer width of the cassette;

DIAGRAM OF THE LOCATION OF DOOR FRAME ENLARGING ELEMENTS FOR THE POCKET DOOR SLIDING SYSTEM

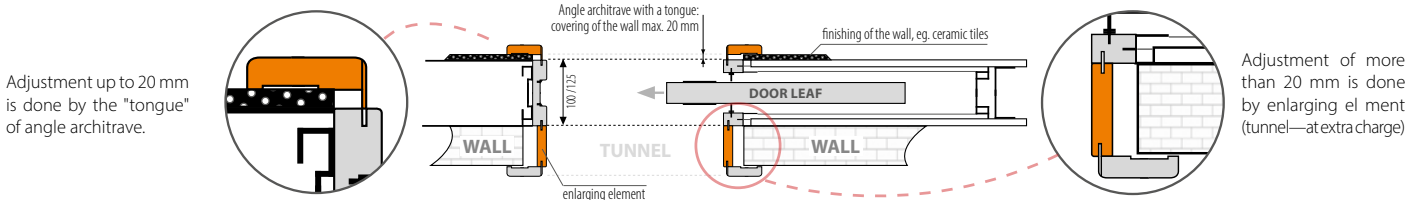

CASSETTE ELEMENTS

A—upper profile + angle architrave; **B**—vertical profile + angle architrave; **C**—fender beam + angle architrave

Dimensions of cassette elements (mm)	a1	a2	a3	a4	b1	b2	b3	b4	c1	c2	c3	c4	c5
cassette 100	19	50	25	10	19	33	7	10	25	7	50	12	2073 (PL) 1988 (CZ-SK)
cassette 125 (PL)	25				25							25	



Norma Decor 1 in a sliding system in B687



www.invado.pl



WATCH:
ASSEMBLY AND
INSTALLATION OF
WALL-MOUNTED
SLIDING SYSTEM

DOOR LEAVES OPTIONS

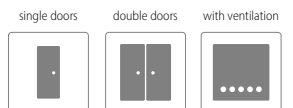

STANDARD EQUIPMENT (THE SET INCLUDES)

- rail cover in the door leaf decor—installed on ALU strip (two types, depending on the width of the masking angle architrave used in the door frame—60 mm or 80 mm)
- rail—installed on ALU strip
- grip—a set for both sides of the door leaf, and a thimble—1 piece (chrome, satin, golden, black)

ADDITIONAL OPTIONS AT EXTRA CHARGE

- soft-close hardware for sliding door

- bumper

- key hook lock or WC hook lock (chrome, satin, golden, black) with a grip suitable for key or WC lock

- ENDURO / PLUS / 3D
- ECO-VENEER / LAMINOLACK
- CPL 0,15 mm
- key
- WC

DIMENSIONS OF THE DOOR LEAF AND THE DOOR FRAME FOR THE WALL-MOUNTED SLIDING SYSTEM

		door frame for single door (mm)					door frame for double door (mm) – ATTENTION: CHANGE OF DIMENSIONS									
		"60"	"70"	"80"	"90"	"100"	"120"	"130"	"140"	"150"	"160"	"170"	"180"	"190"	"200"	
s1	door leaf width	644	744	844	944	1044	1288	1388	1488	1588	1688	1788	1888	1988	2088	
s2	width of the wall opening*	674	774	874	974	1074	1310	1410	1510	1610	1710	1810	1910	2010	2110	
s3	outer width of the door frame	644	744	844	944	1044	1280	1380	1480	1580	1680	1780	1880	1980	2080	
s4	internal width of the door frame	600	700	800	900	1000	1236	1336	1436	1536	1636	1736	1836	1936	2036	
s5	width of the door frame with architraves	60 mm [ORS3]	744	844	944	1044	1144	1380	1480	1580	1680	1780	1880	1980	2080	2180
		80 mm [ORS9]	784	884	984	1084	1184	1420	1520	1620	1720	1820	1920	2020	2120	2220
h1	door leaf height	2040 (PL) / 1988 (CZ-SK)														
h2	height of the wall opening	2062 (PL) / 2008 (CZ-SK)														
h3	outer height of the door frame	2047 (PL) / 1993 (CZ-SK)														
h4	internal height of the door frame*	2025 (PL) / 1971 (CZ-SK)														
h5	height of the door frame with architraves	60 mm [ORS3]	2097 (PL) / 2043 (CZ-SK)													
		80 mm [ORS9]	2117 (PL) / 2063 (CZ-SK)													

*Dimensions of the wall opening for the version without a door frame should be identical to the internal width of the door frame.

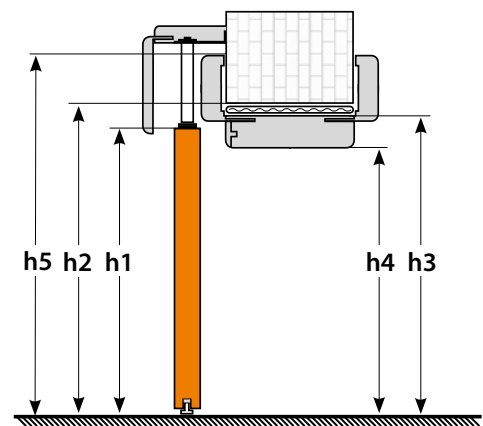
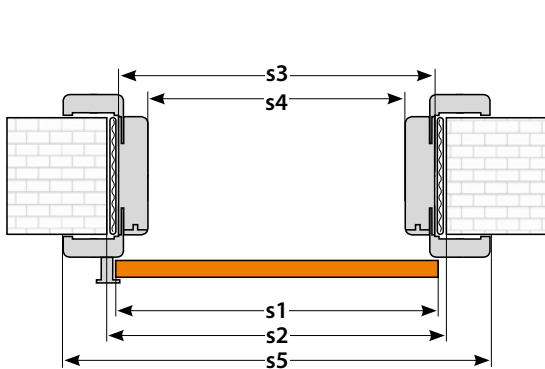

AVAILABLE DOOR FRAMES

[ORS3] adjustable door frame with a flat angle architrave 60 mm-wide
the set includes: a door frame and a bumper with milling and striking plate

[ORS9] adjustable door frame with a flat angle architrave 80 mm-wide
the set includes: a door frame and a bumper with milling and striking plate

CLASSIFICATION OF RAILS AND RAIL COVERS DEPENDING ON THE WIDTH OF THE SLIDING SYSTEM

door leaf	length of rail cover	number of rail cover elements	number of rails and angle architraves	length of rail cover	length of rail cover	number of rail cover elements	number of rails and angle architraves	
"60"	1350 mm	1 element	1 rail and angle architrave 200 cm-long	"70" + "70" or "60" + "80"	3000 mm	2 elements	2 rails and angle architraves 200 cm-long	
"70"	1550 mm			"70" + "80" or "60" + "90"	3200 mm			
"80"	1750 mm			"80" + "80" or "70" + "90" or "60" + "100"	3400 mm			
"90"	1950 mm			"80" + "90" or "70" + "100"	3600 mm			
"100"	2150 mm			"90" + "90" or "80" + "100"	3800 mm			
"60" + "60"	2600 mm	2 elements	2 rails and angle architraves 200 cm-long	"90" + "100"	4000 mm			3 rails and angle architraves 200 cm-long
"60" + "70"	2800 mm			"100" + "100"	4200 mm			





Egida in B637



INSTALLATION OF
EGIDA DOORS

DOOR LEAVES OPTIONS

EGIDA door has burglary resistance (RC 2) only when purchased with a complete dedicated set, which includes a door leaf with a door frame, a threshold, a handle with an escutcheon in min. class 2, and a cylinder insert in min. class 4.



DECORS

ENDURO **

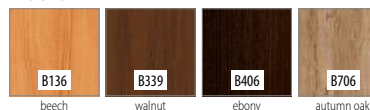

VERTICAL +
HORIZONTAL

ENDURO 3D **



HORIZONTAL



ENDURO PLUS **



ECO-VENNER FORTE ***



ECO-VENEER CPL ***





CONSTRUCTION

- 1 frame is made of plywood
- 2 filling element: tubular chipboard
- 3 frame with filling is covered with HDF boards on both sides
- 4 door leaf covered with ENDURO foil or ECO-VENEER
 - door leaf thickness: 40 mm
 - cut edges (90°) of the door leaf (more info on p. 122)
 - width of single doors: "80"–"100"

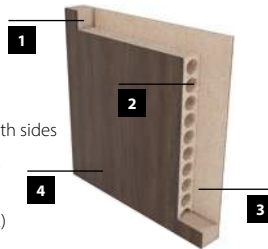

ADDITIONAL OPTIONS

- handle + QUEBECK shield—anti-burglary resistance class II (color INOX and TITAN)
- handle + ROYAL shield—anti-burglary resistance class III (color INOX)
- set of WILKA cylinder lock inserts (insert + insert with a knob), ANTI-BURGLARY resistance class 2, 30 x 40 mm, 6 keys
- panoramic viewfinder
- automatic door bottom seal for doors "80"–"100"

NOTE: automatic bottom door seal is not applicable for doors with fixed threshold, therefore it is not included in the set.

STANDARD EQUIPMENT

- multipoint strip lock with 3 security bolts
- 3 reinforced hinges + 3 anti-burglary pins
- acoustic insulation $R_w = 29$ dB (acoustic insulation class $R_w = 27$ dB)
- ANTI-BURGLARY resistance class RC2
- fixed aluminium threshold



DIMENSIONS

		wooden door frame [KOB A] (mm)			metal door frame [KOB M] (mm)		
		"80"	"90"	"100"	"80"	"90"	"100"
s1	door leaf width	844	944	1044	844	944	1044
s2	width of the wall opening	920	1020	1120	890	990	1090
s3	outer width of the door frame	890	990	1090	880	980	1080
s4	internal width of the door frame	802	902	1002	800	900	1000
s5	width of the door frame with architraves	--	--	--	906	1006	1106
h1	door leaf height	2040 (PL) / 1988 (CZ-SK)			2040 (PL)		
h2	internal height of the door frame	2084 (PL) / 2030 (CZ-SK)			2070 (PL)		
h3	outer height of the door frame	2069 (PL) / 2015 (CZ-SK)			2064 (PL)		
h4	internal height of the door frame	2025 (PL) / 1971 (CZ-SK)			2024 (PL)		
h5	height of the door frame with architraves	--			2077 (PL)		

DEDICATED DOOR FRAMES

[KOB A]—block door frame: 90 x 44 mm made of plywood covered with MDF board—width "80"–"100"

[KOB M]—metal door frame in RAL color: available as standard in brown color (8017) other colors—honey (8003), white (9010), beige (1001) and grey (7047)*—width "80"–"100"

*ATTENTION: Metal door frame in non-standard decors are available per request with longer production time.

TECHNICAL DOORS IGNIS ARE CERTIFIED TO BE SOLD IN POLAND, CZECH REPUBLIC AND SLOVAKIA

Ignis in B587

www.invado.pl

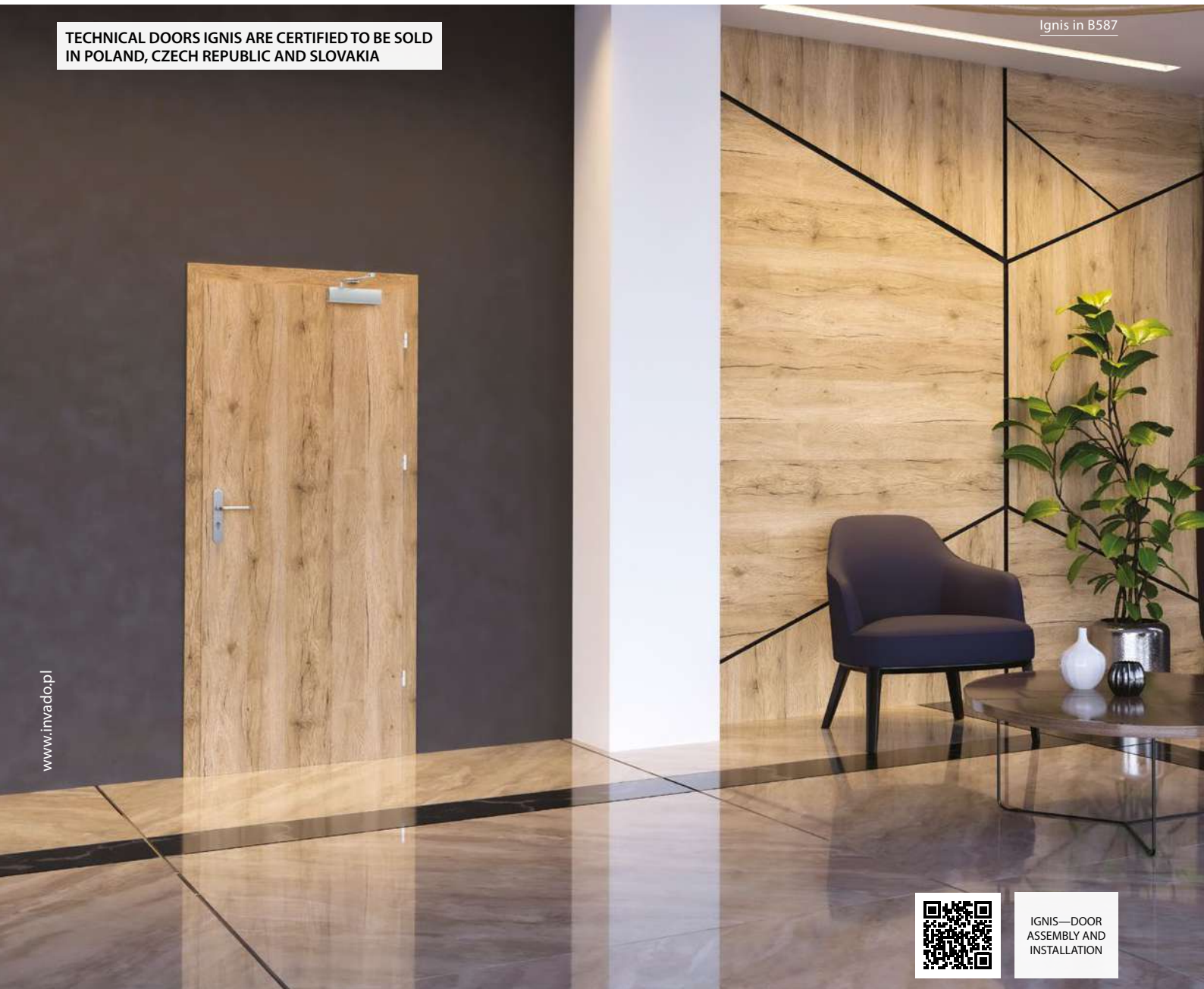

IGNIS—DOOR ASSEMBLY AND INSTALLATION

Ignis fire doors are flush, rebated, and single door leaves with fire resistance **EI₂ 30**. The door frame is made of non-flammable chipboard. The door leaf and the door frame can be installed in a firm fixing structure with minimal thickness 115 mm and minimal density 575 kg/m³, according to **PN-EN 13501-2:2016-07**. It is acceptable to mount the object in a structure that consists of:

- pillar profiles with nominal density from 40 to 55 mm,
- a type F plasterboard on each side, each 12.5 mm thick,
- mineral wool 40-50 mm thick and with density 30-60 kg/m³.

DOOR LEAVES OPTIONS



DECORS

ENDURO **

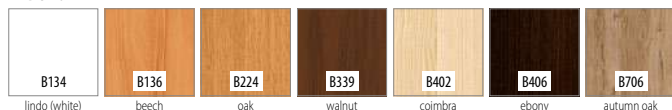

ENDURO 3D **



HORIZONTAL

ENDURO PLUS **



ECO-VENEER FORTE ***

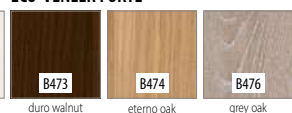

ECO-VENEER CPL ***





CONSTRUCTION

- 1** frame: laminated pinewood
- 2** filling: mineral wool
- 3** frame with filling is covered with HDF boards on both sides
- 4** door leaf covered with ENDURO foil or ECO-VENEER
 - door leaf thickness: 40 mm
 - cut edges (90°) of the door leaf (more info on p. 122)
 - width of single doors: "60"- "100"

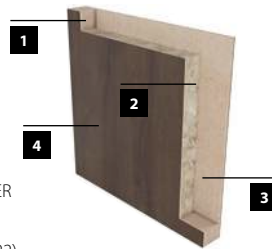

Fire doors should be a subject of technical inspections and maintenance operations in accordance with the rules set out in the applicable standards and regulations on fire-resistance doors. Technical and maintenance inspections should be carried out at least once a year.

ADDITIONAL OPTIONS

- door leaf width "100"

STANDARD EQUIPMENT

- set of intumescent seals
- latch-bolt lock
- 3 screw-in pivot hinges

DIMENSIONS

	"60"	"70"	"80"	"90"	"100" (PL)
s1 door leaf width	644	744	844	944	1044
s2 width of the wall opening	696	796	896	996	1096
s3 outer width of the door frame	666	766	866	966	1066
s4 internal width of the door frame	600	700	800	900	1000
s5 width of the door frame with architraves	744	844	944	1044	1144
h1 door leaf height	2042 (PL) / 1987 (CZ-SK)				
h2 internal height of the door frame	2062 (PL) / 2007 (CZ-SK)				
h3 outer height of the door frame	2047 (PL) / 1992 (CZ-SK)				
h4 internal height of the door frame	2025 (PL) / 1970 (CZ-SK)				
h5 height of the door frame with architraves	2097 (PL) / 2042 (CZ-SK)				

ONLY SOLD TOGETHER WITH

- cylinder lock insert
- self-closer
- UNO door handle



DEDICATED DOOR FRAMES

IGNIS LEAVES ARE SOLD ONLY WITH THE ORS1/E WOODEN DOOR FRAME—adjustable, made of non-flammable chipboard

symbol	B	C	D	E	F	G	H	I
wall thickness	100-119	120-139	140-159	160-179	180-199	200-219	220-239	240-259
symbol	J	K	L	M	N	O	P	
wall thickness	260-279	280-299	300-319	320-339	340-359	360-379	380-399	

TECHNICAL DOORS GUARDIA ARE CERTIFIED TO BE SOLD IN POLAND, RUSSIA, BELARUS, KAZAKHSTAN AND GEORGIA



www.invado.pl

APPLICATION:

Halspan system doors are intended for use in residential and public buildings as interior doors to the extent resulting from their performance characteristics set out in point 3 of the National Technical Assessment ITB-KOT-2018/0407, 1st edition. The doors have a **NATIONAL CERTIFICATE OF STABLE PERFORMANCE No. AC 158-UWB-W1355**.

Acoustic insulation index for GUARDIA EI₂30 i EI₂60:

Rw=32 db—Single door leaves EI₂30 and EI₂60

Rw=32 db—Double door leaf EI₂60

Rw=27 db—Double door leaf EI₂30

Fire resistance: EI₂30 (30 min), EI₂60 (60 min)

DOOR LEAVES OPTIONS

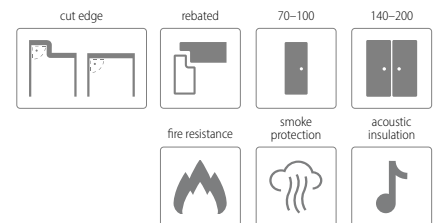

DECORS

ENDURO **

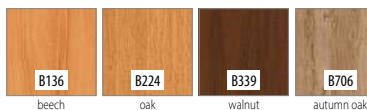

VERTICAL + HORIZONTAL

ENDURO 3D **



HORIZONTAL

ENDURO PLUS **



ECO-VENEER FORTE ***



ECO-VENEER CPL ***





Fire doors should be a subject of technical inspections and maintenance operations in accordance with the rules set out in the applicable standards and regulations on fire-resistance doors. Technical and maintenance inspections should be carried out at least once a year.

The doorset is supplied with:

- a cylinder insert according to requirements of PN-EN 1303:2015-07,
- a self-closer according to requirements of PN-EN 1154:1999 / AC: 2010P,
- a complete door handle according to requirements of PN-EN 1906:2012,
- a closing sequence controller according to requirements of PN-EN 1158:1999 / AC: 2006P (for double doors only).

NOTE: the seller is obligated to sell technical doors equipped with above elements (at extra charge)



CONSTRUCTION

- 1 coating: finger joint pinewood
- 2 filling: fireproof chipboard
- 3 frame with filling is covered with HDF boards on both sides
- 4 door leaf covered with ENDURO foil or ECO-VENEER
 - door leaf thickness: E₁ 30—50 mm / E₂ 60—60 mm
 - cut edges (90°) of the door leaf (more info on p. 122)
 - width of single doors: "70"—"100"
 - width of double doors: "140"—"200"

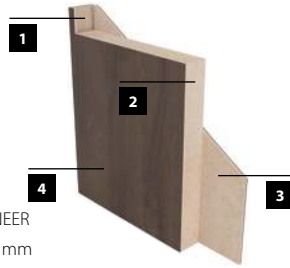

ADDITIONAL OPTIONS

- viewfinder
- smoke protection
- set of 8 mounting screws with expansion sleeves in sizes 10/152 for brick walls

STANDARD EQUIPMENT

- cylinder lock insert
- 4 hinges with regulation
- intumescent seals
- automatic bottom door seal

NOTE: automatic bottom door seal is not applicable for doors with fixed threshold

ONLY SOLD TOGETHER WITH

- cylinder lock
- UNO door handle
- door closer meeting the requirements of PN-EN 1154:1999/AC:2010P (single door)
- closing sequence controller (double door)
- TS5000 door closer meeting the requirements of PN-EN 1154:1999/AC:2010P (single door with smoke protection)

NOTE: the seller's obligation is to sell technical doors equipped with the above elements

DIMENSIONS

		single door (mm)				double door* (mm)						
		"70"	"80"	"90"**	"100"	"140"	"150"	"160"	"170"	"180"	"190"	"200"
s1	door leaf width	748	848	964	1048	1487	1587	1687	1787	1887	1987	2087
s2	width of the wall opening	856	956	1072	1156	1595	1695	1795	1895	1995	2095	2195
s3	outer width of the door frame	826	926	1042	1126	1565	1665	1765	1865	1965	2065	2165
s4	internal width of the door frame	706	806	922	1006	1445	1545	1645	1745	1845	1945	2045
h1	door leaf height	2040				2040						
h2	internal height of the door frame	2100				2100						
h3	outer height of the door frame	2084				2084						
h4	internal height of the door frame	2024				2024						

* Internal width of the door frame for double door 90+90 after opening the active door leaf at an angle of 90° is at least 900 mm, so the passive door leaf is narrower. The door set is asymmetric regarding widths of both door leaves.

** Internal width of the door frame after opening the door leaf at an angle of 90° is at least 900 mm

DEDICATED DOOR FRAME



[KOBB] block door frame 124 x 60 mm made of finger-joint pinewood

standard—no extra charge

ADDITIONAL OPTIONS AT EXTRA CHARGE FOR BLOCK DOOR FRAME

- covering profile (architrave LO1)—"70"—"100"
- quadrant LC1—"70"—"100"
- angle architrave
- enlarging element—100 mm, 200 mm, 300 mm

DIMENSIONS OF REBATED, NON-REBATED AND SLIDING DOORS

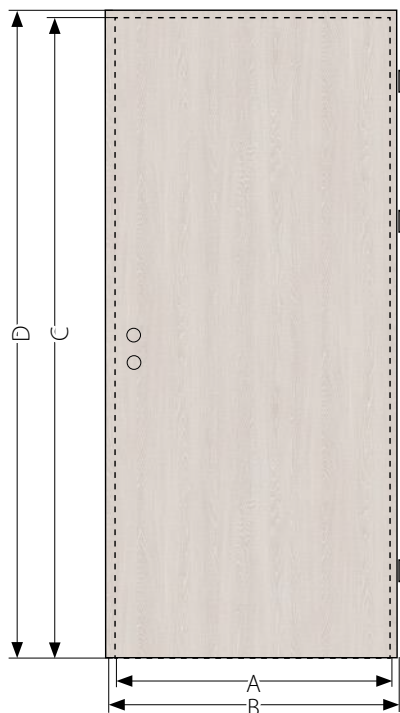

	"60"	"70"	"80"	"90"	"100"
A	618	718	818	918	1018
B	644	744	844	944	1044
C	2027 (PL) / 1975 (CZ-SK)				
D	2040 (PL) / 1988 (CZ-SK)				

Dimensions **A** and **C** are outer dimensions of non-rebated doors;
Dimensions **B** and **D** are outer dimensions of rebated doors and doors prepared for sliding systems.

A REBATE AND A COUNTER-REBATE IN DOUBLE DOOR LEAVES

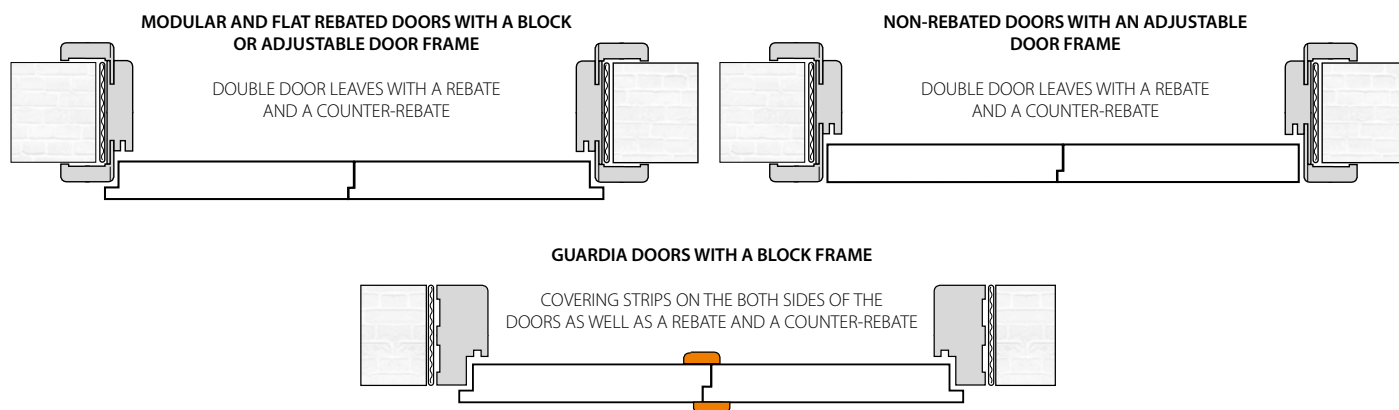

ROUNDED VERTICAL AND UPPER EDGES IN DOOR LEAVES

DOORS	SWING		SLIDING SYSTEMS	EDGE FROM THE CONTACT SIDE OF DOUBLE DOOR
	REBATED	NON-REBATED		
MODULAR DOORS	YES	YES	YES	YES
FLAT DOORS	YES		NO	NO
FLAT DOORS (MODERN AND OPTIMO LINE)	NO	NO	NO	NO
FOLDING DOORS	YES*			
EGIDA	NO			
GUARDIA	NO			NO
IGNIS	NO			

* OUTER VERTICAL EDGES ONLY.

VENTILATION

According to the norm, the door to the bathroom, shower, and separate WC should open outwards, have a passage width of at least 0.8 m and height of 2 m, and have ventilation holes for the air supply in the bottom of the door with total ventilation area of at least 0.022 m². The total ventilation area is the sum of the gap under the door (standard 7 mm) and additional solutions that increase the total net ventilation area such as ventilation sleeves, ventilation undercut, and ventilation grid. The use of a ventilation grid ensures the correct ventilation area for all door widths, while using the sleeve and/or undercut the increased gap between the door and the floor should be used to meet the required regulations. If the regulations mentioned above must be obliged, the clients must trim the door on their own.



VENTILATION UNDERCUT
(visualization for door leaf width "80")



METAL VENTILATION SLEEVES, SQUARE
(chrome, nickel)



VENTILATION SLEEVES
(visualization for door leaf width "80")



METAL VENTILATION SLEEVES, ROUND
(chrome, golden)



VENTILATION GRID
(visualization for door leaf width "80")



PVC VENTILATION SLEEVES
(variety of colours)



RECUPERATION
(visualization for door leaf width "80")



VENTILATION GRID
(Norma Decor, variety of colours)

door width	number of ventilation sleeves	door leaf with metal ventilation sleeves	door leaf with PVC ventilation sleeves for foiled doors	door leaf with PVC ventilation sleeves for modular doors	total ventilation area: ventilation undercut and the gap under the door (7 mm) [m ²]	total ventilation area: ventilation grid and the gap under the door (7 mm) [m ²]
		total ventilation area: ventilation sleeves and the gap under the door (7 mm) [m ²]				
"60"	3	0.0069	0.0062	0.0056	0.00835	> 0.022
"70"	4	0.0085	0.0075	0.0067	0.01085	
"80"	5	0.0101	0.0089	0.0079	0.01335	
"90"	6	0.0117	0.0103	0.0090	0.01585	
"100"	6	0.0124	0.0110	0.0097	0.01835	

NOTE: THE D'ARTAGNAN DOOR LEAVES CANNOT BE USED WITH VENTILATION SLEEVES, UNDERCUTS AND GRIDS. THE SLIDING LEAVES MEET THE VENTILATION REQUIREMENT DUE TO THE SYSTEM CONSTRUCTION. INVADO DOES NOT MAKE SEVERAL VENTILATION SOLUTIONS AT THE SAME TIME.

GUIDELINES FOR BUILDINGS EQUIPPED WITH A RECUPERATION SYSTEM

To ensure adequate airflow from the living areas to the corridor, sanitary, and auxiliary rooms, it is recommended that all internal doors should have a gap at the bottom. The gap area in doors in living and auxiliary rooms should be at least 80 cm² (INVADO doors with an undercut fully meet this requirement). The size of the ventilation gap in doors in sanitary rooms should be 200 cm².

DOOR FRAMES



Block door frame

FOR REBATED DOORS [OB3]



CONSTRUCTION

- MDF board
- foiling—all decors available in the INVADO offer
- cross-section: 90 x 44 mm

DOOR FRAME FOR DOOR LEAVES IN WIDTH

- width of single doors "60" to "100"
- width of double doors "120" to "200"

OPTIONS AT EXTRA CHARGE FOR BLOCK DOOR FRAMES

- flat architrave LO1 60 x 10 mm "60"–"100"
- flat architrave LO7 80 x 16 mm "60"–"100"
- quadrant LC1 (single doors) or LC2 (double doors)
- door frames with sidelights and transoms (without glass) with circumference up to 5 l.m
- door frames for double doors
- additional hinge in door frame "60"–"80"

APPLICATION OF QUADRANT LC2 AND ARCHITRAVE LO1, AND THEIR COVERING SURFACES

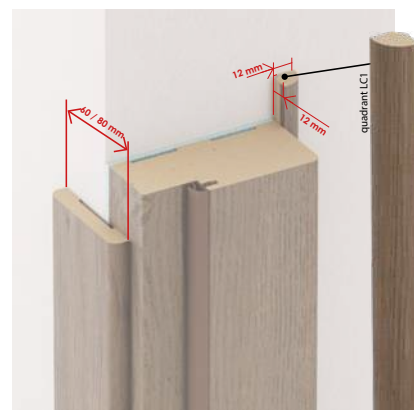

COVERING TRIMS (LO1) AND QUADRANT (LC1) CAN BE APPLIED TO A BLOCK DOOR FRAME FOR DOOR LEAVES IN WIDTHS "60"–"90". IN CASE OF DOOR LEAVES IN WIDTH "100", YOU HAVE TO ORDER DOUBLE COVERING TRIM (LO2) OR DOUBLE QUADRANT (LC2).

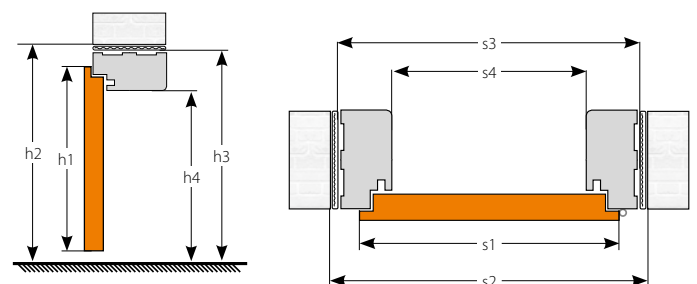

DIMENSIONS

		width of single doors (mm)					width of double doors (mm)—ATTENTION: CHANGE OF DIMENSIONS								
		"60"	"70"	"80"	"90"	"100"	"120"	"130"	"140"	"150"	"160"	"170"	"180"	"190"	"200"
s1	door leaf width	644	744	844	944	1044	1278	1378	1478	1578	1678	1778	1878	1978	2078
s2	width of the wall opening	718	818	918	1018	1118	1354	1454	1554	1654	1754	1854	1954	2054	2154
s3	outer width of the door frame	688	788	888	988	1088	1324	1424	1524	1624	1724	1824	1924	2024	2124
s4	internal width of the door frame	600	700	800	900	1000	1236	1336	1436	1536	1636	1736	1836	1936	2036
h1	door leaf height	2040 (PL) / 1988 (CZ-SK)													
h2	height of the wall opening	2084 (PL) / 2030 (CZ-SK)													
h3	outer height of the door frame	2069 (PL) / 2015 (CZ-SK)													
h4	internal height of the door frame	2025 (PL) / 1971 (CZ-SK)													

Adjustable door frame

FOR REBATED DOORS [ORS1 / ORS8]

www.invado.pl

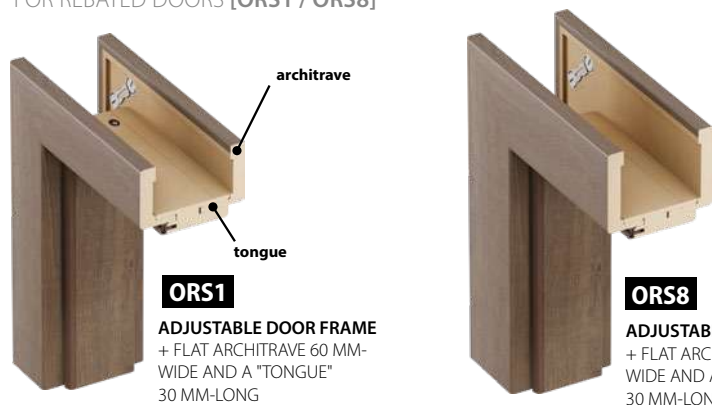

ORS1

ADJUSTABLE DOOR FRAME
+ FLAT ARCHITRAVE 60 MM-
WIDE AND A "TONGUE"
30 MM-LONG

ORS8

ADJUSTABLE DOOR FRAME
+ FLAT ARCHITRAVE 80 MM-
WIDE AND A "TONGUE"
30 MM-LONG

ADJUSTABLE DOOR
FRAME INSTALLATION



HINGE



CAPS FOR HINGES

CONSTRUCTION

- MDF board
- foiling—all decors available in the INVADO offer
- the standard adjustable door frame consists of a central element plus 2 sets of angle architraves joined at 45°. A standard angle architrave consists of a flat architrave 60 mm-wide and a "tongue" 30 mm-long. It is possible to separately order a set of angle architraves 80 mm-wide and/or a set of angle architraves 80 mm-wide with a "tongue" 50 mm-long (see table of options at extra charge).

DOOR FRAME FOR DOOR LEAVES IN WIDTH

- width of single doors "60" to "100"
- width of double doors "120" to "200"

OPTIONS AT EXTRA CHARGE

- door frames with sidelights and transoms (without glass) with circumference up to 5 l.m
- door frames for double doors
- additional hinge in door frame "60"–"80"
- standard angle architrave (a "tongue" 30 mm-long, an architrave 60 or 80 mm-wide)
- angle architrave with longer "tongue" (a "tongue" 50 mm-long, an architrave 60 or 80 mm-wide)
- wall framing ("blind door frame")

RANGES OF WALL THICKNESS COVERING



Door frame for
wall thickness
from 360 mm

DOOR FRAME
WIDTH
MODIFICATION



The adjustable door frame is made in dimensions adjustable to the wall thickness in steps of 20 mm. The minimum wall thickness is 75 mm

NOTE: due to special mills, there is a possibility to trim the frame and reduce the wall thickness coverage by 15 mm. Door frame for wall thickness greater than 360 mm consists of at least two connected components.

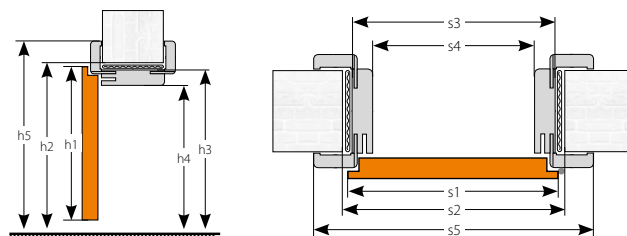

DIMENSIONS

	width of single doors (mm)					width of double doors (mm)—ATTENTION: CHANGE OF DIMENSIONS										
	"60"	"70"	"80"	"90"	"100"	"120"	"130"	"140"	"150"	"160"	"170"	"180"	"190"	"200"		
s1	door leaf width	644	744	844	944	1044	1278	1378	1478	1578	1678	1778	1878	1978	2078	
s2	width of the wall opening	674	774	874	974	1074	1310	1410	1510	1610	1710	1810	1910	2010	2110	
s3	outer width of the door frame	644	744	844	944	1044	1280	1380	1480	1580	1680	1780	1880	1980	2080	
s4	internal width of the door frame	600	700	800	900	1000	1236	1336	1436	1536	1636	1736	1836	1936	2036	
s5	width of the door frame with architraves	60 mm [ORS1]	744	844	944	1044	1144	1380	1480	1580	1680	1780	1880	1980	2080	2180
		80 mm [ORS8]	784	884	984	1084	1184	1420	1520	1620	1720	1820	1920	2020	2120	2220
h1	door leaf height	2040 (PL) / 1988 (CZ-SK)														
h2	height of wall opening	2062 (PL) / 2008 (CZ-SK)														
h3	outer height of the door frame	2047 (PL) / 1993 (CZ-SK)														
h4	internal height of the door frame	2025 (PL) / 1971 (CZ-SK)														
h5	height of the door frame with architraves	60 mm [ORS1]	2097 (PL) / 2043 (CZ-SK)													
		80 mm [ORS8]	2117 (PL) / 2063 (CZ-SK)													

NOMINAL COVERAGE OF THE WALL

*It is possible to order adjustable door frame thicker than 499 mm—for this purpose please contact with INVADO's commercial department

symbol	A	B	C	D	E	F	G	H	I	J	
wall thickness	75-94	95-114	120-139	140-159	160-179	180-199	200-219	220-239	240-259	260-279	
symbol	K	L	M	N	O	P	Q	R	S	T	U
wall thickness	280-299	300-319	320-339	340-359	360-379	380-399	400-419	420-439	440-459	460-479	480-499*

Adjustable door frame

FOR NON-REBATED DOORS [ORS7 / ORS10]



CONSTRUCTION

- MDF board
- foiling—all decors available in the INVADO offer
- the standard adjustable door frame consists of a central element plus 2 sets of angle architraves joined at 45° (ORS7 i ORS10) or 90° (ORS4). A standard angle architrave consists of a flat architrave 60 mm-wide and a "tongue" 30 mm-long. It is possible to separately order a set of angle architraves 80 mm-wide and/or a set of angle architraves 80 mm-wide with a "tongue" 50 mm-long (see table of options at extra charge).

DOOR FRAME FOR DOOR LEAVES IN WIDTH

- width of single doors "60" to "100"
- width of double doors "120" to "200"

OPTIONS AT EXTRA CHARGE

- door frames with sidelights and transoms (without glass) with circumference up to 5 l.m
- door frames for double doors
- additional hinge in door frame
- standard angle architrave (a "tongue" 30 mm-long, an architrave 60 or 80 mm-wide)
- angle architrave with longer "tongue" (a "tongue" 50 mm-long, an architrave 60 or 80 mm-wide)

RANGES OF WALL THICKNESS COVERING



Door frame for wall thickness from 360 mm

DOOR FRAME WIDTH MODIFICATION



The adjustable door frame is made in dimensions adjustable to the wall thickness in steps of 20 mm. The minimum wall thickness is 75 mm.

NOTE: for wall thickness between 75–85, it is required to use wall frame A(75–94). In this case, the angle architrave should be trimmed where the mills are located—otherwise, the door frame won't be properly aligned with the wall. Door frames for a wall thickness greater than 360 mm consist of at least two connected elements.

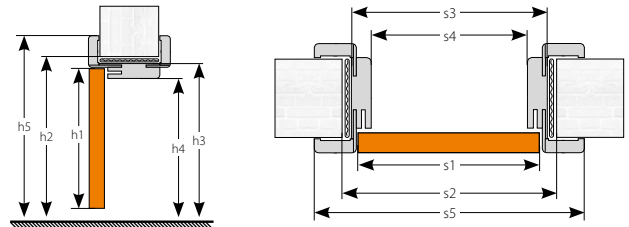

DIMENSIONS

		width of single doors (mm)					width of double doors (mm)									
		"60"	"70"	"80"	"90"	"100"	"120"	"130"	"140"	"150"	"160"	"170"	"180"	"190"	"200"	
s1	door leaf width	618	718	818	918	1018	1239	1339	1439	1539	1639	1739	1839	1939	2039	
s2	width of the wall opening	674	774	874	974	1074	1294	1394	1494	1594	1694	1794	1894	1994	2094	
s3	outer width of the door frame	644	744	844	944	1044	1264	1364	1464	1564	1664	1764	1864	1964	2064	
s4	internal width of the door frame	600	700	800	900	1000	1220	1320	1420	1520	1620	1720	1820	1920	2020	
s5	width of the door frame with architraves	60 mm [ORS7]	744	844	944	1044	1144	1364	1464	1564	1664	1764	1864	1964	2064	2164
		80 mm [ORS10]	784	884	984	1084	1184	1404	1504	1604	1704	1804	1904	2004	2104	2204
		80 mm [ORS4]														
h1	door leaf height	2027 (PL) / 1975 (CZ-SK)														
h2	height of wall opening	2062 (PL) / 2008 (CZ-SK)														
h3	outer height of the door frame	2047 (PL) / 1993 (CZ-SK)														
h4	internal height of the door frame	2025 (PL) / 1971 (CZ-SK)														
h5	height of the door frame with architraves	60 mm [ORS7]	2097 (PL) / 2043 (CZ-SK)													
		80 mm [ORS10]	2117 (PL) / 2063 (CZ-SK)													
		80 mm [ORS4]														

NOMINAL COVERAGE OF THE WALL

*It is possible to order adjustable door frame thicker than 499 mm—for this purpose please contact with INVADO's commercial department

symbol	A	B	C	D	E	F	G	H	I	J	
wall thickness	75-94	95-114	120-139	140-159	160-179	180-199	200-219	220-239	240-259	260-279	
symbol	K	L	M	N	O	P	Q	R	S	T	U
wall thickness	280-299	300-319	320-339	340-359	360-379	380-399	400-419	420-439	440-459	460-479	480-499*

Metal door frames

[FD 11 / FD 12 / FD 14 / FD 61-67]

www.invado.pl

METAL DOOR FRAME (BIG) [FD 11 / FD 12]



Covering assembly:

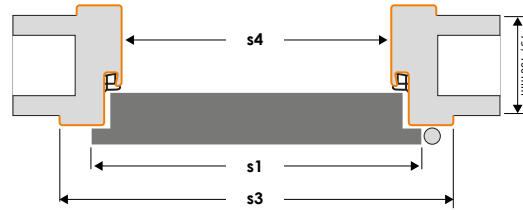

Corner assembly:

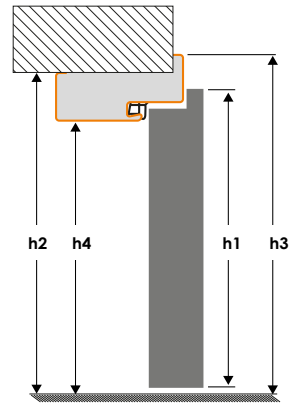
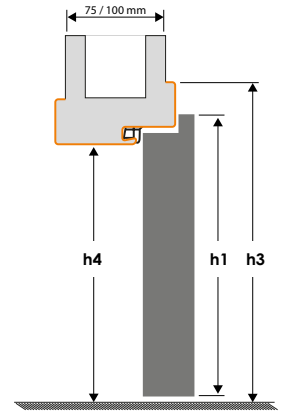
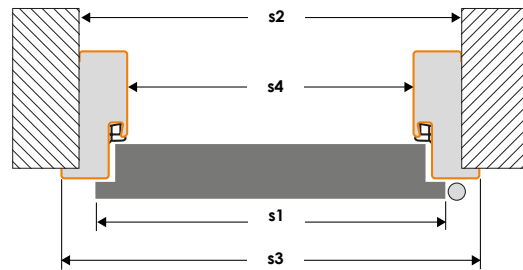

CONSTRUCTION

- welded frame
- ungalvanized plate with a thickness of 1.2 mm
- powder-coated frame in a choice of standard RAL colours
- 2 hinges in colour white zinc and a seal included
- universal mounting brackets for brick walls and plasterboard walls

DOOR FRAME FOR DOOR LEAVES IN WIDTH

- width of single doors "60" to "100"
- width of double doors "120" to "200"

RANGES OF WALL THICKNESS COVERING

- door frame FD 11—75 mm
- door frame FD 12—100 mm

DIMENSIONS

	single door (mm)					double door (mm)—ATTENTION: CHANGE OF DIMENSIONS									
	"60"	"70"	"80"	"90"	"100"	"120"	"130"	"140"	"150"	"160"	"170"	"180"	"190"	"200"	
s1	door leaf width	644	744	844	944	1044	1278	1378	1478	1578	1678	1778	1878	1978	2078
s2	width of the wall opening	670	770	870	970	1070	1306	1406	1506	1606	1706	1806	1906	2006	2106
s3	outer width of the door frame	696	796	896	996	1096	1332	1432	1532	1632	1732	1832	1932	2032	2132
s4	internal width of the door frame	600	700	800	900	1000	1236	1336	1436	1536	1636	1736	1836	1936	2036
h1	door leaf height	2040													
h2	height of the wall opening	2037													
h3	outer height of the door frame	2072													
h4	internal height of the door frame	2024													

AVAILABLE RAL DECORS

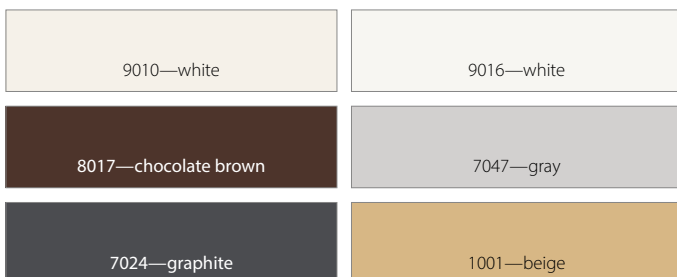

OPTIONS AT EXTRA CHARGE

- reinforcement for the self-closer
- adapted for the electric door strike

METAL DOOR FRAME (SMALL) [FD 14]

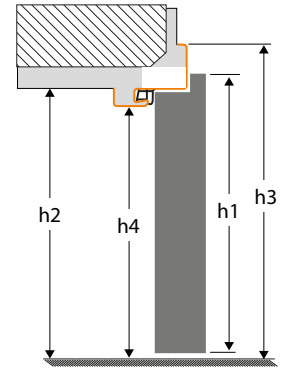
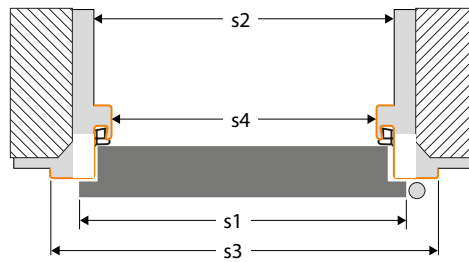

CONSTRUCTION

- welded frame
- ungalvanized plate with a thickness of 1.2 mm
- powder-coated frame in a choice of standard RAL colours
- 2 hinges in colour white zinc and a seal included
- universal mounting brackets for brick walls and plasterboard walls

DOOR FRAME FOR DOOR LEAVES IN WIDTH

- width of single doors "60" to "100"
- width of double doors "120" to "200"

DIMENSIONS

	single door (mm) (mm)					double door (mm)—ATTENTION: CHANGE OF DIMENSIONS									
	"60"	"70"	"80"	"90"	"100"	"120"	"130"	"140"	"150"	"160"	"170"	"180"	"190"	"200"	
s1	door leaf width	644	744	844	944	1044	1278	1378	1478	1578	1678	1778	1878	1978	2078
s2	width of the wall opening	661	761	861	961	1061	1297	1397	1497	1597	1697	1797	1897	1997	2097
s3	souter width of the door frame	696	796	896	996	1096	1332	1432	1532	1632	1732	1832	1932	2032	2132
s4	internal width of the door frame	600	700	800	900	1000	1236	1336	1436	1536	1636	1736	1836	1936	2036
h1	door leaf height	2040													
h2	height of the wall opening	2038													
h3	outer height of the door frame	2072													
h4	internal height of the door frame	2024													

ADJUSTABLE METAL DOOR FRAME [FD 61–67]

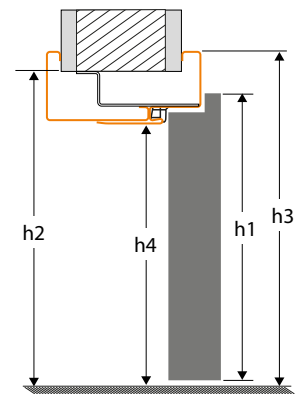
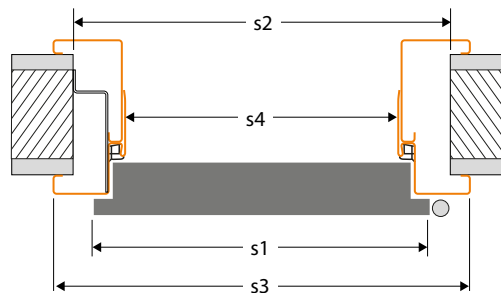

CONSTRUCTION

- 2-part frame, adjustable (adjustment range in 30 mm steps)
- ungalvanized plate with a thickness of 1.5 mm
- powder-coated frame in a choice of standard RAL colours
- 3 hinges in colour white zinc and a seal included
- universal mounting brackets for brick walls and plasterboard walls

DOOR FRAME FOR DOOR LEAVES IN WIDTH

- width of single doors "60" to "100"
- width of double doors "120" to "200"

DIMENSIONS

	single door (mm)					double door (mm)—ATTENTION: CHANGE OF DIMENSIONS									
	"60"	"70"	"80"	"90"	"100"	"120"	"130"	"140"	"150"	"160"	"170"	"180"	"190"	"200"	
s1	door leaf width	644	744	844	944	1044	1278	1378	1478	1578	1678	1778	1878	1978	2078
s2	width of the wall opening	683	783	883	983	1083	1316	1416	1516	1616	1716	1816	1916	2016	2116
s3	outer width of the door frame	716	816	916	1016	1116	1350	1450	1550	1650	1750	1850	1950	2050	2150
s4	internal width of the door frame	600	700	800	900	1000	1236	1336	1436	1536	1636	1736	1836	1936	2036
h1	door leaf height	2040													
h2	height of the wall opening	2065													
h3	outer height of the door frame	2082													
h4	internal height of the door frame	2024													



The SARA-PRO door frame introduces a brand new quality in interior decoration. Invisible to the naked eye, it makes the area lighter. Ideal for minimalist and modern interiors. Available in outer and inner versions.

Non-rebated door leaf for outer door frame and rebated door leaf for inner door frame is based on the NORMA DECOR 1 door leaf



NEW DECORS

ENDURO ••

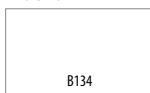

ENDURO 3D ••



ENDURO PLUS ••



NOTE: It's possible to paint the SARA-PRO door frame with a wall paint after previously coating it with a primer paint included in the package.

CPL 0,15 MM ••••

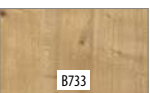
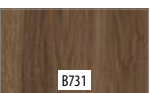
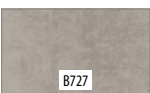
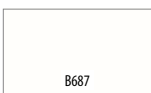
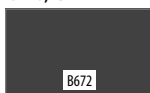

CONSTRUCTION

- the frame is made of an MDF board
- board prepared for painting and wallpapering
- filling—"honeycomb" or tubular chipboard (optionally)
- frame with filling is covered with HDF boards on both sides
- width of single doors "60"–"90"

ADDITIONAL OPTIONS

- door without a keyhole no extra charge
- ventilation undercut
- PVC ventilation sleeves
- cylinder lock insert 31/36
- filling—tubular chipboard
- automatic door bottom seal for door width "60"–"90"
- ventilation grid

STANDARD EQUIPMENT

- 2 hidden hinges
- magnetic lock for a standard key, a WC knob or a cylinder lock insert

DIMENSIONS OF A DOOR LEAF AND CONCEALED DOOR FRAME

	inner door frame (mm)				outer door frame (mm)				
	"60"	"70"	"80"	"90"	"60"	"70"	"80"	"90"	
s1	door leaf width	618	718	818	918	618	718	818	918
s2	width of the wall opening	698	798	898	998	698	798	898	998
s3	outer width of the door frame	688	788	888	988	688	788	888	988
s4	internal width of the door frame	603	703	803	903	603	703	803	903
h1	door leaf height	2027 (PL) / 1975 (CZ-SK)				2017 (PL) / 1965 (CZ-SK)			
h2	height of the wall opening	2076 (PL) / 2024 (CZ-SK)				2066 (PL) / 2014 (CZ-SK)			
h3	outer height of the door frame	2069 (PL) / 2017 (CZ-SK)				2059 (PL) / 2007 (CZ-SK)			
h4	internal height of the door frame	2027 (PL) / 1975 (CZ-SK)				2017 (PL) / 1965 (CZ-SK)			

CONCEALED DOOR FRAME SARA-PRO—INNER

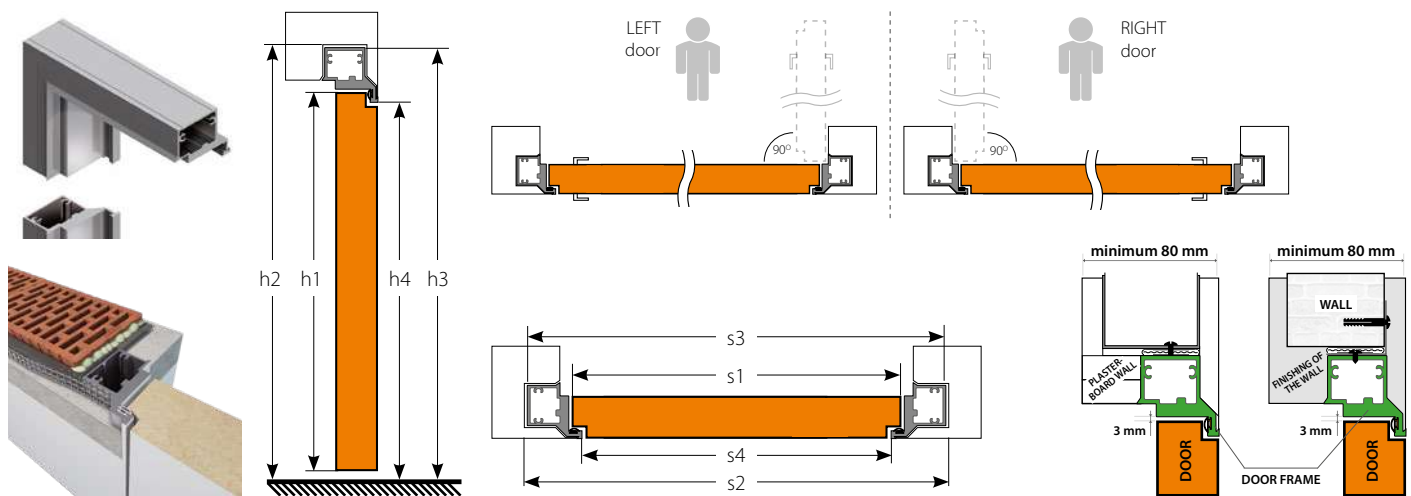

CONCEALED DOOR FRAME SARA-PRO—OUTER

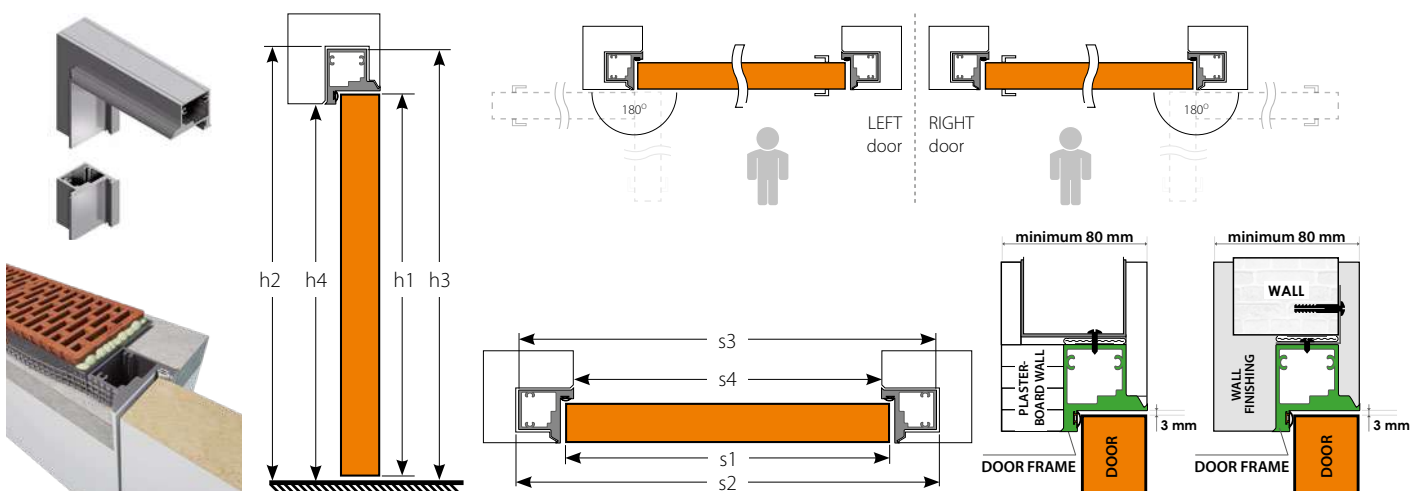

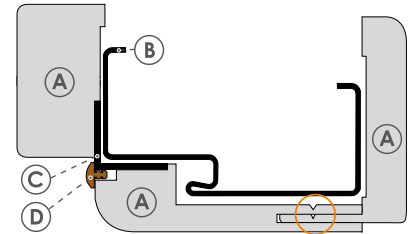

- (A) door frame housing
- (B) metal door frame
- (C) aluminium angle element
- (D) gasket

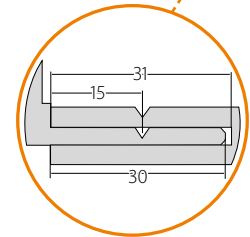

FEATURES

Metal frame housing (covering) allows the installation of new doors in the rooms where metal frames were mounted following the Polish standard (regarding dimensions) without having to remove these frames. The advantage of this solution is an easy installation with mounting foam, without dirty floors and walls, and the ability to mount standard foiled INVADO door leaves.

WIDTH OF THE DOOR FRAME FOR DOOR LEAVES

- width of single doors "60" to "90"

INTERNAL DIMENSIONS OF METAL DOOR FRAME (MM)

		"60"	"70"	"80"	"90"
s1	door leaf width	600	700	800	900
h1	door leaf height	2025 (PL) / 1975 (CZ-SK)			

RANGES OF WALL THICKNESS

- 60–94, 95–129, 130–199, 200–269

Housing system for metal door frames for walls thicker than 130 mm has an additional enlarging element.

For the range of 130–199—the enlarging element is 85 mm-wide.
For the range of 200–269—the enlarging element is 155 mm-wide.

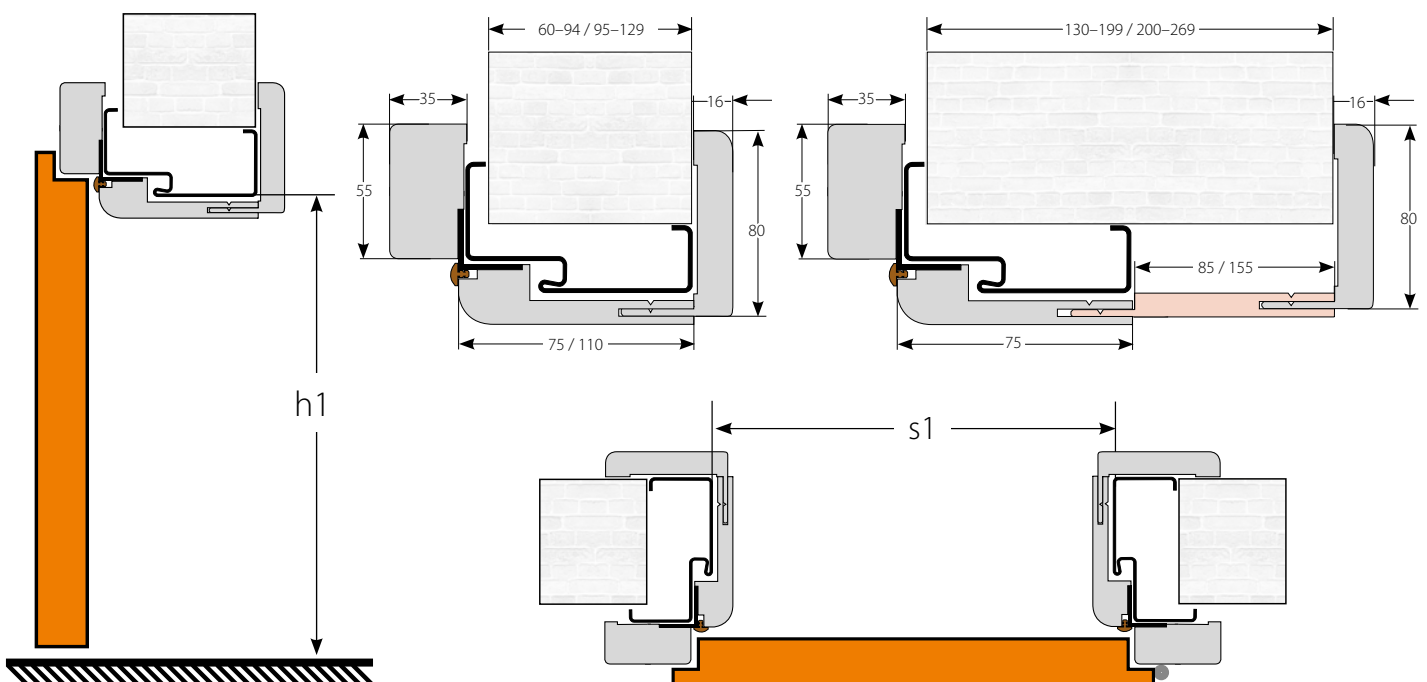

ACCESSORIES AND HANDLES



FOILED AND MODULAR DOORS



caps for hinges
(satinated chrome, chrome, black or golden)
set for 1 piece of hinge



hinge



hidden hinge
delivered with a door frame



cylinder lock insert



porthole (black or silver with satinated or transparent glass)
included in the price of the door

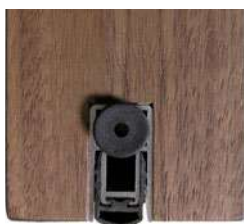

automatic bottom door seal



aluminium threshold



door seal
(black, white, gray, brown, beige)



ventilation sleeves
PVC



ventilation sleeves
metal round



ventilation sleeves
metal square



ventilation grid

OPTIMO LINE

COLOURS: WHITE, SATIN CHROME, GOLD, BLACK



magnetic lock



adjustable strike plate



hidden hinges



edge band in a different colour than the door leaf surface
(natural hamilton oak, alpine white or pure black)

surcharge for changing the colour of the fittings—set: 2 hinges + strike plate + door leaf lock

KICK AND PUSH METAL PANELS

- material: polished stainless steel
- dimensions: width matched to the door leaf, height 300 mm, thickness 0.6 mm
- ventilation sleeves—diameter: 40 mm (depending on the width of the door leaf, a different number of ventilation sleeves are used: "60"—3 sleeves / "70"—4 sleeves / "80"—5 sleeves / "90"—"100"—6 sleeves)
- ventilation undercut—height: 15 mm;
- ventilation grid—dimensions: 430 x 110 mm.



PUSH top panel with handle holes



standard KICK bottom panel



KICK bottom panel with ventilation undercut



KICK bottom panel with ventilation sleeves



KICK bottom panel with ventilation grid

NEW BLACK IRONMONGERY FOR REBATED DOORS



black pivot hinge



black lock
(key / WC / cylinder insert)



strike plate
for the block door frame



strike plate
for the adjustable door frame

SLIDING SYSTEMS



hook lock—key
hook lock—key

hook lock
WC / key



grip with folding key
and a thimble

COLOURS: CHROME, SATIN CHROME, GOLD, BLACK



grip with WC
knob and
a thimble



grip and
a thimble



strike plate



soft-close hardware
for sliding door



door seal

POCKET DOOR SLIDING SYSTEM



profiles and architraves



brush

WALL-MOUNTED SLIDING SYSTEM



rail cover



bumper

TECHNICAL DOORS



cylinder lock
(Guardia)



cylinder lock insert
(Guardia / Ignis)



cylinder lock insert with
a WILKA knob
(Egida)



automatic bottom
door seal
(Guardia / Egida)



panoramic viewfinder
(Guardia / Egida)



self-closer
(Guardia / Ignis)



intumescent seals
(Guardia)



hinge with regulation
(Guardia)



handle QUEBECK
(TYTAN / INOX) (Egida)



handle ROYAL
(INOX) (Egida)

Handles

with escutcheon for repeatable key

with escutcheon for cylinder lock insert



with escutcheon for WC lock

COLOURS:



handle **IBIZA K**
photo: black







-  white
-  black



handle **QUBIK K FIT**
photo: brushed brass



-  black
-  brushed nickel
-  glossy chrome
-  brushed brass



handle **TOPAZ**
photo: stainless steel







-  stainless steel (inox)



handle **QUANTA K FIT**
photo: glossy chrome







-  black
-  brushed nickel
-  glossy chrome
-  brushed brass



handle **SPIGOLA-QR**
photo: matt copper







-  black
-  matt chrome
-  glossy chrome
-  matt golden
-  matt copper



handle **FOSTER-BI**
photo: glossy gold



-  glossy chrome
-  matt nickel
-  white
-  black
-  glossy gold



handle **EUFORIO**
photo: black



-  black



handle **SPARK FIT**
photo: black



-  black

with escutcheon for repeatable key

with escutcheon for cylinder lock insert

with escutcheon for WC lock

COLOURS:



handle **SPARK**
photo: satinated nickel



handle **TOTAL-Q**
photo: glossy chrome



handle **ENTRA**
photo: anthracite/chrome

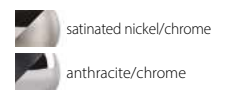

handle **FLIP**
photo: anthracite/chrome

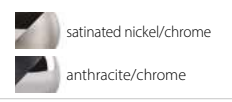

handle **GIUSSY**
photo: nickel/chrome

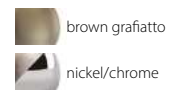

handle **INVADO**
photo: nickel/chrome



handle **PRESTO**
photo: nickel/chrome



handle **UNO-R**
photo: stainless steel

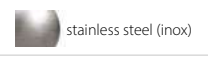

handle **UNO**
photo: stainless steel

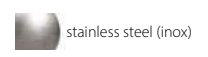



PRESTIGE
SKIRTINGS
INSTALLATION

MODEL P124



MODEL P125

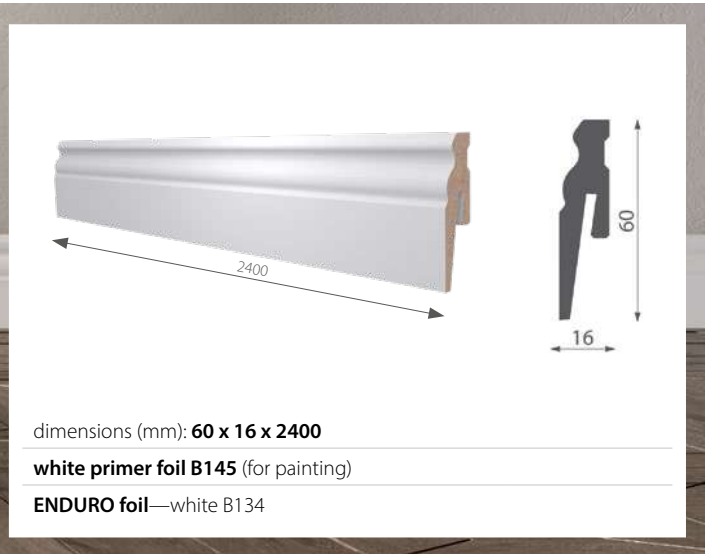

MODEL P127



ADDITIONAL OPTIONS

- finishing element 20 x 20 x 120 mm
- clips—30 pcs/package

NOTE: The length of a single skirting is 2.4 m. The skirtings are packed and sold in sets of 5. The prices below are for 1 pc.

clips



finishing element



MODEL P129 / P402 / P403



white primer foil B145 (for painting)

ENDURO foil: profiles P402 and P403 available only in the B134 decor

ECO-VENEER

MODEL P130



dimensions (mm): **100 x 16 x 2400**

white primer foil B145 (for painting)

ENDURO foil—white B134

MODEL P132



dimensions (mm): **100 x 16 x 2400**

white primer foil B145 (for painting)

ENDURO foil—white B134

INVADO Ltd.
Dzielna st. Leśna 2
42-793 Ciasna, Poland

e-mail: biuro@invado.pl
tel. +48 34 351 05 40



ONLINE CATALOGUE





Export
MANAGERS



Export + 48 34 35 10 550
DIRECTOR + 48 508 052 407

 + 48 34 35 13 882
+ 48 513 120 072

 + 48 34 35 10 549
+ 48 509 680 283

 + 48 34 35 13 843
+ 48 518 821 019

 + 48 34 35 13 878
+ 48 503 186 762

A company of Arbonia Group

ARBONIA 
Doors

All information in the catalogue do not constitute an offer within the meaning of the Civil Code and are published for informational purposes only. Manufacturer reserves the right to make changes.

Note! Due to the printing technique the colors of the products presented in the catalogue may differ from the original. All rights reserved. Copying and publication of this catalogue on web sites and in other media without the written consent from INVADO Sp. z o.o. is prohibited.

Distributor's stamp:

