

edition 12



*"If you  
can  
Dream it...*

### **With your needs in mind.**

Nowadays we live in a constant rush, trying to find peace, beauty, and a safe refuge at home and in the places where we live. A sense of security and harmony definitely improves everyday quality of life. INVADO understands and respects these needs. Being one of the most rapidly developing manufacturers of door joinery and skirting boards in Poland, we do our best to give you products that meet your needs, with high, individual aesthetics and the best possible functional features. INVADO is also a leading supplier of components for the furniture industry—its market position is being built on the basis of over thirty years of experience and continuous investment in technology, people and quality improvement.



**INVADO**<sup>®</sup>  
doors

*...you can  
Do it*

## CERTIFICATES AND AWARDS:



### Quality above all

INVADO continually strives to ensure optimal quality of its products, taking into account our users' personal needs. Quality is paramount—it is the basic issue in the design phase and remains the common denominator for all production processes. ISO 9001 certificate provides such an approach to the issue of quality. All INVADO products meet European standards. The high level of products and services next to the price and delivery time is the Company's primary objective, ensuring its perception as a trusted partner.

### INVADO Technology

Production of door leaves and door frames is the strongest point of our INVADO offer, therefore the implementation of innovative production technology of foiled doors (INVADO Technology) became a major breakthrough in the Company's activity. The most distinct feature of this technology is foiling surfaces without connecting foil on rebate edges. Because of this method the edge of a door leaf looks aesthetically clean and is also more resistant to damage. It's very unlikely to break off the foil because it ends in the inner corner of the rebate—invisible to the eye. „Technology of foiling flat doors in the mass production system” is in use since 2007 when it comes to all foiled doors. In addition—off-rebate foiling makes the INVADO doors the only ones on the market to have rounded edges, safe for both adults and children's hands. Nowadays, thanks to the innovative method of doors' production, INVADO is among the most technologically advanced companies in Europe.

### Hygienic certificates

Certifications aim to prevent materials and products hazardous to health and life of its users to be introduced to the general use or limit the allowable scope and method of their application for the elimination of health risks. All INVADO products have hygienic certificates:

- interior door frames in natural veneer No. 48/322/49/2017
- interior door frames in artificial veneer No. 441/322/451/2017
- interior door leaves in natural veneer No. 46/322/47/2017
- interior door leaves in artificial veneer or flat lacquered No. 348/322/353/2020
- skirting boards in natural veneer No. 47/322/48/2017
- skirting boards in artificial veneer No. 256/322/261/2019

### Technical Approvals and National Technical Assessments:

Technical Approvals (until the end of their term) and National Technical Assessments, issued by Building Research Institute, are decisions to grant use of building materials and products. In accordance with the Construction Products Act of 16 April 2004, as amended (unified text: Journal of Laws of 2016, item 1570), the products to which the Technical Approvals and National Technical Assessments relate, may be placed on the market and can be used in construction. INVADO Company assessed and verified the constancy of performance, made a national declaration of performance and labeled the products with a construction mark in accordance with applicable regulations. INVADO's Technical Approvals and National Technical Assessments:

- Interior flat and glass doors—ITB-KOT-2017/0313 edition 1;
- Modular interior doors—ITB-KOT-2017/0003 edition 1;
- Folding, swinging and sliding interior doors—ITB-KOT-2018/0296 edition 1;
- Adjustable door frames for interior doors—ITB-KOT-2019/1221 edition 1;
- Block door frames for interior doors OB3 type P—ITB-KOT-2017/0312 edition 1;
- Door frames SARA-PRO for interior doors—ITB-KOT-2019/1076 edition 1;
- Metal door frame—ITB-KOT-2021/2091 edition 1;
- Housing system for metal frames—ITB-KOT-2019/1221 edition 1.



### CERTIFICATE RESOURCES SAVED

INVADO has obtained the international certificate in waste management and recycling issued by INTERSEROH zero waste solutions.



### GOOD BRAND 2019 AND 2021

An independent group of experts has confirmed that the products signed with the INVADO logo can be described using such words as: quality, trust and reputation. These three guidelines decide which selected brands are among the renowned brands. We are proud and grateful for that and at the same time we would like to thank our Customers for trusting us by choosing INVADO doors for your dream interiors, our Business Partners for the fruitful cooperation, recommendation, and support, and all our INVADO employees for building together a good brand at every stage of its creation.



### CONSUMER'S LAUREL

INVADO brand has been recognized by Polish consumers and honored with the prestigious Consumer's Laurel emblem.



### VOC

The VOC certification tests the emission of volatile organic compounds released from the facility and, depending on the results obtained, the tested sample is assigned a class, ranging from A+ (best) and C (worst). The possession of the VOC certificate confirms that the product

does not release harmful for health substances inside the house, such as formaldehyde and benzene, a carcinogenic elements that unfortunately are often contained in paints, and materials used on windows.



### ISO 9001

The INVADO Company applies to the Quality Management System and fulfills requirements of: PN-EN ISO 9001 in scope of: designing, production and sale of furniture components and finishing profiles, interior doors made of wood and woodbased materials and technical doors.



### FSC®

Control of Product Origin and environmental protection are the leading elements of INVADO's development strategy. This is confirmed by an international certificate issued by the Forest Stewardship Council® and obtained by the company in 2007.

Ask for FSC® certified products in our range.

The mark of responsible forestry



**MONTHS OF WARRANTY ON INVADO DOORS**

# TABLE OF CONTENTS

GOOD TO KNOW

6-7 AVAILABLE DECORS

8-9 AVAILABLE GLASS

9



## COLLECTION OF MODULAR DOORS

10-51

							
collection <b>CORATO</b>	12 collection <b>ARTANO</b>	14 collection <b>AVERSA</b>	14 collection <b>MIRROR</b>	16 collection <b>LAGO</b>	18 collection <b>PASARO</b>	20 collection <b>VINADIO</b>	22 collection <b>FOSSANO</b>
							
collection <b>IMPERIA</b>	26 collection <b>DESTINO UNICO</b>	28 collection <b>LIVATA</b>	30 collection <b>VERSANO</b>	32 collection <b>NOGARO</b>	34 collection <b>TAMPARO</b>	36 collection <b>LINEA FORTE</b>	38 collection <b>CAPENA INSERTO</b>
							
collection <b>MARTINA</b>	42 collection <b>DOMINO</b>	44 collection <b>BIANCO</b>	46 collection <b>LARINA</b>	48 collection <b>D'ARTAGNAN</b>	50		

## COLLECTION OF FOILED DOORS

52-79



## COLLECTION OF FOLDING DOORS



collection  
**NORMA DECOR AND LIBRA** 80

## SLIDING SYSTEMS



type of system  
**POCKET DOOR SLIDING SYSTEM** 82  
**WALL-MOUNTED SLIDING SYSTEM** 84

## TECHNICAL INFORMATIONS



86

## DOOR FRAMES



<b>BLOCK DOOR FRAME</b>	87
<b>ADJUSTABLE DOOR FRAME</b>	88
<b>ADJUSTABLE DOOR FRAME FOR NON-REBATED DOORS</b>	89
<b>METAL FRAMES</b>	90-91
<b>CONCEALED DOOR FRAME SARA-PRO</b>	92-93
<b>HOUSING SYSTEM FOR METAL FRAME</b>	94

## HANDLES



96-97

## ACCESSORIES

95



## SKIRTING BOARDS

98-99



## FOILED AND MODULAR DOORS:

### FOILED DOORS

Visually, **foiled doors** are lighter than modular ones, which is combined with their stability. Construction: frame made of MDF board or finger joint pinewood. Filling: "honeycomb" or tubular chipboard, which is charged extra. The frame with filling is covered with a 3 mm-thick HDF board from both sides and wrapped with a decorative foil. For installation of filling elements in these doors, the glazing bars of different profiles are used.



### MODULAR DOORS

Construction of **modular doors**: 2 vertical elements, upper and lower horizontal elements. Filling: MDF panels of different thickness or glass 4 mm-thick. For each model you can select a decorative foil. Glass and other filling elements in these door leaves are not installed using glazing bars, but with all the construction elements at once, which greatly improves their stability.



## FOILS—TYPES OF WOOD TEXTURE (GRAINING):

Structures of INVADO foils can be divided into 3 categories:

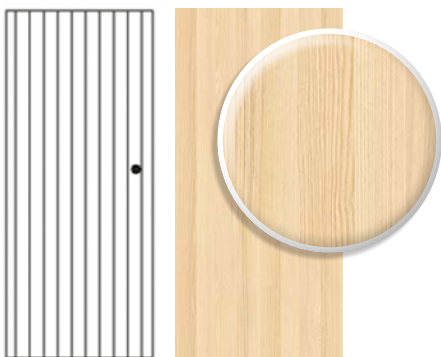

### UNIDIRECTIONAL FOIL WITH VERTICAL TEXTURE:

Most of INVADO foils is available in this type of texture. Exceptions: Chestnut (ENDURO), Italian oak and Severo oak (ENDURO 3D).



### UNIDIRECTIONAL FOIL WITH HORIZONTAL TEXTURE:

Currently in INVADO offer there are two foils with this texture. These are: Italian oak and Severo oak (ENDURO 3D).



### BIDIRECTIONAL FOIL WITH VERTICAL AND HORIZONTAL TEXTURE:

The combination of two previous types of texture. There is one foil of that type in the INVADO offer—Chestnut (ENDURO).

All 3 types of foils can be applied to foiled doors only. In case of modular doors, due to different construction, the texture direction of vertical and horizontal elements is different.

### REBATED AND NON-REBATED DOORS:

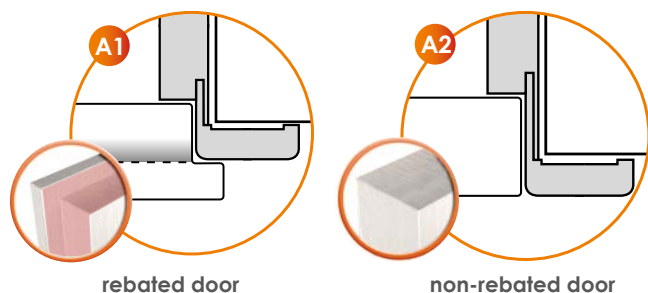

The edge of a **rebated door** leaf is finished with a rebate (visible on the picture A1) that overlaps a door frame when the door is closed. Door leaves made this way do not fit flush with a door frame.

The edge of a **non-rebated door** leaf has no additional finishing, i.e. it has a flat surface. Door leaves made this way fit flush with a door frame (A2).

### LEFT AND RIGHT DOOR:

#### left door



#### right door



Before buying a door, it is worth considering which direction it should be opening in. For safety reasons, bathroom or kitchen door should be installed in a way that makes it possible to open it outwards. In other areas, it is dependent on the users' preference and the layout of the apartment or the house. The next step is to determine which door we are looking for: right or left. What does it mean? If the hinges are installed on the right side of a door frame, that means we need a right door, if the opposite—we have to select the left door. Therefore, before going to the store it is worth to reconsider this question and write down a list of needed right and left doors, and to determine the opening direction for each of them.

### CALCULATION OF THE PRICE OF THE DOOR:

In most cases, the quoted prices are of a door leaf without a door frame or door handles. In order to obtain the full price of the door set, you have to use the following calculation:

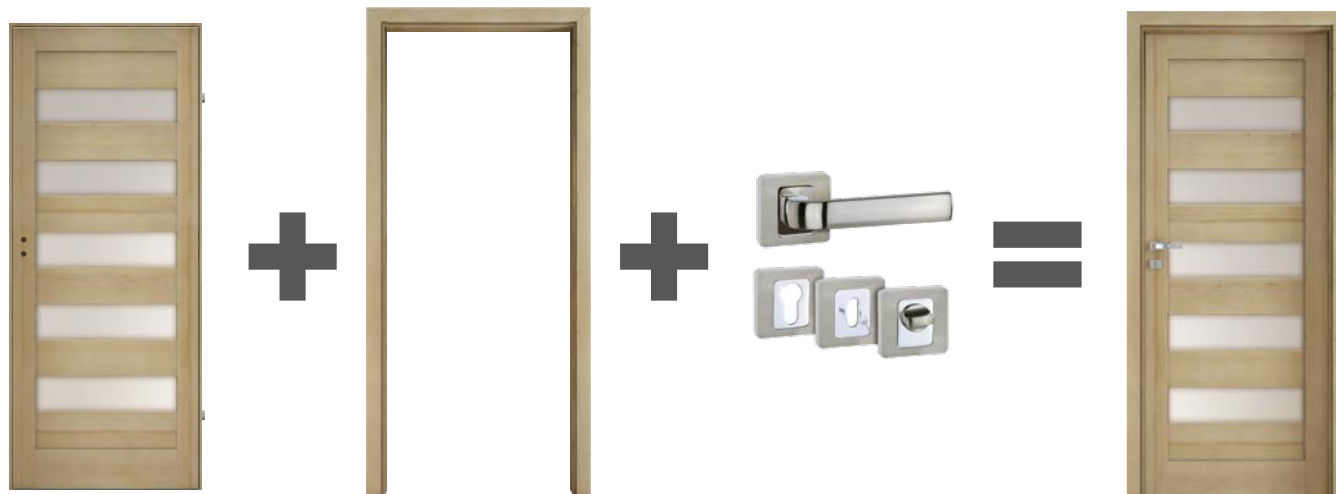

door leaf price

+

door frame price

+

handle price

=

door set price

### LEGEND

Please note the annotations marked with the following icons. They contain important informations related to a door leaf model.

ICONS REFERRING TO POSSIBLE OPTIONS OF DOOR LEAVES EXECUTION:						
	REBATED   NON-REBATED doors		SINGLE   DOUBLE doors		doors with VENTILATION	SLIDING SYSTEM

# AVAILABLE DECORS

## ENDURO foil

intensity of use: ●●○○○

**ENDURO classification:** Foil of high-quality design and very good imitation of a natural wood structure. High durability.  
**Intended for:** buildings and living quarters with a wide range of use.



## ENDURO 3D foil

intensity of use: ●●○○○

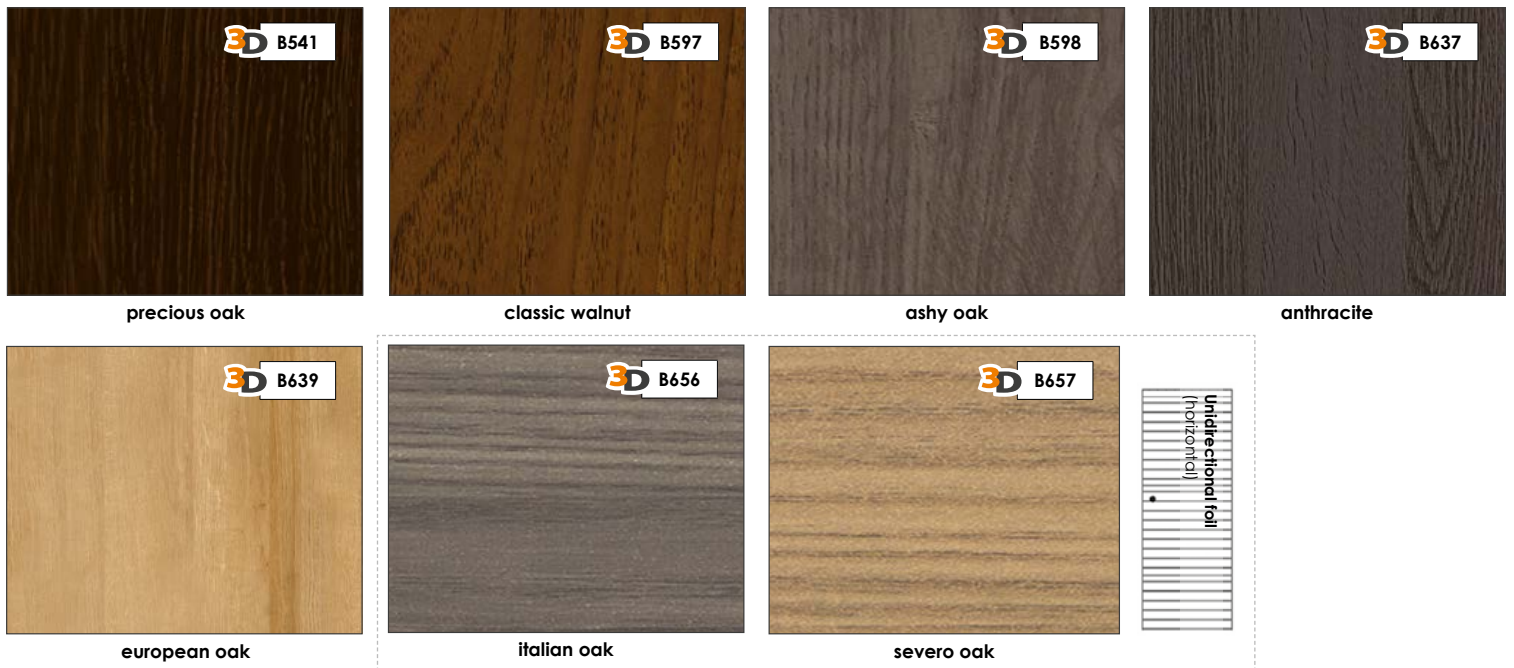

## ECO-FORNIR FORTE

intensity of use: ●●●○○

## ECO-VENEER CPL

**ECO-VENEER FORTE classification**—high quality laminate in modern colors, very high durability.  
**CPL**—foil in modern colors. **Intended for:** hotels, offices, public buildings.





**ENDURO PLUS** foil

intensity of use: ●●○○○



cedar forte

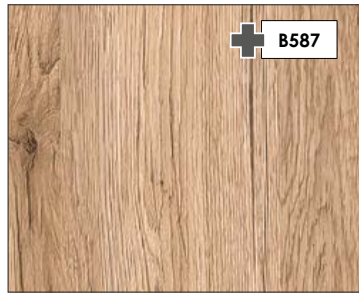

naturo oak

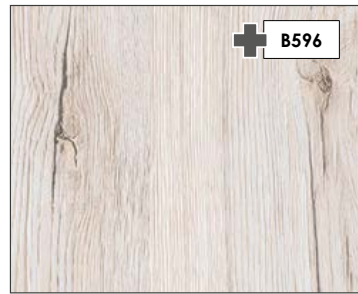

snowy oak



spring oak



winter oak



siberian larch

**ENDURO POLI** foil

intensity of use: ●●●●○



black

**Classification:** high quality polypropylene foil is characterised by excellent durability.  
**Intended for:** buildings and living quarters with a wide range of use

Only available as a door frame colour for:

- BLOCK DOOR FRAMES,
- ADJUSTABLE DOOR FRAMES,
- ADJUSTABLE DOOR FRAMES FOR NON-REBATED MODULAR DOORS

Can be combined with all models and colors of interior doors INVADO



**AVAILABLE GLASS**



transparent



satinato



chinchila





# collection of **MODULAR DOORS**

Corato .....	12
Artano.....	14
Aversa.....	14
Mirror .....	16
Lago.....	18
Pasaro.....	20
Vinadio .....	22
Fossano.....	24
Imperia .....	26
Destino Unico.....	28
Livata .....	30
Versano .....	32
Nogaro .....	34
Tamparo .....	36
Linea Forte .....	38
Capena Inserto .....	40
Martina .....	42
Domino.....	44
Bianco .....	46
Larina .....	48
D'Artagnan.....	50

# Corato

AVAILABLE OPTIONS OF DOOR LEAVES EXECUTION:



REBATED  
DOORS



NON-REBATED  
DOORS



SINGLE  
DOORS



DOUBLE  
DOORS



DOORS FOR  
SLIDING  
SYSTEMS



DOORS WITH  
VENTILATION



WATCH THE ASSEMBLY  
VIDEOS ON OUR  
YOUTUBE CHANNEL





## AVAILABLE DECORS

### ENDURO foil

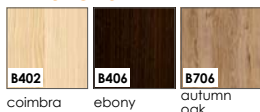

### ENDURO 3D foil

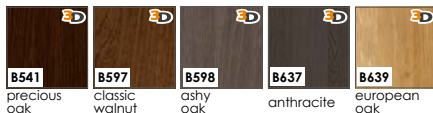

### ENDURO PLUS foil



### ECO-VENEER FORTE



### ECO-VENEER CPL

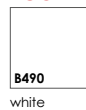

### ENDURO POLI foil

Only available as a door frame colour for:

- BLOCK DOOR FRAMES,
- ADJUSTABLE DOOR FRAMES,
- ADJUSTABLE DOOR FRAMES FOR NON-REBATED MODULAR DOORS

## CONSTRUCTION

- filling element: 22 mm-thick panel
- filling element: panel or glass, depending on the model (4 mm-thick)
- the frame is made of MDF board
  - upper part of the frame is 350 mm high, lower part of the frame is 400 mm high
- door leaf covered with ENDURO foil or ECO-VENEER
  - side edges and upper edge are foiled
  - rounded vertical edges of door leaves (**more info on page 86**)
  - in case of double doors, there is a covering strip (**drawing on page 86**)
  - width of single doors: "60"- "100" / width of double doors: "120"- "200"



## STANDARD EQUIPMENT FOR REBATED DOOR LEAVES

- lock 72 mm for a standard key, a WC knob, or a cylinder lock insert
- screw-in pivot hinges 13,5/9 (white zinc)—2 pcs for door leaves in sizes "60"- "80", 3 pcs for door leaves in sizes "90" and "100"

## STANDARD EQUIPMENT FOR NON-REBATED DOOR LEAVES

- magnetic lock 90 mm for a standard key or a WC knob, 85 mm for a cylinder lock insert
- hidden hinges with a 3-D regulation in the color CHROME/MATT

## ADDITIONAL OPTIONS CHARGED EXTRA

- door without a key hole no extra charge
- door width "100"
- additional hinge for the door in sizes "60"- "80"
- additional hinge for non-rebated door—included in a door frame door frame additional options—page 89
- caps for hinges (chrome, satin chrome, golden, black)
- ventilation undercut
- PVC ventilation sleeves
- metal ventilation sleeves, round (chrome, golden)
- metal ventilation sleeves, square (chrome, nickel)
- door made in a non-rebated version for sliding systems
- door made in a non-rebated version
- double door
  - cylinder lock insert 31/36 (31/31 in non-rebated door leaves)
  - automatic bottom door seal, widths "60"- "100"
  - aluminum thresholds, widths: "60"- "100"

## AVAILABLE GLASS (THE GLOSSY SIDE OF GLASS IS ON THE HINGE SIDE)



- satinato—tempered glass standard—no extra charge

## AVAILABLE DOOR FRAMES



- [OB3] block door frame (possibility to add an architrave 10 x 60 mm or 16 x 80 mm) page 87
- [ORS1] adjustable door frame with a flat angle architrave 60 mm-wide page 88
- [ORS8] adjustable door frame with a flat angle architrave 80 mm-wide page 88
- [ORS7] adjustable door frame for modular non-rebated doors with a flat angle architrave 60 mm-wide page 89
- [ORS10] adjustable door frame for modular non-rebated doors with a flat angle architrave 80 mm-wide page 89
- NOTE: THE OFFER ALSO INCLUDES METAL DOOR FRAMES page 90-91

# Artano and Aversa

AVAILABLE OPTIONS OF DOOR LEAVES EXECUTION:



REBATED DOORS



NON-REBATED DOORS



SINGLE DOORS



DOUBLE DOORS



DOORS FOR SLIDING SYSTEMS



DOORS WITH VENTILATION



WATCH THE ASSEMBLY VIDEOS ON OUR YOUTUBE CHANNEL





## AVAILABLE DECORS

### ENDURO foil

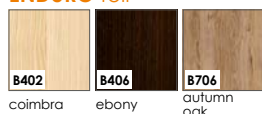

### ENDURO 3D foil

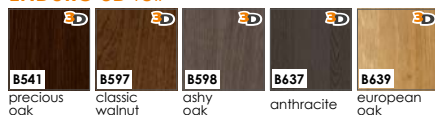

### ENDURO PLUS foil



### ECO-VENEER FORTE



### ECO-VENEER CPL

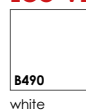

**ENDURO POLI foil**  
Only available as a door frame colour for:

- **BLOCK DOOR FRAMES,**
- **ADJUSTABLE DOOR FRAMES,**
- **ADJUSTABLE DOOR FRAMES FOR NON-REBATED MODULAR DOORS**

[B726] black

## CONSTRUCTION

- 1 • filling element: 16 mm-thick panel (Artano) / 22 mm-thick panel (Aversa)
- 2 • filling element: panel or glass, depending on the model (4 mm-thick)
- 3 • the frame is made of MDF board
- 4 • door leaf covered with ENDURO foil or ECO-VENEER

- side edges and upper edge are foiled
- rounded vertical edges of door leaves (**more info on page 86**)
- in case of double doors, there is a covering strip (**drawing on page 86**)
- width of single doors: "60"--"100" / width of double doors: "120"--"200"



## STANDARD EQUIPMENT FOR REBATED DOOR LEAVES

- **lock** 72 mm for a standard key, a WC knob, or a cylinder lock insert
- **screw-in pivot hinges** 13,5/9 (white zinc)—2 pcs for door leaves in sizes "60"--"80", 3 pcs for door leaves in sizes "90" and "100"

## STANDARD EQUIPMENT FOR NON-REBATED DOOR LEAVES

- **magnetic lock** 90 mm for a standard key or a WC knob, 85 mm for a cylinder lock insert
- **hidden hinges** with a 3-D regulation in the color CHROME/MATT

## ADDITIONAL OPTIONS CHARGED EXTRA

- door without a key hole no extra charge
- door width "100"
- additional hinge for the door in sizes "60"--"80"
- additional hinge for non-rebated door—included in a door frame door frame additional options—page 89
- caps for hinges (chrome, satin chrome, golden, black)
- ventilation undercut
- PVC ventilation sleeves
- metal ventilation sleeves, round (chrome, golden)
- metal ventilation sleeves, square (chrome, nickel)
- door made in a non-rebated version for sliding systems
- door made in a non-rebated version
- double door
- cylinder lock insert 31/36 (31/31 in non-rebated door leaves)
- automatic bottom door seal, widths "60"--"100"
- aluminum thresholds, widths: "60"--"100"

## AVAILABLE GLASS (THE GLOSSY SIDE OF GLASS IS ON THE HINGE SIDE)

- **satinato**—tempered glass standard—no extra charge

## AVAILABLE DOOR FRAMES

- **[OB3]** block door frame (possibility to add an architrave 10 x 60 mm or 16 x 80 mm) page 87
- **[ORS1]** adjustable door frame with a flat angle architrave 60 mm-wide page 88
- **[ORS8]** adjustable door frame with a flat angle architrave 80 mm-wide page 88
- **[ORS7]** adjustable door frame for modular non-rebated doors with a flat angle architrave 60 mm-wide page 89
- **[ORS10]** adjustable door frame for modular non-rebated doors with a flat angle architrave 80 mm-wide page 89
- **NOTE: THE OFFER ALSO INCLUDES METAL DOOR FRAMES** page 90-91

# Mirror

AVAILABLE OPTIONS OF DOOR LEAVES EXECUTION:



REBATED  
DOORS



NON-REBATED  
DOORS



SINGLE  
DOORS



DOUBLE  
DOORS



DOORS FOR  
SLIDING  
SYSTEMS



DOORS WITH  
VENTILATION



WATCH THE ASSEMBLY  
VIDEOS ON OUR  
YOUTUBE CHANNEL







**AVAILABLE DECORS**

**ENDURO foil**



**ENDURO 3D foil**

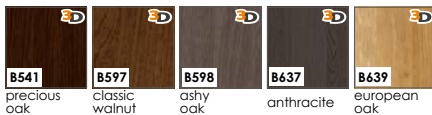

**ENDURO PLUS foil**

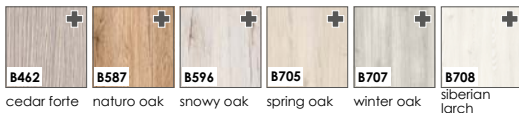

**ECO-VENEER FORTE**



**ECO-VENEER CPL**

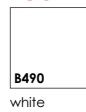

**ENDURO POLI foil**  
Only available as a door frame colour for:

- **BLOCK DOOR FRAMES,**
- **ADJUSTABLE DOOR FRAMES,**
- **ADJUSTABLE DOOR FRAMES FOR NON-REBATED MODULAR DOORS**

**CONSTRUCTION**

- 1 • filling element: panel (6 mm-thick)
- 2 • filling element: mirror (4 mm-thick)
- 3 • the frame is made of MDF board
- 4 • door leaf covered with ENDURO foil or ECO-VENEER

- side edges and upper edge are foiled
- rounded vertical edges of door leaves (**more info on page 86**)
- in case of double doors, there is a covering strip (**drawing on page 86**)
- width of single doors: "60"--"100" / width of double doors: "120"--"200"



**STANDARD EQUIPMENT FOR REBATED DOOR LEAVES**

- **lock** 72 mm for a standard key, a WC knob, or a cylinder lock insert
- **screw-in pivot hinges** 13,5/9 (white zinc)—2 pcs for door leaves in sizes "60"--"80", 3 pcs for door leaves in sizes "90" and "100"

**STANDARD EQUIPMENT FOR NON-REBATED DOOR LEAVES**

- **magnetic lock** 90 mm for a standard key or a WC knob, 85 mm for a cylinder lock insert
- **hidden hinges** with a 3-D regulation in the color CHROME/MATT

**ADDITIONAL OPTIONS CHARGED EXTRA**

- door without a key hole no extra charge
- door width "100"
- additional hinge for the door in sizes "60"--"80"
- additional hinge for non-rebated door—included in a door frame door frame additional options—page 89
- caps for hinges (chrome, satin chrome, golden, black)
- ventilation undercut
- PVC ventilation sleeves
- metal ventilation sleeves, round (chrome, golden)
- metal ventilation sleeves, square (chrome, nickel)
- door made in a non-rebated version for sliding systems
- door made in a non-rebated version
- double door
- cylinder lock insert 31/36 (31/31 in non-rebated door leaves)
- automatic bottom door seal, widths "60"--"100"
- aluminum thresholds, widths: "60"--"100"

**AVAILABLE DOOR FRAMES**



- **[OB3]** block door frame (possibility to add an architrave 10 x 60 mm or 16 x 80 mm) page 87
- **[ORS1]** adjustable door frame with a flat angle architrave 60 mm-wide page 88
- **[ORS8]** adjustable door frame with a flat angle architrave 80 mm-wide page 88
- **[ORS7]** adjustable door frame for modular non-rebated doors with a flat angle architrave 60 mm-wide page 89
- **[ORS10]** adjustable door frame for modular non-rebated doors with a flat angle architrave 80 mm-wide page 89
- **NOTE: THE OFFER ALSO INCLUDES METAL DOOR FRAMES** page 90-91

# Lago

AVAILABLE OPTIONS OF DOOR LEAVES EXECUTION:



REBATED  
DOORS



NON-REBATED  
DOORS



SINGLE  
DOORS



DOUBLE  
DOORS



DOORS FOR  
SLIDING  
SYSTEMS



DOORS WITH  
VENTILATION



WATCH THE ASSEMBLY  
VIDEOS ON OUR  
YOUTUBE CHANNEL





**AVAILABLE DECORS**

**ENDURO foil**

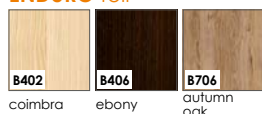

**ENDURO 3D foil**

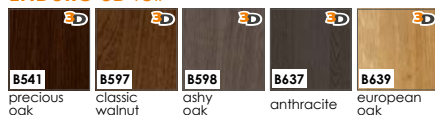

**ENDURO PLUS foil**



**ECO-VENEER FORTE**



**ECO-VENEER CPL**

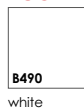

**ENDURO POLI foil**  
Only available as a door frame colour for:

- **BLOCK DOOR FRAMES,**
- **ADJUSTABLE DOOR FRAMES,**
- **ADJUSTABLE DOOR FRAMES FOR NON-REBATED MODULAR DOORS**

**CONSTRUCTION**

- 1 • filling element: 22 mm-thick panel
  - 2 • filling element: panel or glass, depending on the model (4 mm-thick)
  - 3 • the frame is made of MDF board
  - 4 • door leaf covered with ENDURO foil or ECO-VENEER
- side edges and upper edge are foiled
  - rounded vertical edges of door leaves (**more info on page 86**)
  - in case of double doors, there is a covering strip (**drawing on page 86**)
  - width of single doors: "60"--"100" / width of double doors: "120"--"200"



**STANDARD EQUIPMENT FOR REBATED DOOR LEAVES**

- **lock** 72 mm for a standard key, a WC knob, or a cylinder lock insert
- **screw-in pivot hinges** 13.5/9 (white zinc)—2 pcs for door leaves in sizes "60"--"80", 3 pcs for door leaves in sizes "90" and "100"

**STANDARD EQUIPMENT FOR NON-REBATED DOOR LEAVES**

- **magnetic lock** 90 mm for a standard key or a WC knob, 85 mm for a cylinder lock insert
- **hidden hinges** with a 3-D regulation in the color CHROME/MATT

**ADDITIONAL OPTIONS CHARGED EXTRA**

- door without a key hole **no extra charge**
- door width "100"
- additional hinge for the door in sizes "60"--"80"
- additional hinge for non-rebated door—included in a door frame **door frame additional options—page 89**
- caps for hinges (chrome, satin chrome, golden, black)
- ventilation undercut
- PVC ventilation sleeves
- metal ventilation sleeves, round (chrome, golden)
- metal ventilation sleeves, square (chrome, nickel)
- door made in a non-rebated version for sliding systems
- door made in a non-rebated version
- double door
- cylinder lock insert 31/36 (31/31 in non-rebated door leaves)
- automatic bottom door seal, widths "60"--"100"
- aluminum thresholds, widths: "60"--"100"

**AVAILABLE GLASS** (THE GLOSSY SIDE OF GLASS IS ON THE HINGE SIDE)

- **satinato**—tempered glass **standard—no extra charge**

**AVAILABLE DOOR FRAMES**

- **[OB3]** block door frame (possibility to add an architrave 10 x 60 mm or 16 x 80 mm) **page 87**
- **[ORS1]** adjustable door frame with a flat angle architrave 60 mm-wide **page 88**
- **[ORS8]** adjustable door frame with a flat angle architrave 80 mm-wide **page 88**
- **[ORS7]** adjustable door frame for modular non-rebated doors with a flat angle architrave 60 mm-wide **page 89**
- **[ORS10]** adjustable door frame for modular non-rebated doors with a flat angle architrave 80 mm-wide **page 89**
- **NOTE: THE OFFER ALSO INCLUDES METAL DOOR FRAMES** **page 90-91**



# Pasaro

AVAILABLE OPTIONS OF DOOR LEAVES EXECUTION:



REBATED DOORS



NON-REBATED DOORS



SINGLE DOORS



DOUBLE DOORS



DOORS FOR SLIDING SYSTEMS



DOORS WITH VENTILATION



WATCH THE ASSEMBLY VIDEOS ON OUR YOUTUBE CHANNEL





## AVAILABLE DECORS

### ENDURO foil

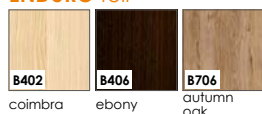

### ENDURO 3D foil

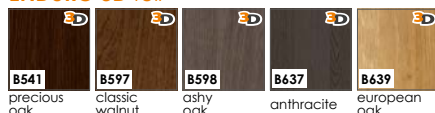

### ENDURO PLUS foil



### ECO-VENEER FORTE



### ECO-VENEER CPL

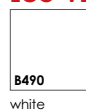

**ENDURO POLI foil**  
Only available as a door frame colour for:

- BLOCK DOOR FRAMES,
- ADJUSTABLE DOOR FRAMES,
- ADJUSTABLE DOOR FRAMES FOR NON-REBATED MODULAR DOORS

[B726] black

## CONSTRUCTION

- 1 • filling element: 22 mm-thick panel
- 2 • filling element: panel or glass, depending on the model (4 mm-thick)
- 3 • the frame is made of MDF board
  - upper part of the frame is 350 mm high, lower part of the frame is 400 mm high
- 4 • door leaf covered with ENDURO foil or ECO-VENEER
  - side edges and upper edge are foiled
  - rounded vertical edges of door leaves (**more info on page 86**)
  - in case of double doors, there is a covering strip (**drawing on page 86**)
  - width of single doors: "60"--"100" / width of double doors: "120"--"200"



## STANDARD EQUIPMENT FOR REBATED DOOR LEAVES

- lock 72 mm for a standard key, a WC knob, or a cylinder lock insert
- screw-in pivot hinges 13,5/9 (white zinc)—2 pcs for door leaves in sizes "60"--"80", 3 pcs for door leaves in sizes "90" and "100"

## STANDARD EQUIPMENT FOR NON-REBATED DOOR LEAVES

- magnetic lock 90 mm for a standard key or a WC knob, 85 mm for a cylinder lock insert
- hidden hinges with a 3-D regulation in the color CHROME/MATT

## ADDITIONAL OPTIONS CHARGED EXTRA

- door without a key hole no extra charge
- door width "100"
- additional hinge for the door in sizes "60"--"80"
- additional hinge for non-rebated door—included in a door frame door frame additional options—page 89
- caps for hinges (chrome, satin chrome, golden, black)
- ventilation undercut
- PVC ventilation sleeves
- metal ventilation sleeves, round (chrome, golden)
- metal ventilation sleeves, square (chrome, nickel)
- door made in a non-rebated version for sliding systems
- door made in a non-rebated version
- double door
  - cylinder lock insert 31/36 (31/31 in non-rebated door leaves)
  - automatic bottom door seal, widths "60"--"100"
  - aluminum thresholds, widths: "60"--"100"

## AVAILABLE GLASS (THE GLOSSY SIDE OF GLASS IS ON THE HINGE SIDE)

- satinato—tempered glass standard—no extra charge

## AVAILABLE DOOR FRAMES

- [OB3] block door frame (possibility to add an architrave 10 x 60 mm or 16 x 80 mm) page 87
- [ORS1] adjustable door frame with a flat angle architrave 60 mm-wide page 88
- [ORS8] adjustable door frame with a flat angle architrave 80 mm-wide page 88
- [ORS7] adjustable door frame for modular non-rebated doors with a flat angle architrave 60 mm-wide page 89
- [ORS10] adjustable door frame for modular non-rebated doors with a flat angle architrave 80 mm-wide page 89
- NOTE: THE OFFER ALSO INCLUDES METAL DOOR FRAMES page 90-91





REBATED  
DOORS



NON-REBATED  
DOORS



SINGLE  
DOORS



DOUBLE  
DOORS



DOORS FOR  
SLIDING  
SYSTEMS



DOORS WITH  
VENTILATION



WATCH THE ASSEMBLY  
VIDEOS ON OUR  
YOUTUBE CHANNEL





Vinadio 1



Vinadio 2



Vinadio 3

**AVAILABLE DECORS**

**ENDURO foil**

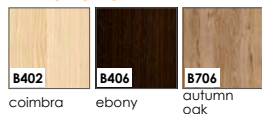

**ENDURO 3D foil**

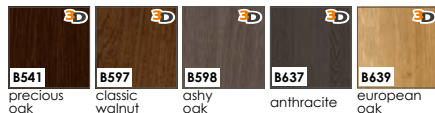

**ENDURO PLUS foil**



**ECO-VENEER FORTE**



**ECO-VENEER CPL**

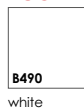

**ENDURO POLI foil**  
Only available as a door frame colour for:

- **BLOCK DOOR FRAMES,**
- **ADJUSTABLE DOOR FRAMES,**
- **ADJUSTABLE DOOR FRAMES FOR NON-REBATED MODULAR DOORS**

**CONSTRUCTION**

- 1 • filling element: 22 mm-thick panel
  - 2 • filling element: panel or glass, depending on the model (4 mm-thick)
  - 3 • the frame is made of MDF board
  - 4 • door leaf covered with ENDURO foil or ECO-VENEER
- side edges and upper edge are foiled
  - rounded vertical edges of door leaves (**more info on page 86**)
  - in case of double doors, there is a covering strip (**drawing on page 86**)
  - width of single doors: "60"--"100" / width of double doors: "120"--"200"



**STANDARD EQUIPMENT FOR REBATED DOOR LEAVES**

- **lock** 72 mm for a standard key, a WC knob, or a cylinder lock insert
- **screw-in pivot hinges** 13,5/9 (white zinc)—2 pcs for door leaves in sizes "60"--"80", 3 pcs for door leaves in sizes "90" and "100"

**STANDARD EQUIPMENT FOR NON-REBATED DOOR LEAVES**

- **magnetic lock** 90 mm for a standard key or a WC knob, 85 mm for a cylinder lock insert
- **hidden hinges** with a 3-D regulation in the color CHROME/MATT

**ADDITIONAL OPTIONS CHARGED EXTRA**

- door without a key hole no extra charge
- door width "100"
- additional hinge for the door in sizes "60"--"80"
- additional hinge for non-rebated door—included in a door frame door frame additional options—page 89
- caps for hinges (chrome, satin chrome, golden, black)
- ventilation undercut
- PVC ventilation sleeves
- metal ventilation sleeves, round (chrome, golden)
- metal ventilation sleeves, square (chrome, nickel)
- door made in a non-rebated version for sliding systems
- door made in a non-rebated version
- double door
- cylinder lock insert 31/36 (31/31 in non-rebated door leaves)
- automatic bottom door seal, widths "60"--"100"
- aluminum thresholds, widths: "60"--"100"

**AVAILABLE GLASS** (THE GLOSSY SIDE OF GLASS IS ON THE HINGE SIDE)



- **satinato**—tempered glass standard—no extra charge

**AVAILABLE DOOR FRAMES**



- **[OB3]** block door frame (possibility to add an architrave 10 x 60 mm or 16 x 80 mm) page 87
- **[ORS1]** adjustable door frame with a flat angle architrave 60 mm-wide page 88
- **[ORS8]** adjustable door frame with a flat angle architrave 80 mm-wide page 88
- **[ORS7]** adjustable door frame for modular non-rebated doors with a flat angle architrave 60 mm-wide page 89
- **[ORS10]** adjustable door frame for modular non-rebated doors with a flat angle architrave 80 mm-wide page 89
- **NOTE: THE OFFER ALSO INCLUDES METAL DOOR FRAMES** page 90-91

# Fossano

AVAILABLE OPTIONS OF DOOR LEAVES EXECUTION:



REBATED  
DOORS



NON-REBATED  
DOORS



SINGLE  
DOORS



DOUBLE  
DOORS



DOORS FOR  
SLIDING  
SYSTEMS



DOORS WITH  
VENTILATION



WATCH THE ASSEMBLY  
VIDEOS ON OUR  
YOUTUBE CHANNEL







**AVAILABLE DECORS**

**ENDURO foil**

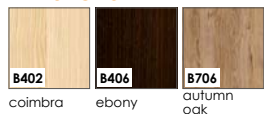

**ENDURO 3D foil**

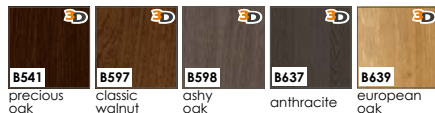

**ENDURO PLUS foil**



**ECO-VENEER FORTE**



**ECO-VENEER CPL**

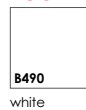

**ENDURO POLI foil**  
Only available as a door frame colour for:

- BLOCK DOOR FRAMES,
- ADJUSTABLE DOOR FRAMES,
- ADJUSTABLE DOOR FRAMES FOR NON-REBATED MODULAR DOORS

**CONSTRUCTION**

- 1 • filling element: 22 mm-thick panel
- 2 • filling element: panel or glass, depending on the model (4 mm-thick)
- 3 • the frame is made of MDF board
- 4 • door leaf covered with ENDURO foil or ECO-VENEER



- side edges and upper edge are foiled
- rounded vertical edges of door leaves (**more info on page 86**)
- in case of double doors, there is a covering strip (**drawing on page 86**)
- width of single doors: "60"--"100" / width of double doors: "120"--"200"

**STANDARD EQUIPMENT FOR REBATED DOOR LEAVES**

- lock 72 mm for a standard key, a WC knob, or a cylinder lock insert
- screw-in pivot hinges 13,5/9 (white zinc)—2 pcs for door leaves in sizes "60"--"80", 3 pcs for door leaves in sizes "90" and "100"

**STANDARD EQUIPMENT FOR NON-REBATED DOOR LEAVES**

- magnetic lock 90 mm for a standard key or a WC knob, 85 mm for a cylinder lock insert
- hidden hinges with a 3-D regulation in the color CHROME/MATT

**ADDITIONAL OPTIONS CHARGED EXTRA**

- door without a key hole no extra charge
- door width "100"
- additional hinge for the door in sizes "60"--"80"
- additional hinge for non-rebated door—included in a door frame door frame additional options—page 89
- caps for hinges (chrome, satin chrome, golden, black)
- ventilation undercut
- PVC ventilation sleeves
- metal ventilation sleeves, round (chrome, golden)
- metal ventilation sleeves, square (chrome, nickel)
- door made in a non-rebated version for sliding systems
- door made in a non-rebated version
- double door
- cylinder lock insert 31/36 (31/31 in non-rebated door leaves)
- automatic bottom door seal, widths "60"--"100"
- aluminum thresholds, widths: "60"--"100"

**AVAILABLE GLASS** (THE GLOSSY SIDE OF GLASS IS ON THE HINGE SIDE)



- satinato—tempered glass standard—no extra charge

**AVAILABLE DOOR FRAMES**



- [OB3] block door frame (possibility to add an architrave 10 x 60 mm or 16 x 80 mm) page 87
- [ORS1] adjustable door frame with a flat angle architrave 60 mm-wide page 88
- [ORS8] adjustable door frame with a flat angle architrave 80 mm-wide page 88
- [ORS7] adjustable door frame for modular non-rebated doors with a flat angle architrave 60 mm-wide page 89
- [ORS10] adjustable door frame for modular non-rebated doors with a flat angle architrave 80 mm-wide page 89
- NOTE: THE OFFER ALSO INCLUDES METAL DOOR FRAMES page 90-91

# Imperia

AVAILABLE OPTIONS OF DOOR LEAVES EXECUTION:



REBATED DOORS



NON-REBATED DOORS



SINGLE DOORS



DOUBLE DOORS



DOORS FOR SLIDING SYSTEMS



DOORS WITH VENTILATION



WATCH THE ASSEMBLY VIDEOS ON OUR YOUTUBE CHANNEL





**AVAILABLE DECORS**

**ENDURO foil**



**ENDURO 3D foil**

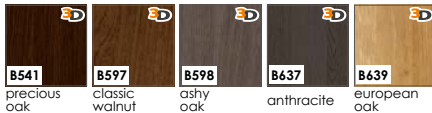

**ENDURO PLUS foil**



**ECO-VENEER FORTE**



**ECO-VENEER CPL**

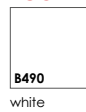

**ENDURO POLI foil**  
Only available as a door frame colour for:

- BLOCK DOOR FRAMES,
- ADJUSTABLE DOOR FRAMES,
- ADJUSTABLE DOOR FRAMES FOR NON-REBATED MODULAR DOORS

**CONSTRUCTION**

- filling element: 22 mm-thick panel
- filling element: panel or glass, depending on the model (4 mm-thick)
- the frame is made of MDF board
  - upper part of the frame is 350 mm high, lower part of the frame element is 400 mm high
- door leaf covered with ENDURO foil or ECO-VENEER
  - side edges and upper edge are foiled
  - rounded vertical edges of door leaves (**more info on page 86**)
  - in case of double doors, there is a covering strip (**drawing on page 86**)
  - width of single doors: "60"- "100" / width of double doors: "120"- "200"



**STANDARD EQUIPMENT FOR REBATED DOOR LEAVES**

- lock 72 mm for a standard key, a WC knob, or a cylinder lock insert
- screw-in pivot hinges 13,5/9 (white zinc)—2 pcs for door leaves in sizes "60"- "80", 3 pcs for door leaves in sizes "90" and "100"

**STANDARD EQUIPMENT FOR NON-REBATED DOOR LEAVES**

- magnetic lock 90 mm for a standard key or a WC knob, 85 mm for a cylinder lock insert
- hidden hinges with a 3-D regulation in the color CHROME/MATT

**ADDITIONAL OPTIONS CHARGED EXTRA**

- door without a key hole no extra charge
- door width "100"
- additional hinge for the door in sizes "60"- "80"
- additional hinge for non-rebated door—included in a door frame door frame additional options—page 89
- caps for hinges (chrome, satin chrome, golden, black)
- ventilation undercut
- PVC ventilation sleeves
- metal ventilation sleeves, round (chrome, golden)
- metal ventilation sleeves, square (chrome, nickel)
- door made in a non-rebated version for sliding systems
- door made in a non-rebated version
- double door
  - cylinder lock insert 31/36 (31/31 in non-rebated door leaves)
  - automatic bottom door seal, widths "60"- "100"
  - aluminum thresholds, widths: "60"- "100"

**AVAILABLE GLASS** (THE GLOSSY SIDE OF GLASS IS ON THE HINGE SIDE)



- satinato—tempered glass standard—no extra charge

**AVAILABLE DOOR FRAMES**



- [OB3] block door frame (possibility to add an architrave 10 x 60 mm or 16 x 80 mm) page 87
- [ORS1] adjustable door frame with a flat angle architrave 60 mm-wide page 88
- [ORS8] adjustable door frame with a flat angle architrave 80 mm-wide page 88
- [ORS7] adjustable door frame for modular non-rebated doors with a flat angle architrave 60 mm-wide page 89
- [ORS10] adjustable door frame for modular non-rebated doors with a flat angle architrave 80 mm-wide page 89
- NOTE: THE OFFER ALSO INCLUDES METAL DOOR FRAMES page 90-91

# Destino Unico

AVAILABLE OPTIONS OF DOOR LEAVES EXECUTION:



REBATED DOORS



NON-REBATED DOORS



SINGLE DOORS



DOUBLE DOORS



DOORS FOR SLIDING SYSTEMS



DOORS WITH VENTILATION



WATCH THE ASSEMBLY VIDEOS ON OUR YOUTUBE CHANNEL





One of the most popular models of INVADO doors—DESTINO UNICO—has been awarded a “Gold Medal”. These door leaves are a bold combination of colors, that allows to create intriguing, stylized interiors.

Therefore we had no doubt, that this is the collection to be submitted to the prestigious “Gold Medal” contest, held at the International Poznań Fair BUDMA. The IPF “Gold Medal” is one of the most recognizable awards in the Polish market, which is given to innovative products of the highest quality. We are proud and we thank to all those involved in the production and sale of doors Destino Unico.

## AVAILABLE DECORS

### ENDURO foil

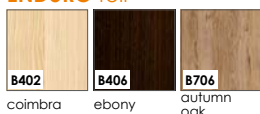

### ENDURO 3D foil

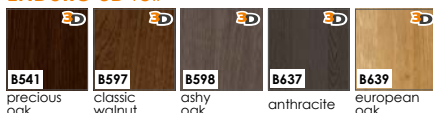

### ENDURO PLUS foil



### ECO-VENEER FORTE



### ECO-VENEER CPL

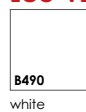

### ENDURO POLI foil

Only available as a door frame colour for:

- BLOCK DOOR FRAMES,
- ADJUSTABLE DOOR FRAMES,
- ADJUSTABLE DOOR FRAMES FOR NON-REBATED MODULAR DOORS

## CONSTRUCTION

- 1 • filling element: panel or glass, depending on the model (4 mm-thick)
- 2 • filling element: 22 mm-thick panel
- 3 • the frame is made of MDF board
- 4 • double-sided glass insert—80 mm wide
- 5 • door leaf covered with ENDURO foil or ECO-VENEER
  - side edges and upper edge are foiled
  - rounded vertical edges of door leaves (**more info on page 86**)
  - in case of double doors, there is a covering strip (**drawing on page 86**)
  - width of single doors: “60”-“100” / width of double doors: “120”-“200”



## STANDARD EQUIPMENT FOR REBATED DOOR LEAVES

- lock 72 mm for a standard key, a WC knob, or a cylinder lock insert
- screw-in pivot hinges 13,5/9 (white zinc)—2 pcs for door leaves in sizes “60”-“80”, 3 pcs for door leaves in sizes “90” and “100”

## STANDARD EQUIPMENT FOR NON-REBATED DOOR LEAVES

- magnetic lock 90 mm for a standard key or a WC knob, 85 mm for a cylinder lock insert
- hidden hinges with a 3-D regulation in the color CHROME/MATT

## ADDITIONAL OPTIONS CHARGED EXTRA

- door without a key hole **no extra charge**
- door width “100”
- additional hinge for the door in sizes “60”-“80”
- additional hinge for non-rebated door—included in a door frame **door frame additional options—page 89**
- caps for hinges (chrome, satin chrome, golden, black)
- ventilation undercut
- PVC ventilation sleeves
- metal ventilation sleeves, round (chrome, golden)
- metal ventilation sleeves, square (chrome, nickel)
- door made in a non-rebated version for sliding systems
- door made in a non-rebated version
- double door
  - cylinder lock insert 31/36 (31/31 in non-rebated door leaves)
  - automatic bottom door seal, widths “60”-“100”
  - aluminum thresholds, widths: “60”-“100”

## AVAILABLE GLASS (THE GLOSSY SIDE OF GLASS IS ON THE HINGE SIDE)



### AVAILABLE COLORS OF GLASS INSERT: :



- satinato—tempered glass **standard—no extra charge**

## AVAILABLE DOOR FRAMES



- [OB3] block door frame (possibility to add an architrave 10 x 60 mm or 16 x 80 mm) **page 87**
- [ORS1] adjustable door frame with a flat angle architrave 60 mm-wide **page 88**
- [ORS8] adjustable door frame with a flat angle architrave 80 mm-wide **page 88**
- [ORS7] adjustable door frame for modular non-rebated doors with a flat angle architrave 60 mm-wide **page 89**
- [ORS10] adjustable door frame for modular non-rebated doors with a flat angle architrave 80 mm-wide **page 89**
- NOTE: THE OFFER ALSO INCLUDES METAL DOOR FRAMES **page 90-91**



REBATED  
DOORS



NON-REBATED  
DOORS



SINGLE  
DOORS



DOUBLE  
DOORS



DOORS FOR  
SLIDING  
SYSTEMS



DOORS WITH  
VENTILATION



WATCH THE ASSEMBLY  
VIDEOS ON OUR  
YOUTUBE CHANNEL





### AVAILABLE DECORS

#### ENDURO foil



#### ENDURO 3D foil

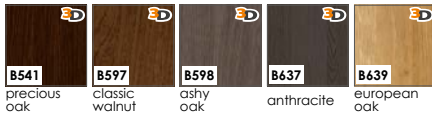

#### ENDURO PLUS foil



#### ECO-VENEER FORTE



#### ECO-VENEER CPL

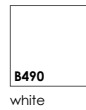

**ENDURO POLI foil**  
Only available as a door frame colour for:

- BLOCK DOOR FRAMES,
- ADJUSTABLE DOOR FRAMES,
- ADJUSTABLE DOOR FRAMES FOR NON-REBATED MODULAR DOORS

### CONSTRUCTION

- 1 • filling element: panel or glass, depending on the model (4 mm-thick)
  - 2 • filling element: 22 mm-thick panel
  - 3 • the frame is made of MDF board
  - 4 • door leaf covered with ENDURO foil or ECO-VENEER
- side edges and upper edge are foiled
  - rounded vertical edges of door leaves (**more info on page 86**)
  - in case of double doors, there is a covering strip (**drawing on page 86**)
  - width of single doors: "60"- "100" / width of double doors: "120"- "200"



### STANDARD EQUIPMENT FOR REBATED DOOR LEAVES

- lock 72 mm for a standard key, a WC knob, or a cylinder lock insert
- screw-in pivot hinges 13,5/9 (white zinc)—2 pcs for door leaves in sizes "60"- "80", 3 pcs for door leaves in sizes "90" and "100"

### STANDARD EQUIPMENT FOR NON-REBATED DOOR LEAVES

- magnetic lock 90 mm for a standard key or a WC knob, 85 mm for a cylinder lock insert
- hidden hinges with a 3-D regulation in the color CHROME/MATT

### ADDITIONAL OPTIONS CHARGED EXTRA

- door without a key hole no extra charge
- door width "100"
- additional hinge for the door in sizes "60"- "80"
- additional hinge for non-rebated door—included in a door frame door frame additional options—page 89
- caps for hinges (chrome, satin chrome, golden, black)
- ventilation undercut
- PVC ventilation sleeves
- metal ventilation sleeves, round (chrome, golden)
- metal ventilation sleeves, square (chrome, nickel)
- door made in a non-rebated version for sliding systems
- door made in a non-rebated version
- double door
- cylinder lock insert 31/36 (31/31 in non-rebated door leaves)
- automatic bottom door seal, widths "60"- "100"
- aluminum thresholds, widths: "60"- "100"

### AVAILABLE GLASS (THE GLOSSY SIDE OF GLASS IS ON THE HINGE SIDE)



- satinato—tempered glass standard—no extra charge

### AVAILABLE DOOR FRAMES



- [OB3] block door frame (possibility to add an architrave 10 x 60 mm or 16 x 80 mm) page 87
- [ORS1] adjustable door frame with a flat angle architrave 60 mm-wide page 88
- [ORS8] adjustable door frame with a flat angle architrave 80 mm-wide page 88
- [ORS7] adjustable door frame for modular non-rebated doors with a flat angle architrave 60 mm-wide page 89
- [ORS10] adjustable door frame for modular non-rebated doors with a flat angle architrave 80 mm-wide page 89
- NOTE: THE OFFER ALSO INCLUDES METAL DOOR FRAMES page 90-91

# Versano

AVAILABLE OPTIONS OF DOOR LEAVES EXECUTION:



REBATED DOORS



NON-REBATED DOORS



SINGLE DOORS



DOUBLE DOORS



DOORS FOR SLIDING SYSTEMS



DOORS WITH VENTILATION



WATCH THE ASSEMBLY VIDEOS ON OUR YOUTUBE CHANNEL







**AVAILABLE DECORS**

**ENDURO foil**

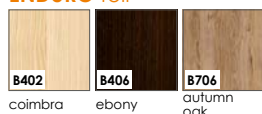

**ENDURO 3D foil**

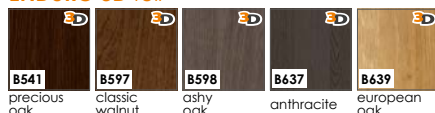

**ENDURO PLUS foil**



**ECO-VENEER FORTE**



**ECO-VENEER CPL**

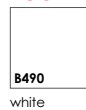

**ENDURO POLI foil**  
Only available as a door frame colour for:

- **BLOCK DOOR FRAMES,**
- **ADJUSTABLE DOOR FRAMES,**
- **ADJUSTABLE DOOR FRAMES FOR NON-REBATED MODULAR DOORS**

**CONSTRUCTION**

- filling element: 22 mm-thick panel
- filling element: panel or glass, depending on the model (4 mm-thick)
- the frame is made of MDF board, upper part of the frame is 350 mm high, lower part of the frame is 400 mm high
- door leaf covered with ENDURO foil or ECO-VENEER
  - side edges and upper edge are foiled
  - rounded vertical edges of door leaves (**more info on page 86**)
  - in case of double doors, there is a covering strip (**drawing on page 86**)
  - width of single doors: "60"--"100" / width of double doors: "120"--"200"



**STANDARD EQUIPMENT FOR REBATED DOOR LEAVES**

- **lock** 72 mm for a standard key, a WC knob, or a cylinder lock insert
- **screw-in pivot hinges** 13,5/9 (white zinc)—2 pcs for door leaves in sizes "60"--"80", 3 pcs for door leaves in sizes "90" and "100"

**STANDARD EQUIPMENT FOR NON-REBATED DOOR LEAVES**

- **magnetic lock** 90 mm for a standard key or a WC knob, 85 mm for a cylinder lock insert
- **hidden hinges** with a 3-D regulation in the color CHROME/MATT

**ADDITIONAL OPTIONS CHARGED EXTRA**

- door without a key hole no extra charge
- door width "100"
- additional hinge for the door in sizes "60"--"80"
- additional hinge for non-rebated door—included in a door frame door frame additional options—page 89
- caps for hinges (chrome, satin chrome, golden, black)
- ventilation undercut
- PVC ventilation sleeves
- metal ventilation sleeves, round (chrome, golden)
- metal ventilation sleeves, square (chrome, nickel)
- door made in a non-rebated version for sliding systems
- door made in a non-rebated version
- double door
  - cylinder lock insert 31/36 (31/31 in non-rebated door leaves)
  - automatic bottom door seal, widths "60"--"100"
  - aluminum thresholds, widths: "60"--"100"

**AVAILABLE GLASS** (THE GLOSSY SIDE OF GLASS IS ON THE HINGE SIDE)

- **satinato**—tempered glass standard—no extra charge

**AVAILABLE DOOR FRAMES**

- **[OB3]** block door frame (possibility to add an architrave 10 x 60 mm or 16 x 80 mm) page 87
- **[ORS1]** adjustable door frame with a flat angle architrave 60 mm-wide page 88
- **[ORS8]** adjustable door frame with a flat angle architrave 80 mm-wide page 88
- **[ORS7]** adjustable door frame for modular non-rebated doors with a flat angle architrave 60 mm-wide page 89
- **[ORS10]** adjustable door frame for modular non-rebated doors with a flat angle architrave 80 mm-wide page 89
- **NOTE: THE OFFER ALSO INCLUDES METAL DOOR FRAMES** page 90-91



# Nogaro

AVAILABLE OPTIONS OF DOOR LEAVES EXECUTION:



REBATED DOORS



NON-REBATED DOORS



SINGLE DOORS



DOUBLE DOORS



DOORS FOR SLIDING SYSTEMS



DOORS WITH VENTILATION



WATCH THE ASSEMBLY VIDEOS ON OUR YOUTUBE CHANNEL





## AVAILABLE DECORS

### ENDURO foil

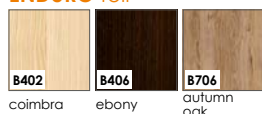

### ENDURO 3D foil

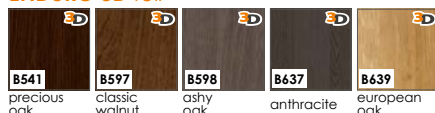

### ENDURO PLUS foil



### ECO-VENEER FORTE



### ECO-VENEER CPL

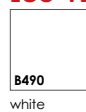

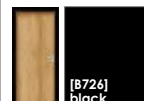

**ENDURO POLI foil**  
Only available as a door frame colour for:

- BLOCK DOOR FRAMES,
- ADJUSTABLE DOOR FRAMES,
- ADJUSTABLE DOOR FRAMES FOR NON-REBATED MODULAR DOORS

## CONSTRUCTION

- 1 • filling element: 22 mm-thick panel
  - 2 • filling element: panel or glass, depending on the model (4 mm-thick)
  - 3 • the frame is made of MDF board
  - 4 • door leaf covered with ENDURO foil or ECO-VENEER
- side edges and upper edge are foiled
  - rounded vertical edges of door leaves (**more info on page 86**)
  - in case of double doors, there is a covering strip (**drawing on page 86**)
  - width of single doors: "60"--"100" / width of double doors: "120"--"200"



## STANDARD EQUIPMENT FOR REBATED DOOR LEAVES

- lock 72 mm for a standard key, a WC knob, or a cylinder lock insert
- screw-in pivot hinges 13.5/9 (white zinc)—2 pcs for door leaves in sizes "60"--"80", 3 pcs for door leaves in sizes "90" and "100"

## STANDARD EQUIPMENT FOR NON-REBATED DOOR LEAVES

- magnetic lock 90 mm for a standard key or a WC knob, 85 mm for a cylinder lock insert
- hidden hinges with a 3-D regulation in the color CHROME/MATT

## ADDITIONAL OPTIONS CHARGED EXTRA

- door without a key hole no extra charge
- door width "100"
- additional hinge for the door in sizes "60"--"80"
- additional hinge for non-rebated door—included in a door frame door frame additional options—page 89
- caps for hinges (chrome, satin chrome, golden, black)
- ventilation undercut
- PVC ventilation sleeves
- metal ventilation sleeves, round (chrome, golden)
- metal ventilation sleeves, square (chrome, nickel)
- door made in a non-rebated version for sliding systems
- door made in a non-rebated version
- double door
- cylinder lock insert 31/36 (31/31 in non-rebated door leaves)
- automatic bottom door seal, widths "60"--"100"
- aluminum thresholds, widths: "60"--"100"

## AVAILABLE GLASS (THE GLOSSY SIDE OF GLASS IS ON THE HINGE SIDE)

- satinato—tempered glass standard—no extra charge

## AVAILABLE DOOR FRAMES

- [OB3] block door frame (possibility to add an architrave 10 x 60 mm or 16 x 80 mm) page 87
- [ORS1] adjustable door frame with a flat angle architrave 60 mm-wide page 88
- [ORS8] adjustable door frame with a flat angle architrave 80 mm-wide page 88
- [ORS7] adjustable door frame for modular non-rebated doors with a flat angle architrave 60 mm-wide page 89
- [ORS10] adjustable door frame for modular non-rebated doors with a flat angle architrave 80 mm-wide page 89
- NOTE: THE OFFER ALSO INCLUDES METAL DOOR FRAMES page 90-91

# Tamparo

AVAILABLE OPTIONS OF DOOR LEAVES EXECUTION:



REBATED  
DOORS



NON-REBATED  
DOORS



SINGLE  
DOORS



DOUBLE  
DOORS



DOORS FOR  
SLIDING  
SYSTEMS



DOORS WITH  
VENTILATION



WATCH THE ASSEMBLY  
VIDEOS ON OUR  
YOUTUBE CHANNEL





## AVAILABLE DECORS

### ENDURO foil

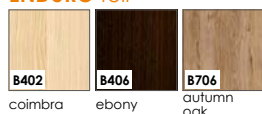

### ENDURO 3D foil

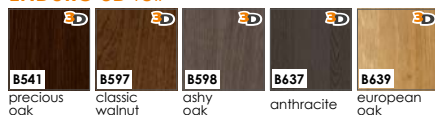

### ENDURO PLUS foil



### ECO-VENEER FORTE



### ECO-VENEER CPL

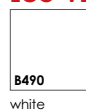

### ENDURO POLI foil

Only available as a door frame colour for:

- BLOCK DOOR FRAMES,
- ADJUSTABLE DOOR FRAMES,
- ADJUSTABLE DOOR FRAMES FOR NON-REBATED MODULAR DOORS

## CONSTRUCTION

- 1 • filling element: panel or glass, depending on the model (4 mm-thick)
- 2 • filling element: 22 mm-thick panel
- 3 • the frame is made of MDF board
- 4 • door leaf covered with ENDURO foil or ECO-VENEER

- side edges and upper edge are foiled
- rounded vertical edges of door leaves (**more info on page 86**)
- in case of double doors, there is a covering strip (**drawing on page 86**)
- width of single doors: "60"—"100" / width of double doors: "120"—"200"



## STANDARD EQUIPMENT FOR REBATED DOOR LEAVES

- lock 72 mm for a standard key, a WC knob, or a cylinder lock insert
- screw-in pivot hinges 13,5/9 (white zinc)—2 pcs for door leaves in sizes "60"—"80", 3 pcs for door leaves in sizes "90" and "100"

## STANDARD EQUIPMENT FOR NON-REBATED DOOR LEAVES

- magnetic lock 90 mm for a standard key or a WC knob, 85 mm for a cylinder lock insert
- hidden hinges with a 3-D regulation in the color CHROME/MATT

## ADDITIONAL OPTIONS CHARGED EXTRA

- door without a key hole no extra charge
- door width "100"
- additional hinge for the door in sizes "60"—"80"
- additional hinge for non-rebated door—included in a door frame door frame additional options—page 89
- caps for hinges (chrome, satin chrome, golden, black)
- ventilation undercut
- PVC ventilation sleeves
- metal ventilation sleeves, round (chrome, golden)
- metal ventilation sleeves, square (chrome, nickel)
- door made in a non-rebated version for sliding systems
- door made in a non-rebated version
- double door
- cylinder lock insert 31/36 (31/31 in non-rebated door leaves)
- automatic bottom door seal, widths "60"—"100"
- aluminum thresholds, widths: "60"—"100"

## AVAILABLE GLASS (THE GLOSSY SIDE OF GLASS IS ON THE HINGE SIDE)



- satinato—tempered glass standard—no extra charge

## AVAILABLE DOOR FRAMES



- [OB3] block door frame (possibility to add an architrave 10 x 60 mm or 16 x 80 mm) page 87
- [ORS1] adjustable door frame with a flat angle architrave 60 mm-wide page 88
- [ORS8] adjustable door frame with a flat angle architrave 80 mm-wide page 88
- [ORS7] adjustable door frame for modular non-rebated doors with a flat angle architrave 60 mm-wide page 89
- [ORS10] adjustable door frame for modular non-rebated doors with a flat angle architrave 80 mm-wide page 89
- NOTE: THE OFFER ALSO INCLUDES METAL DOOR FRAMES page 90–91

# Linea Forte

AVAILABLE OPTIONS OF DOOR LEAVES EXECUTION:



REBATED DOORS



NON-REBATED DOORS



SINGLE DOORS



DOUBLE DOORS



DOORS FOR SLIDING SYSTEMS



DOORS WITH VENTILATION



WATCH THE ASSEMBLY VIDEOS ON OUR YOUTUBE CHANNEL





## AVAILABLE DECORS

### ENDURO foil

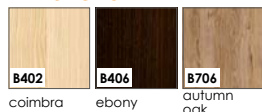

### ENDURO 3D foil

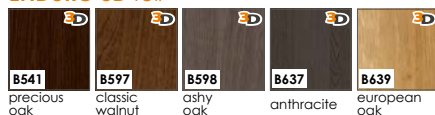

### ENDURO PLUS foil



### ECO-VENEER FORTE



### ECO-VENEER CPL

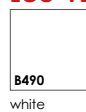

### ENDURO POLI foil

Only available as a door frame colour for:

- BLOCK DOOR FRAMES,
- ADJUSTABLE DOOR FRAMES,
- ADJUSTABLE DOOR FRAMES FOR NON-REBATED MODULAR DOORS



## CONSTRUCTION

- 1 • filling element: 22 mm-thick panel
- 2 • filling element: panel or glass, depending on the model (4 mm-thick)
- 3 • the frame is made of MDF board
- 4 • door leaf covered with ENDURO foil or ECO-VENEER

- side edges and upper edge are foiled
- rounded vertical edges of door leaves (**more info on page 86**)
- in case of double doors, there is a covering strip (**drawing on page 86**)
- width of single doors: "60"—"100" / width of double doors: "120"—"200"



## STANDARD EQUIPMENT FOR REBATED DOOR LEAVES

- lock 72 mm for a standard key, a WC knob, or a cylinder lock insert
- screw-in pivot hinges 13.5/9 (white zinc)—2 pcs for door leaves in sizes "60"—"80", 3 pcs for door leaves in sizes "90" and "100"

## STANDARD EQUIPMENT FOR NON-REBATED DOOR LEAVES

- magnetic lock 90 mm for a standard key or a WC knob, 85 mm for a cylinder lock insert
- hidden hinges with a 3-D regulation in the color CHROME/MATT

## ADDITIONAL OPTIONS CHARGED EXTRA

- door without a key hole **no extra charge**
- door width "100"
- additional hinge for the door in sizes "60"—"80"
- additional hinge for non-rebated door—included in a door frame **door frame additional options—page 89**
- caps for hinges (chrome, satin chrome, golden, black)
- ventilation undercut
- PVC ventilation sleeves
- metal ventilation sleeves, round (chrome, golden)
- metal ventilation sleeves, square (chrome, nickel)
- door made in a non-rebated version for sliding systems
- door made in a non-rebated version
- double door
- cylinder lock insert 31/36 (31/31 in non-rebated door leaves)
- automatic bottom door seal, widths "60"—"100"
- aluminum thresholds, widths: "60"—"100"

## AVAILABLE GLASS (THE GLOSSY SIDE OF GLASS IS ON THE HINGE SIDE)

- satinato—tempered glass **standard—no extra charge**



## AVAILABLE DOOR FRAMES

- [OB3] block door frame (possibility to add an architrave 10 x 60 mm or 16 x 80 mm) **page 87**
- [ORS1] adjustable door frame with a flat angle architrave 60 mm-wide **page 88**
- [ORS8] adjustable door frame with a flat angle architrave 80 mm-wide **page 88**
- [ORS7] adjustable door frame for modular non-rebated doors with a flat angle architrave 60 mm-wide **page 89**
- [ORS10] adjustable door frame for modular non-rebated doors with a flat angle architrave 80 mm-wide **page 89**
- NOTE: THE OFFER ALSO INCLUDES METAL DOOR FRAMES **page 90–91**



# Capena Inserto

AVAILABLE OPTIONS OF DOOR LEAVES EXECUTION:



REBATED DOORS



NON-REBATED DOORS



SINGLE DOORS



DOUBLE DOORS



DOORS FOR SLIDING SYSTEMS



DOORS WITH VENTILATION



WATCH THE ASSEMBLY VIDEOS ON OUR YOUTUBE CHANNEL







**AVAILABLE DECORS**

**ENDURO foil**

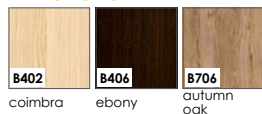

**ENDURO 3D foil**

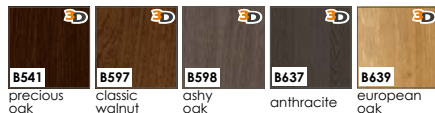

**ENDURO PLUS foil**



**ECO-VENEER FORTE**



**ECO-VENEER CPL**

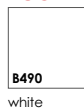

**ENDURO POLI foil**  
Only available as a door frame colour for:

- BLOCK DOOR FRAMES,
- ADJUSTABLE DOOR FRAMES,
- ADJUSTABLE DOOR FRAMES FOR NON-REBATED MODULAR DOORS

**CONSTRUCTION**

- filling element: panel or glass, depending on the model (4 mm-thick)
- filling element: 22 mm-thick panel
- the frame is made of MDF board
- ALU strip—8 mm
- door leaf covered with ENDURO foil or ECO-VENEER
  - side edges and upper edge are foiled
  - rounded vertical edges of door leaves (**more info on page 86**)
  - in case of double doors, there is a covering strip (**drawing on page 86**)
  - width of single doors: "60"—"100" / width of double doors: "120"—"200"



**STANDARD EQUIPMENT FOR REBATED DOOR LEAVES**

- lock 72 mm for a standard key, a WC knob, or a cylinder lock insert
- screw-in pivot hinges 13.5/9 (white zinc)—2 pcs for door leaves in sizes "60"—"80", 3 pcs for door leaves in sizes "90" and "100"

**STANDARD EQUIPMENT FOR NON-REBATED DOOR LEAVES**

- magnetic lock 90 mm for a standard key or a WC knob, 85 mm for a cylinder lock insert
- hidden hinges with a 3-D regulation in the color CHROME/MATT

**ADDITIONAL OPTIONS CHARGED EXTRA**

- door without a key hole **no extra charge**
- door width "100"
- additional hinge for the door in sizes "60"—"80"
- additional door—included in a door frame **door frame additional options—page 89**
- caps for hinges (chrome, satin chrome, golden, black)
- ventilation undercut
- PVC ventilation sleeves
- metal ventilation sleeves, round (chrome, golden)
- metal ventilation sleeves, square (chrome, nickel)
- door made in a non-rebated version for sliding systems
- door made in a non-rebated version
- double door
  - cylinder lock insert 31/36 (31/31 in non-rebated door leaves)
  - automatic bottom door seal, widths "60"—"100"
  - aluminum thresholds, widths: "60"—"100"

**AVAILABLE GLASS** (THE GLOSSY SIDE OF GLASS IS ON THE HINGE SIDE)



- satinato—tempered glass **standard—no extra charge**

**AVAILABLE DOOR FRAMES**



- [OB3] block door frame (possibility to add an architrave 10 x 60 mm or 16 x 80 mm) **page 87**
- [ORS1] adjustable door frame with a flat angle architrave 60 mm-wide **page 88**
- [ORS8] adjustable door frame with a flat angle architrave 80 mm-wide **page 88**
- [ORS7] adjustable door frame for modular non-rebated doors with a flat angle architrave 60 mm-wide **page 89**
- [ORS10] adjustable door frame for modular non-rebated doors with a flat angle architrave 80 mm-wide **page 89**
- NOTE: THE OFFER ALSO INCLUDES METAL DOOR FRAMES **page 90–91**

# Martina

AVAILABLE OPTIONS OF DOOR LEAVES EXECUTION:



REBATED  
DOORS



NON-REBATED  
DOORS



SINGLE  
DOORS



DOUBLE  
DOORS



DOORS FOR  
SLIDING  
SYSTEMS



DOORS WITH  
VENTILATION



WATCH THE ASSEMBLY  
VIDEOS ON OUR  
YOUTUBE CHANNEL





## AVAILABLE DECORS

### ENDURO foil

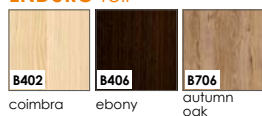

### ENDURO 3D foil

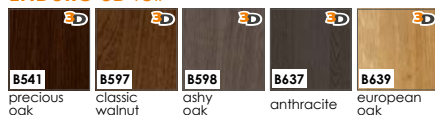

### ENDURO PLUS foil



### ECO-VENEER FORTE



### ECO-VENEER CPL

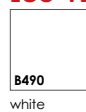

### ENDURO POLI foil

Only available as a door frame colour for:

- BLOCK DOOR FRAMES,
- ADJUSTABLE DOOR FRAMES,
- ADJUSTABLE DOOR FRAMES FOR NON-REBATED MODULAR DOORS

## CONSTRUCTION

- 1 • filling element: panel or glass, depending on the model (4 mm-thick)
- 2 • filling element: 22 mm-thick panel
- 3 • the frame is made of MDF board
- 4 • door leaf covered with ENDURO foil or ECO-VENEER

- side edges and upper edge are foiled
- rounded vertical edges of door leaves (**more info on page 86**)
- in case of double doors, there is a covering strip (**drawing on page 86**)
- width of single doors: "60"- "100" / width of double doors: "120"- "200"



## STANDARD EQUIPMENT FOR REBATED DOOR LEAVES

- lock 72 mm for a standard key, a WC knob, or a cylinder lock insert
- screw-in pivot hinges 13.5/9 (white zinc)—2 pcs for door leaves in sizes "60"- "80", 3 pcs for door leaves in sizes "90" and "100"

## STANDARD EQUIPMENT FOR NON-REBATED DOOR LEAVES

- magnetic lock 90 mm for a standard key or a WC knob, 85 mm for a cylinder lock insert
- hidden hinges with a 3-D regulation in the color CHROME/MATT

## ADDITIONAL OPTIONS CHARGED EXTRA

- door without a key hole no extra charge
- door width "100"
- additional hinge for the door in sizes "60"- "80"
- additional hinge for non-rebated door—included in a door frame door frame additional options—page 89
- caps for hinges (chrome, satin chrome, golden, black)
- ventilation undercut
- PVC ventilation sleeves
- metal ventilation sleeves, round (chrome, golden)
- metal ventilation sleeves, square (chrome, nickel)
- door made in a non-rebated version for sliding systems
- door made in a non-rebated version
- double door
- cylinder lock insert 31/36 (31/31 in non-rebated door leaves)
- automatic bottom door seal, widths "60"- "100"
- aluminum thresholds, widths: "60"- "100"

## AVAILABLE GLASS (THE GLOSSY SIDE OF GLASS IS ON THE HINGE SIDE)



- satinato—tempered glass standard—no extra charge

## AVAILABLE DOOR FRAMES



- [OB3] block door frame (possibility to add an architrave 10 x 60 mm or 16 x 80 mm) page 87
- [ORS1] adjustable door frame with a flat angle architrave 60 mm-wide page 88
- [ORS8] adjustable door frame with a flat angle architrave 80 mm-wide page 88
- [ORS7] adjustable door frame for modular non-rebated doors with a flat angle architrave 60 mm-wide page 89
- [ORS10] adjustable door frame for modular non-rebated doors with a flat angle architrave 80 mm-wide page 89
- NOTE: THE OFFER ALSO INCLUDES METAL DOOR FRAMES page 90-91

# Domino

AVAILABLE OPTIONS OF DOOR LEAVES EXECUTION:



REBATED  
DOORS



NON-REBATED  
DOORS



SINGLE  
DOORS



DOUBLE  
DOORS



DOORS FOR  
SLIDING  
SYSTEMS



DOORS WITH  
VENTILATION



WATCH THE ASSEMBLY  
VIDEOS ON OUR  
YOUTUBE CHANNEL





**AVAILABLE DECORS**

**ENDURO foil**

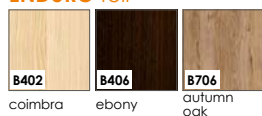

**ENDURO 3D foil**

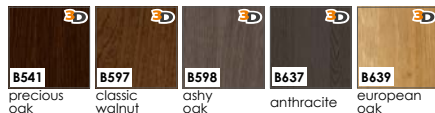

**ENDURO PLUS foil**



**ECO-VENEER FORTE**



**ECO-VENEER CPL**

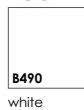

**ENDURO POLI foil**  
Only available as a door frame colour for:

- **BLOCK DOOR FRAMES,**
- **ADJUSTABLE DOOR FRAMES,**
- **ADJUSTABLE DOOR FRAMES FOR NON-REBATED MODULAR DOORS**

**CONSTRUCTION**

- 1 • filling element: 10 mm-thick panel
  - 2 • filling element: panel or glass, depending on the model (4 mm-thick)
  - 3 • the frame is made of MDF board
  - 4 • door leaf covered with ENDURO foil or ECO-VENEER
- side edges and upper edge are foiled
  - rounded vertical edges of door leaves (**more info on page 86**)
  - in case of double doors, there is a covering strip (**drawing on page 86**)
  - width of single doors: "60"—"100" / width of double doors: "120"—"200"



**STANDARD EQUIPMENT FOR REBATED DOOR LEAVES**

- **lock 72 mm** for a standard key, a WC knob, or a cylinder lock insert
- **screw-in pivot hinges 13,5/9** (white zinc)—2 pcs for door leaves in sizes "60"—"80", 3 pcs for door leaves in sizes "90" and "100"

**STANDARD EQUIPMENT FOR NON-REBATED DOOR LEAVES**

- **magnetic lock 90 mm** for a standard key or a WC knob, 85 mm for a cylinder lock insert
- **hidden hinges** with a 3-D regulation in the color CHROME/MATT

**ADDITIONAL OPTIONS CHARGED EXTRA**

- door without a key hole no extra charge
- door width "100"
- additional hinge for the door in sizes "60"—"80"
- additional hinge for non-rebated door—included in a door frame door frame additional options—page 89
- caps for hinges (chrome, satin chrome, golden, black)
- ventilation undercut
- PVC ventilation sleeves
- metal ventilation sleeves, round (chrome, golden)
- metal ventilation sleeves, square (chrome, nickel)
- door made in a non-rebated version for sliding systems
- door made in a non-rebated version
- double door
- cylinder lock insert 31/36 (31/31 in non-rebated door leaves)
- automatic bottom door seal, widths "60"—"100"
- aluminum thresholds, widths: "60"—"100"

**AVAILABLE GLASS** (THE GLOSSY SIDE OF GLASS IS ON THE HINGE SIDE)

- **satinato**—tempered glass standard—no extra charge

**AVAILABLE DOOR FRAMES**

- **[OB3]** block door frame (possibility to add an architrave 10 x 60 mm or 16 x 80 mm) page 87
- **[ORS1]** adjustable door frame with a flat angle architrave 60 mm-wide page 88
- **[ORS8]** adjustable door frame with a flat angle architrave 80 mm-wide page 88
- **[ORS7]** adjustable door frame for modular non-rebated doors with a flat angle architrave 60 mm-wide page 89
- **[ORS10]** adjustable door frame for modular non-rebated doors with a flat angle architrave 80 mm-wide page 89
- **NOTE: THE OFFER ALSO INCLUDES METAL DOOR FRAMES** page 90-91



# Bianco

AVAILABLE OPTIONS OF DOOR LEAVES EXECUTION:



REBATED  
DOORS



NON-REBATED  
DOORS



SINGLE  
DOORS



DOUBLE  
DOORS



DOORS FOR  
SLIDING  
SYSTEMS



DOORS WITH  
VENTILATION



WATCH THE ASSEMBLY  
VIDEOS ON OUR  
YOUTUBE CHANNEL





## AVAILABLE DECORS

### ECO-VENEER CPL



B490

## CONSTRUCTION

- 1 • filling element: MDF board (33 mm-thick)
- 2 • filling element: panel (10 mm-thick) or glass (4 mm-thick), depending on the model
- 3 • the frame is made of MDF board
- 4 • door leaf covered with ENDURO foil or ECO-VENEER

- side edges and upper edge are foiled
- rounded vertical edges of door leaves (**more info on page 86**)
- in case of double doors, there is a covering strip (**drawing on page 86**)
- width of single doors: "60"-100" / width of double doors: "120"-200"



## STANDARD EQUIPMENT FOR REBATED DOOR LEAVES

- lock 72 mm for a standard key, a WC knob, or a cylinder lock insert
- screw-in pivot hinges 13,5/9 (white zinc)—2 pcs for door leaves in sizes "60"-80", 3 pcs for door leaves in sizes "90" and "100"

## STANDARD EQUIPMENT FOR NON-REBATED DOOR LEAVES

- magnetic lock 90 mm for a standard key or a WC knob, 85 mm for a cylinder lock insert
- hidden hinges with a 3-D regulation in the color CHROME/MATT

## ADDITIONAL OPTIONS CHARGED EXTRA

- door without a key hole no extra charge
- door width "100"
- additional hinge for the door in sizes "60"-80"
- additional hinge for non-rebated door—included in a door frame door frame additional options—page 89
- caps for hinges (chrome, satin chrome, golden, black)
- ventilation undercut
- PVC ventilation sleeves
- metal ventilation sleeves, round (chrome, golden)
- metal ventilation sleeves, square (chrome, nickel)
- door made in a non-rebated version for sliding systems
- door made in a non-rebated version
- double door
- cylinder lock insert 31/36 (31/31 in non-rebated door leaves)
- automatic bottom door seal, widths "60"-100"
- aluminum thresholds, widths: "60"-100"

### ENDURO POLI foil

Only available as a door frame colour for:

- BLOCK DOOR FRAMES,
- ADJUSTABLE DOOR FRAMES,
- ADJUSTABLE DOOR FRAMES FOR NON-REBATED MODULAR DOORS



[B726]  
black

## AVAILABLE GLASS (THE GLOSSY SIDE OF GLASS IS ON THE HINGE SIDE)



satinato

- satinato—tempered glass standard—no extra charge

## AVAILABLE DOOR FRAMES



- [OB3] block door frame (possibility to add an architrave 10 x 60 mm or 16 x 80 mm) page 87
- [ORS1] adjustable door frame with a flat angle architrave 60 mm-wide page 88
- [ORS8] adjustable door frame with a flat angle architrave 80 mm-wide page 88
- [ORS7] adjustable door frame for modular non-rebated doors with a flat angle architrave 60 mm-wide page 89
- [ORS10] adjustable door frame for modular non-rebated doors with a flat angle architrave 80 mm-wide page 89
- NOTE: THE OFFER ALSO INCLUDES METAL DOOR FRAMES page 90-91

# Larina

AVAILABLE OPTIONS OF DOOR LEAVES EXECUTION:



REBATED  
DOORS



NON-REBATED  
DOORS



SINGLE  
DOORS



DOUBLE  
DOORS



DOORS FOR  
SLIDING  
SYSTEMS



DOORS WITH  
VENTILATION



WATCH THE ASSEMBLY  
VIDEOS ON OUR  
YOUTUBE CHANNEL





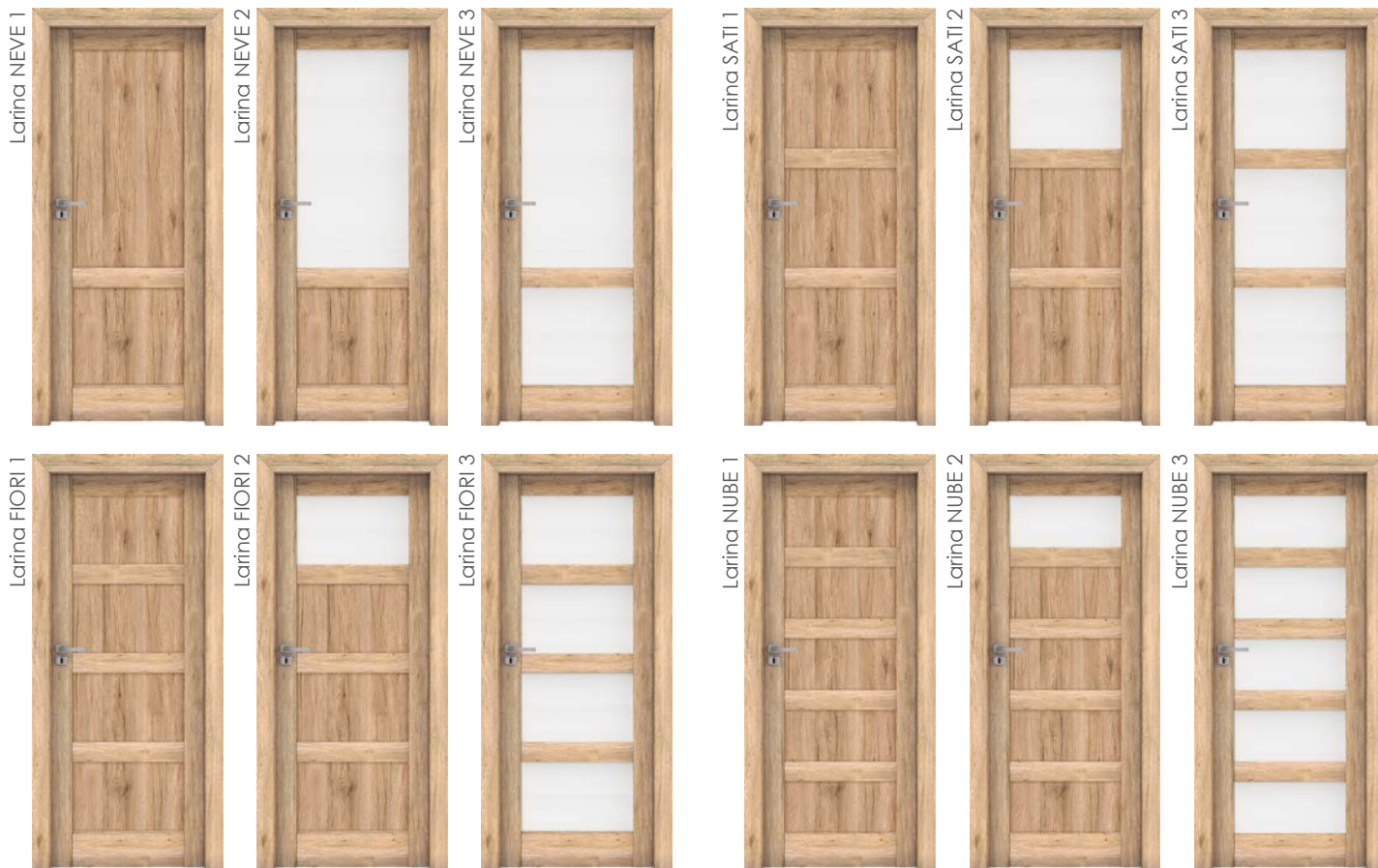

## AVAILABLE DECORS

### ENDURO foil

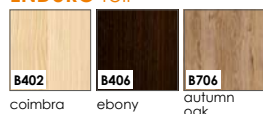

### ENDURO 3D foil

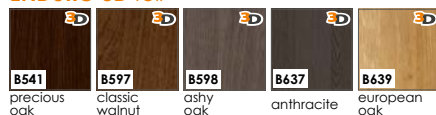

### ENDURO PLUS foil



### ECO-VENEER FORTE



### ENDURO POLI foil

Only available as a door frame colour for:

- BLOCK DOOR FRAMES,
- ADJUSTABLE DOOR FRAMES,
- ADJUSTABLE DOOR FRAMES FOR NON-REBATED MODULAR DOORS



## CONSTRUCTION

- 1 • filling element: MDF board (35 mm-thick)
- 2 • filling element: panel (10 mm-thick) or glass (4 mm-thick), depending on the model
- 3 • the frame is made of MDF board
- 4 • door leaf covered with ENDURO foil or ECO-VENEER

- side edges and upper edge are foiled
- rounded vertical edges of door leaves (**more info on page 86**)
- in case of double doors, there is a covering strip (**drawing on page 86**)
- width of single doors: "60"--"100" / width of double doors: "120"--"200"



## STANDARD EQUIPMENT FOR REBATED DOOR LEAVES

- lock 72 mm for a standard key, a WC knob, or a cylinder lock insert
- screw-in pivot hinges 13,5/9 (white zinc)—2 pcs for door leaves in sizes "60"--"80", 3 pcs for door leaves in sizes "90" and "100"

## STANDARD EQUIPMENT FOR NON-REBATED DOOR LEAVES

- magnetic lock 90 mm for a standard key or a WC knob, 85 mm for a cylinder lock insert
- hidden hinges with a 3-D regulation in the color CHROME/MATT

## ADDITIONAL OPTIONS CHARGED EXTRA

- door without a key hole no extra charge
- door width "100"
- additional hinge for the door in sizes "60"--"80"
- additional hinge for non-rebated door—included in a door frame door frame additional options—page 89
- caps for hinges (chrome, satin chrome, golden, black)
- ventilation undercut
- PVC ventilation sleeves
- metal ventilation sleeves, round (chrome, golden)
- metal ventilation sleeves, square (chrome, nickel)
- door made in a non-rebated version for sliding systems
- door made in a non-rebated version
- double door
- cylinder lock insert 31/36 (31/31 in non-rebated door leaves)
- automatic bottom door seal, widths "60"--"100"
- aluminum thresholds, widths: "60"--"100"

## AVAILABLE GLASS (THE GLOSSY SIDE OF GLASS IS ON THE HINGE SIDE)



- satinato—tempered glass standard—no extra charge

## AVAILABLE DOOR FRAMES



- [OB3] block door frame (possibility to add an architrave 10 x 60 mm or 16 x 80 mm) page 87
- [ORS1] adjustable door frame with a flat angle architrave 60 mm-wide page 88
- [ORS8] adjustable door frame with a flat angle architrave 80 mm-wide page 88
- [ORS7] adjustable door frame for modular non-rebated doors with a flat angle architrave 60 mm-wide page 89
- [ORS10] adjustable door frame for modular non-rebated doors with a flat angle architrave 80 mm-wide page 89
- NOTE: THE OFFER ALSO INCLUDES METAL DOOR FRAMES page 90-91

# D'Artagnan

AVAILABLE OPTIONS OF DOOR LEAVES EXECUTION:



REBATED  
DOORS



NON-REBATED  
DOORS



SINGLE  
DOORS



DOUBLE  
DOORS



DOORS WITH  
VENTILATION



WATCH THE ASSEMBLY  
VIDEOS ON OUR  
YOUTUBE CHANNEL





**AVAILABLE DECORS**

**ENDURO foil**

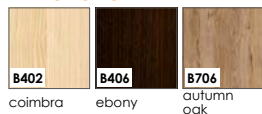

**ENDURO 3D foil**

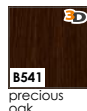

**ENDURO PLUS foil**

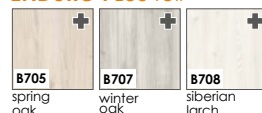

**ECO-VENEER FORTE**



**ECO-VENEER CPL**

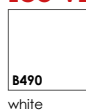

**ENDURO POLI foil**  
Only available as a door frame colour for:

- **BLOCK DOOR FRAMES,**
- **ADJUSTABLE DOOR FRAMES,**
- **ADJUSTABLE DOOR FRAMES FOR NON-REBATED MODULAR DOORS**

**CONSTRUCTION**

- 1 • frame is made of finger joint pinewood, covered with MDF and HDF boards
- 2 • filling element: panel (10 mm-thick) or glass (6 mm-thick), depending on the mode
- 3 • door leaf covered with ENDURO foil or ECO-VENEER

- side edges and upper edge are foiled
- rounded vertical edges of door leaves (**more info on page 86**)
- in case of double doors, there is a covering strip (**drawing on page 86**)
- width of single doors: "60"- "100" / width of double doors: "120"- "200"

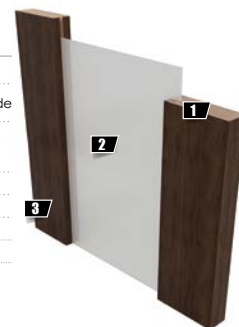

**STANDARD EQUIPMENT REBATED DOOR LEAVES**

- **lock** 72 mm for a standard key, a WC knob or cylinder lock insert
- **screw-in pivot hinges** 13,5/9 (white zinc)—2 pcs for door leaves in sizes "60"- "80", 3 pcs for door leaves in sizes "90" and "100"

**STANDARD EQUIPMENT NON-REBATED DOOR LEAVES**

- **magnetic lock** 90 mm for standard key or WC knob and 85 mm for cylinder lock insert
- **hidden hinges** with regulation 3D in CHROME/MAT color

**ADDITIONAL OPTIONS AT EXTRA CHARGE**

- door without a key hole no extra charge
- door width "100"
- additional hinge in door width from "60"- "80"
- additional hinge in non-rebated door door frame additional options—page 89
- caps for hinges
- ventilation undercut (model INTERO)
- door made in non-rebated version
- double door
- cylinder lock insert 31/36 (31/31 in non-rebated door leaves)
- aluminum thresholds, widths: "60"- "100"

**AVAILABLE GLASS** (THE MATT (ENGRAVED) SIDE OF GLASS IS LOCATED ON THE HINGE SIDE)



- **satinato**—tempered glass no extra charge
- **longer execution time** **transparent**—tempered glass no extra charge

**AVAILABLE DOOR FRAMES**



- **[OB3]** block door frame (possibility to add an architrave 10 x 60 mm or 16 x 80 mm) page 87
- **[ORS1]** adjustable door frame with a flat angle architrave 60 mm-wide page 88
- **[ORS8]** adjustable door frame with a flat angle architrave 80 mm-wide page 88
- **[ORS7]** adjustable door frame for modular non-rebated doors with a flat angle architrave 60 mm-wide page 89
- **[ORS10]** adjustable door frame for modular non-rebated doors with a flat angle architrave 80 mm-wide page 89
- **NOTE: THE OFFER ALSO INCLUDES METAL DOOR FRAMES** page 90-91





# collection of **FOILED DOORS**

Salerno.....	54
Norma Decor.....	56
Torino .....	58
Merano .....	60
Lido .....	62
Dolce .....	64
Strada .....	66
Sagittarius.....	68
Gemini .....	70
Virgo .....	72
Parma .....	74
Orso.....	76
Libra .....	78
Taurus.....	78

# Salerno

AVAILABLE OPTIONS OF DOOR LEAVES EXECUTION:



REBATED  
DOORS



SINGLE  
DOORS



DOUBLE  
DOORS



DOORS FOR  
SLIDING  
SYSTEMS



DOORS WITH  
VENTILATION



WATCH THE ASSEMBLY  
VIDEOS ON OUR  
YOUTUBE CHANNEL





**AVAILABLE DECORS**

**ENDURO foil**

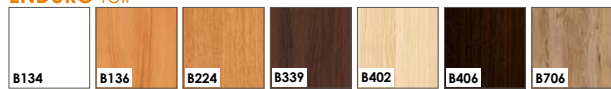

**ENDURO 3D foil**



**ENDURO PLUS foil**



**ECO-VENEER FORTE**



**ECO-VENEER CPL**

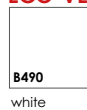

**ENDURO POLI foil**  
Only available as a door frame colour for:

- BLOCK DOOR FRAME,
- ADJUSTABLE DOOR FRAME,
- ADJUSTABLE DOOR FRAME FOR NON-REBATED MODULAR DOORS



**CONSTRUCTION**

- the frame is made of MDF board
  - standard filling—"honeycomb"
  - optional filling—chipboard
  - frame with filling is covered with HDF boards on both sides
  - door leaf covered with ENDURO foil or ECO-VENEER
- side edges and upper edge are foiled
  - rounded vertical edges of door leaves (more info on page 86)
  - in case of double doors, there is a covering strip (drawing on page 86)
  - width of single doors: "60"—"100" / width of double doors: "120"—"200"

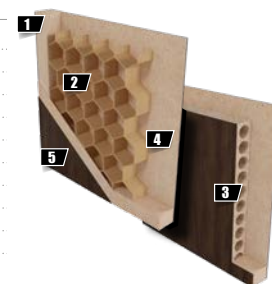

**STANDARD EQUIPMENT**

- lock 72 mm for a standard key, a WC knob, or a cylinder lock insert
- screw-in pivot hinges 13,5/9 (white zinc)—2 pcs for door leaves in sizes "60"—"80", 3 pcs for door leaves in sizes "90" and "100"

**ADDITIONAL OPTIONS AT EXTRA CHARGE**

- door without a key hole no extra charge
- door width "100"
- additional hinge for the door in sizes "60"—"80"
- caps for hinges (chrome, satin chrome, golden, black)
- ventilation undercut
- PVC ventilation sleeves
- metal ventilation sleeves, round (chrome, golden)
- metal ventilation sleeves, square (chrome, nickel)
- door made in a non-rebated version for sliding systems
- double door
- cylinder lock insert 31/36
- tubular chipboard filling
- automatic bottom door seal, widths "60"—"100"
- aluminum thresholds, widths: "60"—"100"

- satinato standard—no extra charge

- [OB3] block door frame (possibility to add an architrave 10 x 60 mm or 16 x 80 mm) page 87
- [ORS1] adjustable door frame with a flat angle architrave 60 mm-wide page 88
- [ORS8] adjustable door frame with a flat angle architrave 80 mm-wide page 88
- NOTE: THE OFFER ALSO INCLUDES METAL DOOR FRAMES page 90-91

**AVAILABLE GLASS** (THE GLOSSY SIDE OF GLASS IS ON THE HINGE SIDE)



**AVAILABLE DOOR FRAMES**



# Norma Decor

AVAILABLE OPTIONS OF DOOR LEAVES EXECUTION:



REBATED  
DOORS



SINGLE  
DOORS



DOUBLE  
DOORS



DOORS FOR  
SLIDING  
SYSTEMS



DOORS WITH  
VENTILATION



WATCH THE ASSEMBLY  
VIDEOS ON OUR  
YOUTUBE CHANNEL







**PORTHOLE in NORMA DECOR 6:**  
available in silver and black colour with the possibility  
of using a transparent or satin glass pane  
**option included in the price of the door leaf**



ND2 and ND3 door leaves are available only in white [B134], beech [B136], oak [B224] and walnut [B339]

### AVAILABLE DECORS

#### ENDURO foil

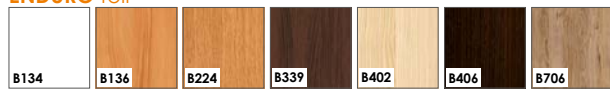

#### ENDURO 3D foil



#### ENDURO PLUS foil



#### ECO-VENEER FORTE



#### ECO-VENEER CPL

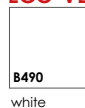

#### ENDURO POLI foil

Only available as a door frame colour for:

- BLOCK DOOR FRAME,
- ADJUSTABLE DOOR FRAME,
- ADJUSTABLE DOOR FRAME FOR NON-REBATED MODULAR DOORS



### CONSTRUCTION

- 1 • the frame is made of MDF board
  - 2 • **standard** filling—"honeycomb"
  - 3 • **optional** filling—chipboard
  - 4 • frame with filling is covered with HDF boards on both sides
  - 5 • door leaf covered with ENDURO foil or ECO-VENEER
- side edges and upper edge are foiled
  - rounded vertical edges of door leaves (**more info on page 86**)
  - in case of double doors, there is a covering strip (**drawing on page 86**)
  - width of single doors: "60"—"100" / width of double doors: "120"—"200"

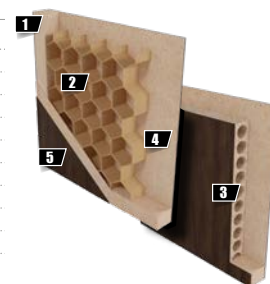

### STANDARD EQUIPMENT

- lock 72 mm for a standard key, a WC knob, or a cylinder lock insert
- **screw-in pivot hinges** 13,5/9 (white zinc)—2 pcs for door leaves in sizes "60"—"80", 3 pcs for door leaves in sizes "90" and "100"

### ADDITIONAL OPTIONS AT EXTRA CHARGE

- door without a key hole **no extra charge**
- door width "100"
- additional hinge for the door in sizes "60"—"80"
- caps for hinges (chrome, satin chrome, golden, black)
- ventilation undercut
- PVC ventilation sleeves
- metal ventilation sleeves, round (chrome, golden)
- metal ventilation sleeves, square (chrome, nickel)
- door made in a non-rebated version for sliding systems
- double door
- cylinder lock insert 31/36
- tubular chipboard filling
- automatic bottom door seal, widths "60"—"100"
- aluminum thresholds, widths: "60"—"100"
- ventilation grid

### AVAILABLE GLASS THE MATT (ENGRAVED) SIDE OF GLASS—ON THE HINGES SIDE



- **chinchila** **standard—no extra charge**
- **satinato** **at extra charge**
- **satinato or transparent—NORMA DECOR 6** **no extra charge**

### AVAILABLE DOOR FRAMES



- **[OB3]** block door frame (possibility to add an architrave 10 x 60 mm or 16 x 80 mm) **page 87**
- **[ORS1]** adjustable door frame with a flat angle architrave 60 mm-wide **page 88**
- **[ORS8]** adjustable door frame with a flat angle architrave 80 mm-wide **page 88**

**NOTE: THE OFFER ALSO INCLUDES METAL DOOR FRAMES**

**page 90–91**

# Torino

AVAILABLE OPTIONS OF DOOR LEAVES EXECUTION:



REBATED  
DOORS



SINGLE  
DOORS



DOUBLE  
DOORS



DOORS FOR  
SLIDING  
SYSTEMS



DOORS WITH  
VENTILATION



WATCH THE ASSEMBLY  
VIDEOS ON OUR  
YOUTUBE CHANNEL





**AVAILABLE DECORS**

**ENDURO foil**

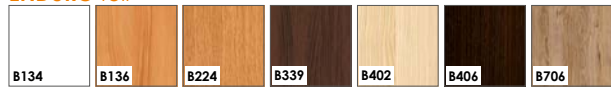

**ENDURO 3D foil**



**ENDURO PLUS foil**



**ECO-VENEER FORTE**



**ECO-VENEER CPL**

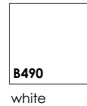

**ENDURO POLI foil**  
Only available as a door frame colour for:

- BLOCK DOOR FRAME,
- ADJUSTABLE DOOR FRAME,
- ADJUSTABLE DOOR FRAME FOR NON-REBATED MODULAR DOORS

**CONSTRUCTION**

- the frame is made of MDF board
  - standard filling—"honeycomb"
  - optional filling—chipboard
  - frame with filling is covered with HDF boards on both sides
  - door leaf covered with ENDURO foil or ECO-VENEER
- side edges and upper edge are foiled
  - rounded vertical edges of door leaves (more info on page 86)
  - in case of double doors, there is a covering strip (drawing on page 86)
  - width of single doors: "60"- "100" / width of double doors: "120"- "200"

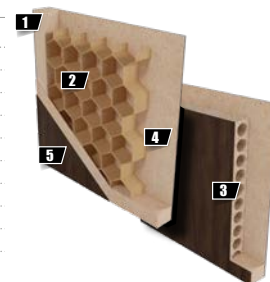

**STANDARD EQUIPMENT**

- lock 72 mm for a standard key, a WC knob, or a cylinder lock insert
- screw-in pivot hinges 13,5/9 (white zinc)—2 pcs for door leaves in sizes "60"- "80", 3 pcs for door leaves in sizes "90" and "100"

**ADDITIONAL OPTIONS AT EXTRA CHARGE**

- door without a key hole no extra charge
- door width "100"
- additional hinge for the door in sizes "60"- "80"
- caps for hinges (chrome, satin chrome, golden, black)
- ventilation undercut
- PVC ventilation sleeves
- metal ventilation sleeves, round (chrome, golden)
- metal ventilation sleeves, square (chrome, nickel)
- door made in a non-rebated version for sliding systems
- double door
- cylinder lock insert 31/36
- tubular chipboard filling
- automatic bottom door seal, widths "60"- "100"
- aluminum thresholds, widths: "60"- "100"

**AVAILABLE GLASS** (THE GLOSSY SIDE OF GLASS IS ON THE HINGE SIDE)



- satinato standard—no extra charge
- chinchila standard—no extra charge

**AVAILABLE DOOR FRAMES**

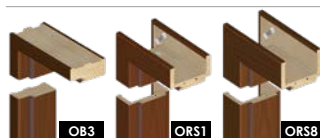

- [OB3] block door frame (possibility to add an architrave 10 x 60 mm or 16 x 80 mm) page 87
  - [ORS1] adjustable door frame with a flat angle architrave 60 mm-wide page 88
  - [ORS8] adjustable door frame with a flat angle architrave 80 mm-wide page 88
- NOTE: THE OFFER ALSO INCLUDES METAL DOOR FRAMES** page 90-91

# Merano

AVAILABLE OPTIONS OF DOOR LEAVES EXECUTION:



REBATED  
DOORS



SINGLE  
DOORS



DOUBLE  
DOORS



DOORS FOR  
SLIDING  
SYSTEMS



DOORS WITH  
VENTILATION



WATCH THE ASSEMBLY  
VIDEOS ON OUR  
YOUTUBE CHANNEL





**AVAILABLE DECORS**

**ENDURO foil**

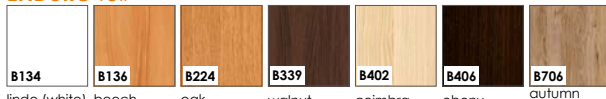

**ENDURO 3D foil**



**ENDURO PLUS foil**



**ECO-VENEER FORTE**



**ECO-VENEER CPL**

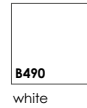

**ENDURO POLI foil**  
Only available as a door frame colour for:

- BLOCK DOOR FRAME,
- ADJUSTABLE DOOR FRAME,
- ADJUSTABLE DOOR FRAME FOR NON-REBATED MODULAR DOORS

**CONSTRUCTION**

- the frame is made of MDF board
  - standard filling—"honeycomb"
  - optional filling—chipboard
  - frame with filling is covered with HDF boards on both sides
  - door leaf covered with ENDURO foil or ECO-VENEER
- side edges and upper edge are foiled
  - rounded vertical edges of door leaves (more info on page 86)
  - in case of double doors, there is a covering strip (drawing on page 86)
  - width of single doors: "60"—"100" / width of double doors: "120"—"200"

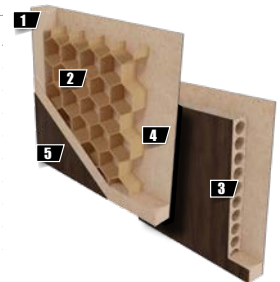

**STANDARD EQUIPMENT**

- lock 72 mm for a standard key, a WC knob, or a cylinder lock insert
- screw-in pivot hinges 13,5/9 (white zinc)—2 pcs for door leaves in sizes "60"—"80", 3 pcs for door leaves in sizes "90" and "100"

**ADDITIONAL OPTIONS AT EXTRA CHARGE**

- door without a key hole no extra charge
- door width "100"
- additional hinge for the door in sizes "60"—"80"
- caps for hinges (chrome, satin chrome, golden, black)
- ventilation undercut
- PVC ventilation sleeves
- metal ventilation sleeves, round (chrome, golden)
- metal ventilation sleeves, square (chrome, nickel)
- door made in a non-rebated version for sliding systems
- double door
- cylinder lock insert 31/36
- tubular chipboard filling
- automatic bottom door seal, widths "60"—"100"
- aluminum thresholds, widths: "60"—"100"

**AVAILABLE GLASS** (THE GLOSSY SIDE OF GLASS IS ON THE HINGE SIDE)

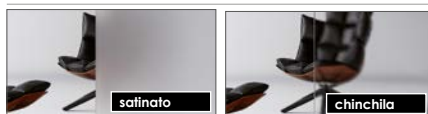

- satinato standard—no extra charge
- chinchila standard—no extra charge

**AVAILABLE DOOR FRAMES**



- OB3 block door frame (possibility to add an architrave 10 x 60 mm or 16 x 80 mm) page 87
- ORS1 adjustable door frame with a flat angle architrave 60 mm-wide page 88
- ORS8 adjustable door frame with a flat angle architrave 80 mm-wide page 88
- NOTE: THE OFFER ALSO INCLUDES METAL DOOR FRAMES page 90–91



REBATED DOORS



SINGLE DOORS



DOUBLE DOORS



DOORS FOR SLIDING SYSTEMS



DOORS WITH VENTILATION



WATCH THE ASSEMBLY VIDEOS ON OUR YOUTUBE CHANNEL





**AVAILABLE DECORS**

**ENDURO foil**

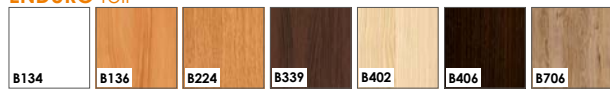

**ENDURO 3D foil**



**ENDURO PLUS foil**



**ECO-VENEER FORTE**



**ECO-VENEER CPL**

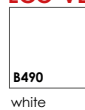

**ENDURO POLI foil**  
Only available as a door frame colour for:

- **BLOCK DOOR FRAME,**
- **ADJUSTABLE DOOR FRAME,**
- **ADJUSTABLE DOOR FRAME FOR NON-REBATED MODULAR DOORS**

**CONSTRUCTION**

- the frame is made of MDF board
- standard** filling—tubular chipboard
- frame with filling is covered with HDF boards on both sides
- door leaf covered with ENDURO foil or ECO-VENEER
  - ALU strip width—8 mm
  - side edges and upper edge are foiled
  - rounded vertical edges of door leaves (**more info on page 86**)
  - in case of double doors, there is a covering strip (**drawing on page 86**)
  - width of single doors: "60"—"100" / width of double doors: "120"—"200"



**STANDARD EQUIPMENT**

- lock 72 mm for standard key, WC knob or cylinder lock insert
- **screw-in pivot hinges** 13.5/9 (white zinc)—2 pcs in door leaves "60"—"80", 3 pcs in door leaves "90"—"100"

**ADDITIONAL OPTIONS AT EXTRA CHARGE**

- door without a key hole no extra charge
- door width "100"
- additional hinge in door width from "60"—"80"
- caps for hinges
- ventilation undercut
- PVC ventilation sleeves
- metal ventilation sleeves, round (chrome, golden)
- metal ventilation sleeves, square (chrome, nickel)
- door made in non-rebated version for sliding systems
- double door
- cylinder lock insert 31/36
- tubular chipboard filling standard
- automatic door bottom seal, widths "60" – "100"
- aluminum thresholds, widths: "60" – "100"

**AVAILABLE DOOR FRAMES**



- **[OB3]** block door frame (possibility to add an architrave 10 x 60 mm or 16 x 80 mm) page 87
- **[ORS1]** adjustable door frame with a flat angle architrave 60 mm-wide page 88
- **[ORS8]** adjustable door frame with a flat angle architrave 80 mm-wide page 88
- **NOTE: THE OFFER ALSO INCLUDES METAL DOOR FRAMES** page 90–91

# Dolce

AVAILABLE OPTIONS OF DOOR LEAVES EXECUTION:



REBATED  
DOORS



SINGLE  
DOORS



DOUBLE  
DOORS



DOORS FOR  
SLIDING  
SYSTEMS



DOORS WITH  
VENTILATION



WATCH THE ASSEMBLY  
VIDEOS ON OUR  
YOUTUBE CHANNEL







**AVAILABLE DECORS**

**ENDURO foil**



**ENDURO 3D foil**

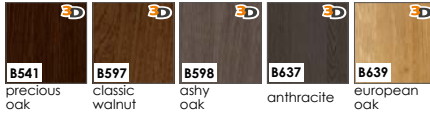

**ENDURO PLUS foil**



**ECO-VENEER FORTE**

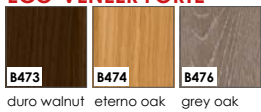

**ECO-VENEER CPL**

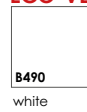

**ENDURO POLI foil**  
Only available as a door frame colour for:

- **BLOCK DOOR FRAMES,**
- **ADJUSTABLE DOOR FRAMES,**
- **ADJUSTABLE DOOR FRAMES FOR NON-REBATED MODULAR DOORS**

**CONSTRUCTION**

- the frame is made of MDF board
  - standard filling—"honeycomb"
  - optional filling—chipboard
  - frame with filling is covered with HDF boards on both sides
  - door leaf covered with ENDURO foil or ECO-VENEER
- side edges and upper edge are foiled
  - rounded vertical edges of door leaves (more info on page 86)
  - in case of double doors, there is a covering strip (drawing on page 86)
  - width of single doors: "60"- "100" / width of double doors: "120"- "200"

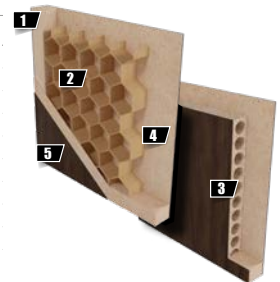

**STANDARD EQUIPMENT**

- lock 72 mm for a standard key, a WC knob, or a cylinder lock insert
- screw-in pivot hinges 13,5/9 (white zinc)—2 pcs for door leaves in sizes "60"- "80", 3 pcs for door leaves in sizes "90" and "100"

**ADDITIONAL OPTIONS AT EXTRA CHARGE**

- door without a key hole no extra charge
- door width "100"
- additional hinge for the door in sizes "60"- "80"
- caps for hinges (chrome, satin chrome, golden, black)
- ventilation undercut
- PVC ventilation sleeves
- metal ventilation sleeves, round (chrome, golden)
- metal ventilation sleeves, square (chrome, nickel)
- door made in a non-rebated version for sliding systems
- double door
- cylinder lock insert 31/36
- tubular chipboard filling
- automatic bottom door seal, widths "60"- "100"
- aluminum thresholds, widths: "60"- "100"

**AVAILABLE GLASS** (THE GLOSSY SIDE OF GLASS IS ON THE HINGE SIDE)



- satinato standard—no extra charge

**AVAILABLE DOOR FRAMES**



- [OB3]** block door frame (possibility to add an architrave 10 x 60 mm or 16 x 80 mm) page 87
- [ORS1]** adjustable door frame with a flat angle architrave 60 mm-wide page 88
- [ORS8]** adjustable door frame with a flat angle architrave 80 mm-wide page 88
- NOTE: THE OFFER ALSO INCLUDES METAL DOOR FRAMES** page 90-91

# Strada

AVAILABLE OPTIONS OF DOOR LEAVES EXECUTION:



REBATED  
DOORS



SINGLE  
DOORS



DOUBLE  
DOORS



DOORS FOR  
SLIDING  
SYSTEMS



DOORS WITH  
VENTILATION



WATCH THE ASSEMBLY  
VIDEOS ON OUR  
YOUTUBE CHANNEL





**AVAILABLE DECORS**

**ENDURO foil**



bidirectional foil (vertical + horizontal)



chestnut



**ENDURO POLI foil**

Only available as a door frame colour for:

- BLOCK DOOR FRAMES,
- ADJUSTABLE DOOR FRAMES,
- ADJUSTABLE DOOR FRAMES FOR NON-REBATED MODULAR DOORS

**ENDURO 3D foil**

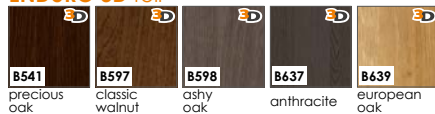

**ENDURO PLUS foil**



**ECO-VENEER FORTE**



**ECO-VENEER CPL**

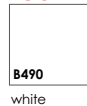

**CONSTRUCTION**

- 1 • the frame is made of MDF board
  - 2 • **standard** filling—"honeycomb"
  - 3 • **optional** filling—chipboard
  - 4 • frame with filling is covered with HDF boards on both sides
  - 5 • door leaf covered with ENDURO foil or ECO-VENEER
- side edges and upper edge are foiled
  - rounded vertical edges of door leaves (**more info on page 86**)
  - in case of double doors, there is a covering strip (**drawing on page 86**)
  - width of single doors: "60"- "100" / width of double doors: "120"- "200"

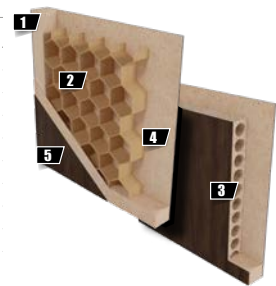

**STANDARD EQUIPMENT**

- lock 72 mm for a standard key, a WC knob, or a cylinder lock insert
- **screw-in pivot hinges** 13,5/9 (white zinc)—2 pcs for door leaves in sizes "60"- "80", 3 pcs for door leaves in sizes "90" and "100"

**ADDITIONAL OPTIONS AT EXTRA CHARGE**

- door without a key hole no extra charge
- door width "100"
- additional hinge for the door in sizes "60"- "80"
- caps for hinges (chrome, satin chrome, golden, black)
- ventilation undercut
- PVC ventilation sleeves
- metal ventilation sleeves, round (chrome, golden)
- metal ventilation sleeves, square (chrome, nickel)
- door made in a non-rebated version for sliding systems
- double door
- cylinder lock insert 31/36
- tubular chipboard filling
- automatic bottom door seal, widths "60"- "100"
- aluminum thresholds, widths: "60"- "100"

**AVAILABLE GLASS** (THE GLOSSY SIDE OF GLASS IS ON THE HINGE SIDE)



- **satinato** standard—no extra charge

**AVAILABLE DOOR FRAMES**

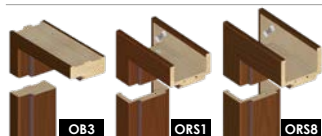

- **[OB3]** block door frame (possibility to add an architrave 10 x 60 mm or 16 x 80 mm) page 87
- **[ORS1]** adjustable door frame with a flat angle architrave 60 mm-wide page 88
- **[ORS8]** adjustable door frame with a flat angle architrave 80 mm-wide page 88
- **NOTE: THE OFFER ALSO INCLUDES METAL DOOR FRAMES** page 90-91

# Sagittarius

AVAILABLE OPTIONS OF DOOR LEAVES EXECUTION:



WATCH THE ASSEMBLY  
VIDEOS ON OUR  
YOUTUBE CHANNEL



Sagittarius 1



Sagittarius 2



Sagittarius 3



**AVAILABLE DECORS**

**ENDURO foil**



bidirectional foil (vertical + horizontal)



**ENDURO POLI foil**  
Only available as a door frame colour for:  
• **BLOCK DOOR FRAMES,**  
• **ADJUSTABLE DOOR FRAMES,**  
• **ADJUSTABLE DOOR FRAMES FOR NON-REBATED MODULAR DOORS**

**ENDURO 3D foil**

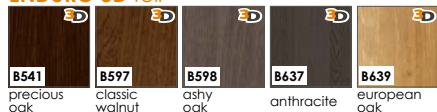

**ENDURO PLUS foil**



**ECO-VENEER FORTE**



**ECO-VENEER CPL**

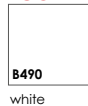

**CONSTRUCTION**

- the frame is made of MDF board
  - standard filling—"honeycomb"
  - optional filling—chipboard
  - frame with filling is covered with HDF boards on both sides
  - door leaf covered with ENDURO foil or ECO-VENEER
- side edges and upper edge are foiled
  - rounded vertical edges of door leaves (more info on page 86)
  - in case of double doors, there is a covering strip (drawing on page 86)
  - width of single doors: "60"—"100" / width of double doors: "120"—"200"

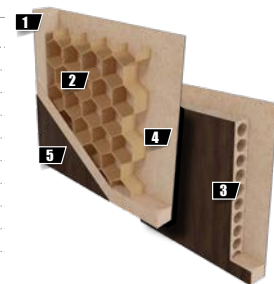

**STANDARD EQUIPMENT**

- lock 72 mm for a standard key, a WC knob, or a cylinder lock insert
- screw-in pivot hinges 13,5/9 (white zinc)—2 pcs for door leaves in sizes "60"—"80", 3 pcs for door leaves in sizes "90" and "100"

**ADDITIONAL OPTIONS AT EXTRA CHARGE**

- door without a key hole no extra charge
- door width "100"
- additional hinge for the door in sizes "60"—"80"
- caps for hinges (chrome, satin chrome, golden, black)
- ventilation undercut
- PVC ventilation sleeves
- metal ventilation sleeves, round (chrome, golden)
- metal ventilation sleeves, square (chrome, nickel)
- door made in a non-rebated version for sliding systems
- double door
- cylinder lock insert 31/36
- tubular chipboard filling
- automatic bottom door seal, widths "60"—"100"
- aluminum thresholds, widths: "60"—"100"

**AVAILABLE GLASS** (THE GLOSSY SIDE OF GLASS IS ON THE HINGE SIDE)



- satinato standard—no extra charge

**AVAILABLE DOOR FRAMES**



- [OB3]** block door frame (possibility to add an architrave 10 x 60 mm or 16 x 80 mm) page 87
  - [ORS1]** adjustable door frame with a flat angle architrave 60 mm-wide page 88
  - [ORS8]** adjustable door frame with a flat angle architrave 80 mm-wide page 88
- NOTE: THE OFFER ALSO INCLUDES METAL DOOR FRAMES** page 90–91

# Gemini

AVAILABLE OPTIONS OF DOOR LEAVES EXECUTION:



REBATED  
DOORS



SINGLE  
DOORS



DOUBLE  
DOORS



DOORS FOR  
SLIDING  
SYSTEMS



DOORS WITH  
VENTILATION



WATCH THE ASSEMBLY  
VIDEOS ON OUR  
YOUTUBE CHANNEL





**AVAILABLE DECORS**

**ENDURO foil**



bidirectional foil (vertical + horizontal)

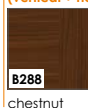

**ENDURO POLI foil**  
Only available as a door frame colour for:

- BLOCK DOOR FRAMES,
- ADJUSTABLE DOOR FRAMES,
- ADJUSTABLE DOOR FRAMES FOR NON-REBATED MODULAR DOORS

[B726] black

**ENDURO 3D foil**



**ENDURO PLUS foil**



**ECO-VENEER FORTE**



**ECO-VENEER CPL**

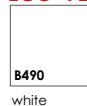

**CONSTRUCTION**

- the frame is made of MDF board
  - standard filling—"honeycomb"
  - optional filling—chipboard
  - frame with filling is covered with HDF boards on both sides
  - door leaf covered with ENDURO foil or ECO-VENEER
- side edges and upper edge are foiled
  - rounded vertical edges of door leaves (more info on page 86)
  - in case of double doors, there is a covering strip (drawing on page 86)
  - width of single doors: "60"—"100" / width of double doors: "120"—"200"

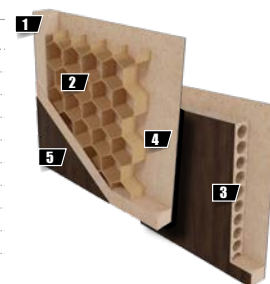

**STANDARD EQUIPMENT**

- lock 72 mm for a standard key, a WC knob, or a cylinder lock insert
- screw-in pivot hinges 13,5/9 (white zinc)—2 pcs for door leaves in sizes "60"—"80", 3 pcs for door leaves in sizes "90" and "100"

**ADDITIONAL OPTIONS AT EXTRA CHARGE**

- door without a key hole no extra charge
- door width "100"
- additional hinge for the door in sizes "60"—"80"
- caps for hinges (chrome, satin chrome, golden, black)
- ventilation undercut
- PVC ventilation sleeves
- metal ventilation sleeves, round (chrome, golden)
- metal ventilation sleeves, square (chrome, nickel)
- door made in a non-rebated version for sliding systems
- double door
- cylinder lock insert 31/36
- tubular chipboard filling
- automatic bottom door seal, widths "60"—"100"
- aluminum thresholds, widths: "60"—"100"

**AVAILABLE GLASS** (THE GLOSSY SIDE OF GLASS IS ON THE HINGE SIDE)



- satinato standard—no extra charge

**AVAILABLE DOOR FRAMES**



- [OB3] block door frame (possibility to add an architrave 10 x 60 mm or 16 x 80 mm) page 87
  - [ORS1] adjustable door frame with a flat angle architrave 60 mm-wide page 88
  - [ORS8] adjustable door frame with a flat angle architrave 80 mm-wide page 88
- NOTE: THE OFFER ALSO INCLUDES METAL DOOR FRAMES** page 90–91



REBATED DOORS



SINGLE DOORS



DOUBLE DOORS



DOORS FOR SLIDING SYSTEMS



DOORS WITH VENTILATION



WATCH THE ASSEMBLY VIDEOS ON OUR YOUTUBE CHANNEL







**AVAILABLE DECORS**

**ENDURO foil**



bidirectional foil (vertical + horizontal)

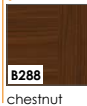

**ENDURO POLI foil**  
Only available as a door frame colour for:

- BLOCK DOOR FRAMES,
- ADJUSTABLE DOOR FRAMES,
- ADJUSTABLE DOOR FRAMES FOR NON-REBATED MODULAR DOORS

**ENDURO 3D foil**



**ENDURO PLUS foil**



**ECO-VENEER FORTE**



**ECO-VENEER CPL**

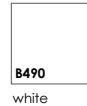

**CONSTRUCTION**

- the frame is made of MDF board
  - standard filling—"honeycomb"
  - optional filling—chipboard
  - frame with filling is covered with HDF boards on both sides
  - door leaf covered with ENDURO foil or ECO-VENEER
- side edges and upper edge are foiled
  - rounded vertical edges of door leaves (more info on page 86)
  - in case of double doors, there is a covering strip (drawing on page 86)
  - width of single doors: "60"—"100" / width of double doors: "120"—"200"

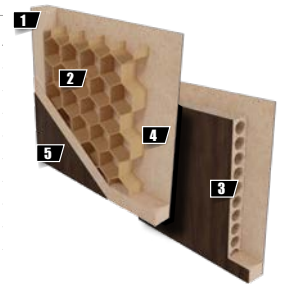

**STANDARD EQUIPMENT**

- lock 72 mm for a standard key, a WC knob, or a cylinder lock insert
- screw-in pivot hinges 13,5/9 (white zinc)—2 pcs for door leaves in sizes "60"—"80", 3 pcs for door leaves in sizes "90" and "100"

**ADDITIONAL OPTIONS AT EXTRA CHARGE**

- door without a key hole no extra charge
- door width "100"
- additional hinge for the door in sizes "60"—"80"
- caps for hinges (chrome, satin chrome, golden, black)
- ventilation undercut
- PVC ventilation sleeves
- metal ventilation sleeves, round (chrome, golden)
- metal ventilation sleeves, square (chrome, nickel)
- door made in a non-rebated version for sliding systems
- double door
- cylinder lock insert 31/36
- tubular chipboard filling
- automatic bottom door seal, widths "60"—"100"
- aluminum thresholds, widths: "60"—"100"

**AVAILABLE GLASS** (THE GLOSSY SIDE OF GLASS IS ON THE HINGE SIDE)



- satinato standard—no extra charge

**AVAILABLE DOOR FRAMES**



- [OB3]** block door frame (possibility to add an architrave 10 x 60 mm or 16 x 80 mm) page 87
  - [ORS1]** adjustable door frame with a flat angle architrave 60 mm-wide page 88
  - [ORS8]** adjustable door frame with a flat angle architrave 80 mm-wide page 88
- NOTE: THE OFFER ALSO INCLUDES METAL DOOR FRAMES** page 90–91

# Parma

AVAILABLE OPTIONS OF DOOR LEAVES EXECUTION:



REBATED  
DOORS



SINGLE  
DOORS



DOUBLE  
DOORS



DOORS FOR  
SLIDING  
SYSTEMS



DOORS WITH  
VENTILATION



WATCH THE ASSEMBLY  
VIDEOS ON OUR  
YOUTUBE CHANNEL





**AVAILABLE DECORS**

**ENDURO foil**

<b>B134</b> lindo (white)	<b>B136</b> beech	<b>B224</b> oak	<b>B339</b> walnut	<b>B402</b> coimbra	<b>B406</b> ebony	<b>B706</b> autumn oak
------------------------------	----------------------	--------------------	-----------------------	------------------------	----------------------	---------------------------

bidirectional foil (vertical + horizontal)

<b>B288</b> chestnut	<b>[B726] black</b>
-------------------------	---------------------

**ENDURO POLI foil**  
Only available as a door frame colour for:

- BLOCK DOOR FRAMES,
- ADJUSTABLE DOOR FRAMES,
- ADJUSTABLE DOOR FRAMES FOR NON-REBATED MODULAR DOORS

**ENDURO 3D foil**

<b>B541</b> precious oak	<b>B597</b> classic walnut	<b>B598</b> ashy oak	<b>B637</b> anthracite	<b>B639</b> european oak	<b>B656</b> italian oak	<b>B657</b> severo oak
-----------------------------	-------------------------------	-------------------------	---------------------------	-----------------------------	----------------------------	---------------------------

unidirectional foil (horizontal)

**ENDURO PLUS foil**

<b>B462</b> cedar forte	<b>B587</b> natura oak	<b>B596</b> snowy oak	<b>B705</b> spring oak	<b>B707</b> winter oak	<b>B708</b> siberian larch
----------------------------	---------------------------	--------------------------	---------------------------	---------------------------	-------------------------------

**ECO-VENEER FORTE**

<b>B473</b> duro walnut	<b>B474</b> eterno oak	<b>B476</b> grey oak
----------------------------	---------------------------	-------------------------

**ECO-VENEER CPL**

<b>B490</b> white
----------------------

**CONSTRUCTION**

- the frame is made of MDF board
  - standard filling—"honeycomb"
  - optional filling—chipboard
  - frame with filling is covered with HDF boards on both sides
  - door leaf covered with ENDURO foil or ECO-VENEER
- side edges and upper edge are foiled
  - rounded vertical edges of door leaves (more info on page 86)
  - in case of double doors, there is a covering strip (drawing on page 86)
  - width of single doors: "60"- "100" / width of double doors: "120"- "200"

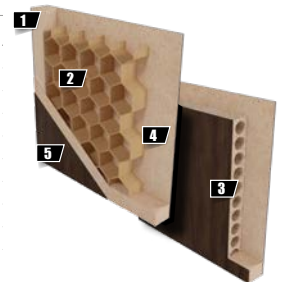

**STANDARD EQUIPMENT**

- lock 72 mm for a standard key, a WC knob, or a cylinder lock insert
- screw-in pivot hinges 13,5/9 (white zinc)—2 pcs for door leaves in sizes "60"- "80", 3 pcs for door leaves in sizes "90" and "100"

**ADDITIONAL OPTIONS AT EXTRA CHARGE**

- door without a key hole **no extra charge**
- door width "100"
- additional hinge for the door in sizes "60"- "80"
- caps for hinges (chrome, satin chrome, golden, black)
- ventilation undercut
- PVC ventilation sleeves
- metal ventilation sleeves, round (chrome, golden)
- metal ventilation sleeves, square (chrome, nickel)
- door made in a non-rebated version for sliding systems
- double door
- cylinder lock insert 31/36
- tubular chipboard filling
- automatic bottom door seal, widths "60"- "100"
- aluminum thresholds, widths: "60"- "100"

**AVAILABLE GLASS** (THE GLOSSY SIDE OF GLASS IS ON THE HINGE SIDE)



- satinato **standard—no extra charge**

**AVAILABLE DOOR FRAMES**



- **[OB3]** block door frame (possibility to add an architrave 10 x 60 mm or 16 x 80 mm) **page 87**
  - **[ORS1]** adjustable door frame with a flat angle architrave 60 mm-wide **page 88**
  - **[ORS8]** adjustable door frame with a flat angle architrave 80 mm-wide **page 88**
- NOTE: THE OFFER ALSO INCLUDES METAL DOOR FRAMES** **page 90-91**



REBATED DOORS



SINGLE DOORS



DOUBLE DOORS



DOORS FOR SLIDING SYSTEMS



DOORS WITH VENTILATION



WATCH THE ASSEMBLY VIDEOS ON OUR YOUTUBE CHANNEL





**AVAILABLE DECORS**

**ENDURO foil**

<b>B134</b> lindo (white)	<b>B136</b> beech	<b>B224</b> oak	<b>B339</b> walnut	<b>B402</b> coimbra	<b>B406</b> ebony	<b>B706</b> autumn oak
------------------------------	----------------------	--------------------	-----------------------	------------------------	----------------------	---------------------------

bidirectional foil (vertical + horizontal)

<b>B288</b> chestnut	<b>[B726] black</b>
-------------------------	---------------------

**ENDURO POLI foil**  
Only available as a door frame colour for:

- BLOCK DOOR FRAMES,
- ADJUSTABLE DOOR FRAMES,
- ADJUSTABLE DOOR FRAMES FOR NON-REBATED MODULAR DOORS

**ENDURO 3D foil**

<b>B541</b> precious oak	<b>B597</b> classic walnut	<b>B598</b> ashy oak	<b>B637</b> anthracite	<b>B639</b> european oak	<b>B656</b> italian oak	<b>B657</b> severo oak
-----------------------------	-------------------------------	-------------------------	---------------------------	-----------------------------	----------------------------	---------------------------

unidirectional foil (horizontal)

**ENDURO PLUS foil**

<b>B462</b> cedar forte	<b>B587</b> natura oak	<b>B596</b> snowy oak	<b>B705</b> spring oak	<b>B707</b> winter oak	<b>B708</b> siberian larch
----------------------------	---------------------------	--------------------------	---------------------------	---------------------------	-------------------------------

**ECO-VENEER FORTE**

<b>B473</b> duro walnut	<b>B474</b> eterno oak	<b>B476</b> grey oak
----------------------------	---------------------------	-------------------------

**ECO-VENEER CPL**

<b>B490</b> white
----------------------

**CONSTRUCTION**

- the frame is made of MDF board
  - standard filling—"honeycomb"
  - optional filling—chipboard
  - frame with filling is covered with HDF boards on both sides
  - door leaf covered with ENDURO foil or ECO-VENEER
- side edges and upper edge are foiled
  - rounded vertical edges of door leaves (more info on page 86)
  - in case of double doors, there is a covering strip (drawing on page 86)
  - width of single doors: "60"—"100" / width of double doors: "120"—"200"

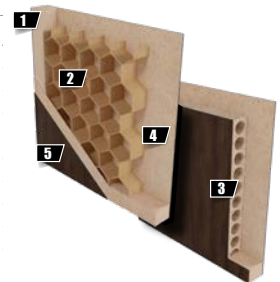

**STANDARD EQUIPMENT**

- lock 72 mm for a standard key, a WC knob, or a cylinder lock insert
- screw-in pivot hinges 13,5/9 (white zinc)—2 pcs for door leaves in sizes "60"—"80", 3 pcs for door leaves in sizes "90" and "100"

**ADDITIONAL OPTIONS AT EXTRA CHARGE**

- door without a key hole no extra charge
- door width "100"
- additional hinge for the door in sizes "60"—"80"
- caps for hinges (chrome, satin chrome, golden, black)
- ventilation undercut
- PVC ventilation sleeves
- metal ventilation sleeves, round (chrome, golden)
- metal ventilation sleeves, square (chrome, nickel)
- door made in a non-rebated version for sliding systems
- double door
- cylinder lock insert 31/36
- tubular chipboard filling
- automatic bottom door seal, widths "60"—"100"
- aluminum thresholds, widths: "60"—"100"

**AVAILABLE GLASS** (THE GLOSSY SIDE OF GLASS IS ON THE HINGE SIDE)



- satinato standard—no extra charge

**AVAILABLE DOOR FRAMES**



- **[OB3]** block door frame (possibility to add an architrave 10 x 60 mm or 16 x 80 mm) page 87
- **[ORS1]** adjustable door frame with a flat angle architrave 60 mm-wide page 88
- **[ORS8]** adjustable door frame with a flat angle architrave 80 mm-wide page 88
- **NOTE: THE OFFER ALSO INCLUDES METAL DOOR FRAMES** page 90–91

# Libra and Taurus

AVAILABLE OPTIONS OF DOOR LEAVES EXECUTION:



REBATED  
DOORS



SINGLE  
DOORS



DOUBLE  
DOORS



DOORS FOR  
SLIDING  
SYSTEMS



DOORS WITH  
VENTILATION



WATCH THE ASSEMBLY  
VIDEOS ON OUR  
YOUTUBE CHANNEL





door leaves TAURUS are available only in CHESTNUT [B288]

**AVAILABLE DECORS**

**ENDURO foil**



**bidirectional foil (vertical + horizontal)**

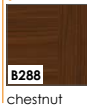

**ENDURO POLI foil**  
Only available as a door frame colour for:

- BLOCK DOOR FRAMES,
- ADJUSTABLE DOOR FRAMES,
- ADJUSTABLE DOOR FRAMES FOR NON-REBATED MODULAR DOORS

**ENDURO 3D foil**



**ENDURO PLUS foil**



**ECO-VENEER FORTE**



**ECO-VENEER CPL**

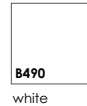

**CONSTRUCTION**

- 1 • the frame is made of MDF board
  - 2 • **standard** filling—"honeycomb"
  - 3 • **optional** filling—chipboard
  - 4 • frame with filling is covered with HDF boards on both sides
  - 5 • door leaf covered with ENDURO foil or ECO-VENEER
- side edges and upper edge are foiled
  - rounded vertical edges of door leaves (**more info on page 86**)
  - in case of double doors, there is a covering strip (**drawing on page 86**)
  - width of single doors: "60"—"100" / width of double doors: "120"—"200"

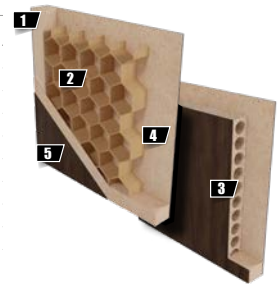

**STANDARD EQUIPMENT**

- lock 72 mm for a standard key, a WC knob, or a cylinder lock insert
- **screw-in pivot hinges** 13,5/9 (white zinc)—2 pcs for door leaves in sizes "60"—"80", 3 pcs for door leaves in sizes "90" and "100"

**ADDITIONAL OPTIONS AT EXTRA CHARGE**

- door without a key hole no extra charge
- door width "100"
- additional hinge for the door in sizes "60"—"80"
- caps for hinges (chrome, satin chrome, golden, black)
- ventilation undercut
- PVC ventilation sleeves
- metal ventilation sleeves, round (chrome, golden)
- metal ventilation sleeves, square (chrome, nickel)
- door made in a non-rebated version for sliding systems
- double door
- cylinder lock insert 31/36
- tubular chipboard filling
- automatic bottom door seal, widths "60"—"100"
- aluminum thresholds, widths: "60"—"100"

**AVAILABLE GLASS** (THE GLOSSY SIDE OF GLASS IS ON THE HINGE SIDE)



- **satinato** standard—no extra charge

**AVAILABLE DOOR FRAMES**



- **[OB3]** block door frame (possibility to add an architrave 10 x 60 mm or 16 x 80 mm) page 87
  - **[ORS1]** adjustable door frame with a flat angle architrave 60 mm-wide page 88
  - **[ORS8]** adjustable door frame with a flat angle architrave 80 mm-wide page 88
- NOTE: THE OFFER ALSO INCLUDES METAL DOOR FRAMES** page 90-91

# Norma Decor and Libra



SINGLE  
DOORS







## AVAILABLE DECORS

### ENDURO foli



### ENDURO 3D foli



### ENDURO PLUS foli



### ECO-VENEER FORTE



### ECO-VENEER CPL

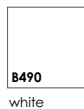

**ENDURO POLI foil**  
Only available as a door frame colour for:

- BLOCK DOOR FRAMES,
- ADJUSTABLE DOOR FRAMES,
- ADJUSTABLE DOOR FRAMES FOR NON-REBATED MODULAR DOORS

## CONSTRUCTION

- folding doors consist of a folding door and a block or adjustable door frame
- 1 • construction of each half of the folding door consists of a frame made of MDF board or 33 mm thick semi-finished coniferous wood glued in layers.
  - 2 • filling—"honeycomb"
  - 3 • frame and filling are covered with 3 mm-thick MDF boards
  - 4 • door leaf covered with ENDURO foil or ECO-VENEER
- each half of a door leaf has a rabbet along the vertical edge
  - both parts of a door leaf are joined together with hidden hinges
  - the door leaf is connected to the floor with a spigot fixed in the holder, which is bolted to the floor
  - the upper part is connected to the door frame with a spigot fixed in the holder, which is mounted in the rail bolted to the upper element of door frame
  - the sliding mechanism (trolley), mounted in the rail, stabilizes the door leaf when opening and closing
  - rounded vertical edges of door leaves (**more info on page 86**)
  - universal door leaf for left or right-hand assembly
  - width of single doors: "60"- "90"

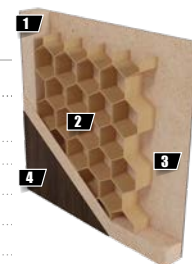

## STANDARD EQUIPMENT

- 2 silver round grips in color silver
- 2 hidden hinges in color silver

- satinato

standard—no extra charge

## AVAILABLE GLASS (THE MATT SIDE OF GLASS IS ON THE HINGE SIDE)



## AVAILABLE DOOR FRAMES



- **[OB3]** block door frame (possibility to add an architrave 10 x 60 mm or 16 x 80 mm) page 87
- **[ORS1]** adjustable door frame with a flat angle architrave 60 mm-wide page 88
- **[ORS8]** adjustable door frame with a flat angle architrave 80 mm-wide page 88

# Pocket door sliding system

AVAILABLE OPTIONS OF DOOR LEAVES EXECUTION:



DIAGRAM OF THE LOCATION OF DOOR FRAME ELEMENTS FOR SLIDING SYSTEM—SINGLE SLIDING SYSTEM

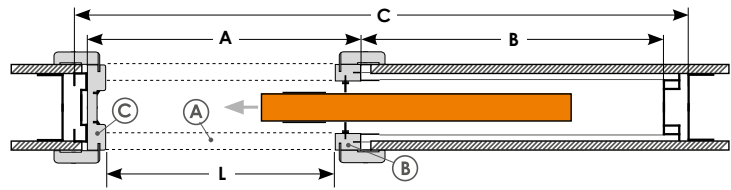
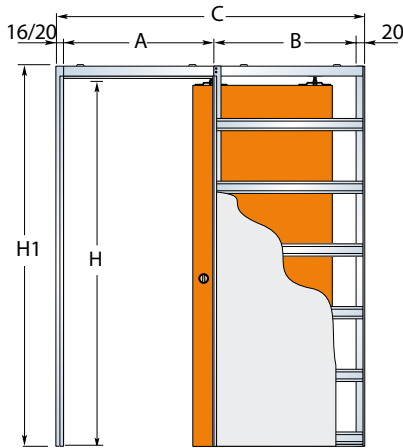

DIMENSIONS OF THE CASSETTE FOR SINGLE SLIDING SYSTEM (mm)				DOOR LEAF DIMENSIONS		
internal width L x H	outer width C x H1	A	B	wall thickness	width	height
610 x 2075 (PL) / 2025 (CZ-SK)	1346 x 2115 (PL) / 2065 (CZ-SK)	670	640	100-125	644	2040 (PL) - 1988 (CZ-SK)
710 x 2075 (PL) / 2025 (CZ-SK)	1546 x 2115 (PL) / 2065 (CZ-SK)	770	740		744	
810 x 2075 (PL) / 2025 (CZ-SK)	1746 x 2115 (PL) / 2065 (CZ-SK)	870	840		844	
910 x 2075 (PL) / 2025 (CZ-SK)	1946 x 2115 (PL) / 2065 (CZ-SK)	970	940		944	
1010 x 2075 (PL) / 2025 (CZ-SK)	2146 x 2115 (PL) / 2065 (CZ-SK)	1070	1040		1044	

H—internal height of cassette; H1—outer height of cassette; L—internal width of cassette; C—outer width of cassette;

DIAGRAM OF THE LOCATION OF DOOR FRAME ELEMENTS FOR SLIDING SYSTEM—DOUBLE SLIDING SYSTEM

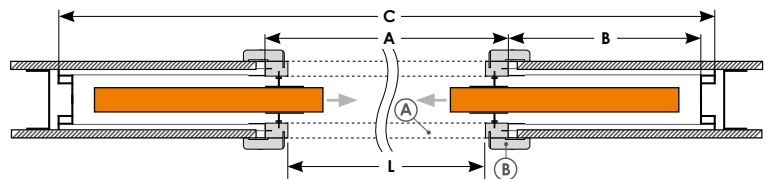
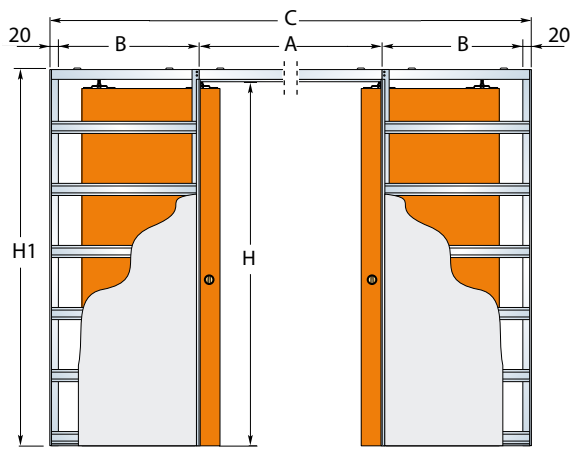

DIMENSIONS OF THE CASSETTE FOR DOUBLE SLIDING SYSTEM (mm)				DOOR LEAF DIMENSIONS		
internal width L x H	outer width C x H1	A	B	wall thickness	width	height
1224 x 2075 (PL) / 2025 (CZ-SK)	2610 x 2115 (PL) / 2065 (CZ-SK)	1290	640	100-125	644	2040 (PL) - 1988 (CZ-SK)
1424 x 2075 (PL) / 2025 (CZ-SK)	3010 x 2115 (PL) / 2065 (CZ-SK)	1490	740		744	
1624 x 2075 (PL) / 2025 (CZ-SK)	3410 x 2115 (PL) / 2065 (CZ-SK)	1690	840		844	
1824 x 2075 (PL) / 2025 (CZ-SK)	3810 x 2115 (PL) / 2065 (CZ-SK)	1890	940		944	
2024 x 2075 (PL) / 2025 (CZ-SK)	4210 x 2115 (PL) / 2065 (CZ-SK)	2090	1040		1044	

H—internal height of cassette; H1—outer height of cassette; L—internal width of cassette; C—outer width of cassette;

DIAGRAM OF LOCATION OF DOOR FRAME ENLARGING ELEMENTS FOR THE SLIDING DOOR POCKET SYSTEM

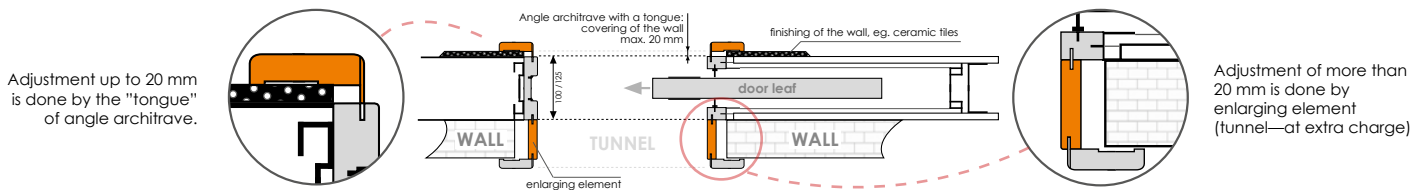

CASSETTE ELEMENTS: (A—upper profile + angle architrave / B—vertical profile + angle architrave / C—fender beam + angle architrave)

Dimensions of cassette elements (mm)	a1	a2	a3	a4	b1	b2	b3	b4	c1	c2	c3	c4	c5
cassette 100	19	(PL) 50 / 60 (CZ-SK)	25	10	19	(PL) 33 / 40 (CZ-SK)	7	10	25	7	(PL) 50 / 60 (CZ-SK)	12	(PL) 2073 / 2023 (CZ-SK)
cassette 125	25												

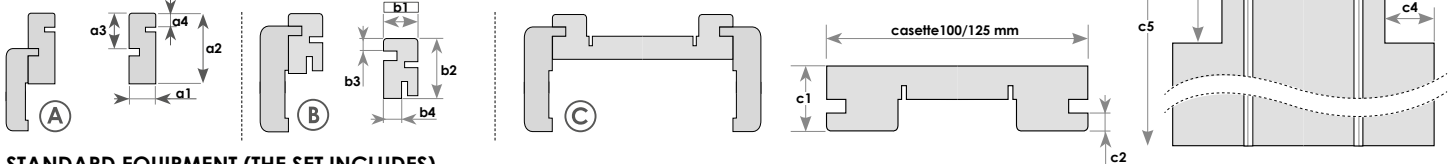

STANDARD EQUIPMENT (THE SET INCLUDES)

- construction cassette for sliding system in sizes "100" or "125"
- set of profiles (door frame), brushes and seals
- set of covering profiles for both sides of the door frame
- grip (chrome, satin, golden or black)

ADDITIONAL OPTIONS AT EXTRA CHARGE

- soft-close hardware for sliding door
- key hook lock or WC hook lock (chrome, satin, golden, black) with a grip suitable for key or WC lock. In case of door leaves equipped with a hook lock, the customer installs the striking plate in the door frame on their own
- tunnel (door frame enlarging element)—price per each 10 mm
- strike plate

The cassette 100 mm-wide is designed for modular door leaves (eg. Domino, Versano, Tamparo) and standard flat doors NORMA DECOR 1 and TAURUS. The cassette 125 mm-wide is designed for standard foiled door leaves (eg Torino, Strada).



# Wall-mounted sliding system

AVAILABLE OPTIONS OF DOOR LEAVES EXECUTION:



WATCH ON OUR  
YOUTUBE CHANNEL:  
**ASSEMBLY AND  
INSTALLATION OF  
WALL-MOUNTED  
SLIDING SYSTEM**



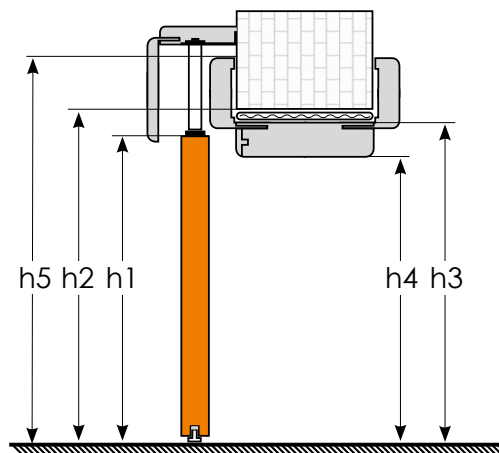
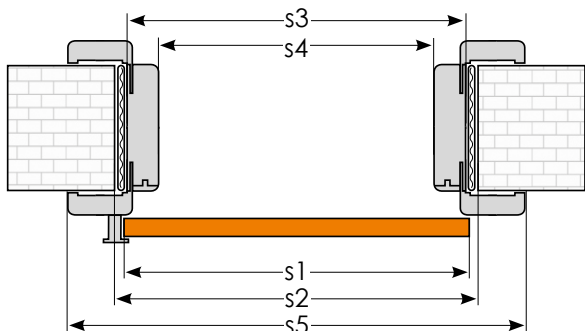

**DIMENSIONS OF DOOR LEAF AND DOOR FRAME FOR ON-WALL SLIDING SYSTEM (mm)**

		door frame for the single door					door frame for the double door									
		"60"	"70"	"80"	"90"	"100"	"120"	"130"	"140"	"150"	"160"	"170"	"180"	"190"	"200"	
s1	door leaf width	644	744	844	944	1044	1288	1388	1488	1588	1688	1788	1888	1988	2088	
s2	width of the wall opening*	674	774	874	974	1074	1294	1394	1494	1594	1694	1794	1894	1994	2094	
s3	outer width of the door frame	644	744	844	944	1044	1264	1364	1464	1564	1664	1764	1864	1964	2064	
s4	internal width of the door frame	600	700	800	900	1000	1220	1320	1420	1520	1620	1720	1820	1920	2020	
s5	width of the door frame with architraves	60 mm [ORS3]	744	844	944	1044	1364	1464	1564	1664	1764	1864	1964	2064	2164	
		80 mm [ORS9]	784	884	984	1084	1184	1404	1504	1604	1704	1804	1904	2004	2104	2204
h1	door leaf height	(PL) 2040 / 1988 (CZ-SK)														
h2	height of the wall opening	(PL) 2062 / 2008 (CZ-SK)														
h3	outer height of the door frame	(PL) 2047 / 1993 (CZ-SK)														
h4	internal height of the door frame*	(PL) 2025 / 1971 (CZ-SK)														
h5	height of the door frame with architraves	60 mm [ORS3]	(PL) 2097 / 2043 (CZ-SK)													
		80 mm [ORS9]	(PL) 2117 / 2063 (CZ-SK)													

\*Dimensions of the wall opening for the version without a door frame should be identical to the internal width of the door frame.

**CLASSIFICATION OF RAILS AND RAIL COVERS DEPENDING ON THE WIDTH OF THE SLIDING SYSTEM**

door leaf	length of rail cover	number of rails and angle architraves	door leaf	length of rail cover	number of rails and angle architraves
"60"	1350 mm	1 rail and angle architrave 200 cm-long	"70" + "70" or "60" + "80"	3000 mm	2 rails and angle architraves 200 cm-long
"70"	1550 mm		"70" + "80" or "60" + "90"	3200 mm	
"80"	1750 mm		"80" + "80" or "70" + "90" lub "60" + "100"	3400 mm	
"90"	1950 mm		"80" + "90" or "70" + "100"	3600 mm	
"100"	2150 mm		"90" + "90" or "80" + "100"	3800 mm	
"60" + "60"	2600 mm	2 rails and angle architraves 200 cm-long	"90" + "100"	4000 mm	
"60" + "70"	2800 mm		"100" + "100"	4200 mm	3 rails and angle architraves 200 cm-long

**STANDARD EQUIPMENT (THE SET INCLUDES)**

- rail cover in the door leaf decor—installed on ALU strip (two types, depending on the width of the masking angle architrave used in the door frame—60 mm or 80 mm)
- rail—installed on ALU strip
- thimble—1 piece (chrome, satin, golden)
- grip—chrome, satin, golden, black—a set for both sides of door leaf and thimble—1 piece (chrome, satin, golden, black)



**ADDITIONAL OPTIONS AT EXTRA CHARGE**

- soft-close hardware for sliding door
- bumper
- key hook lock or WC hook lock (chrome, satin, golden, black) with a grip suitable for key or WC lock

- ENDURO / PLUS / 3D
- ECO-VENEER
- KEY
- WC lock



rail cover



soft-close hardware for sliding door



bumper

**AVAILABLE DOOR FRAMES**



- [ORS3] adjustable door frame with a flat angle architrave 60 mm-wide the set includes: door frame and bumper with milling and striking plate
- [ORS9] adjustable door frame with a flat angle architrave 80 mm-wide the set includes: door frame and bumper with milling and striking plate

# Dimensions

## DIMENSIONS OF REBATED DOORS

	"60"	"70"	"80"	"90"	"100"
A	618	718	818	918	1018
B	644	744	844	944	1044
C	(PL) 2027 / 1975 (CZ-SK)				
D	(PL) 2040 / 1988 (CZ-SK)				

DIMENSIONS A AND C ARE OUTER DIMENSIONS OF NON-REBATED DOORS AND DOORS PREPARED FOR SLIDING SYSTEMS

## Contact edges for double doors

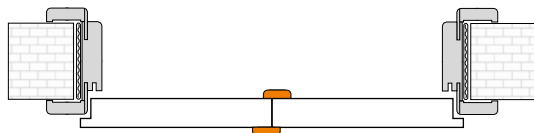

**MODULAR OR FLAT REBATED DOORS WITH BLOCK OR ADJUSTABLE DOOR FRAME**  
COVERING STRIPS ON BOTH SIDES OF THE DOOR

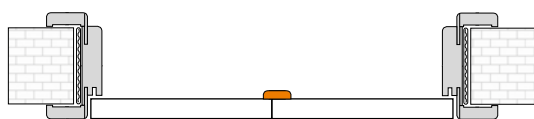

**MODULAR NON-REBATED DOORS WITH ADJUSTABLE DOOR FRAME**  
COVERING STRIP ON THE DOOR FRAME SIDE

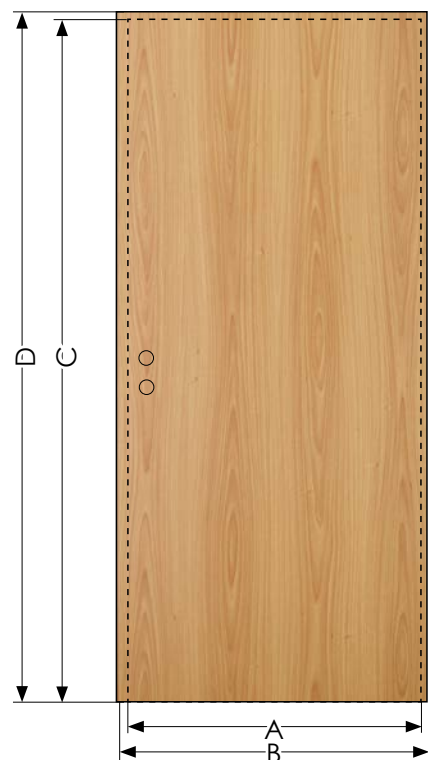

## Rounded vertical and upper edges in door leaves

DOORS	STANDARD DOORS		SLIDING SYSTEMS	EDGE FROM THE CONTACT SIDE OF DOUBLE DOOR
	REBATED	NON-REBATED		
MODULAR DOORS	YES	YES	YES	YES
FLAT DOORS	YES		NO	NO
FOLDING DOORS	YES*			

\*OUTER VERTICAL EDGES ONLY.

## Ventilation

According to the norm, the door to the bathroom, shower and separate WC should open outwards, have the passage width of at least 0.8 m and height of 2 m, and have the ventilation holes for the air supply in the bottom of the door with total ventilation area of at least 0.022 m<sup>2</sup>. The total ventilation area is the sum of the gap under the door (standard 7 mm) and additional solutions that increase the total net ventilation area such as: ventilation sleeves, ventilation undercut and ventilation grid. The use of ventilation grid ensures the correct ventilation area for all door widths, while using the sleeve and/or undercut the increased gap between the door and the floor should be used in order to meet the required regulations. If regulations mentioned above must be obliged, the clients must trim the door on their own.

### GUIDELINES FOR BUILDINGS EQUIPPED WITH A RECUPERATION SYSTEM

To ensure adequate air flow from the living areas to the corridor, sanitary, and auxiliary rooms, it is recommended that all internal doors should have a gap at the bottom. The gap area in doors in living and auxiliary rooms should be at least 80 cm<sup>2</sup> (INVADO doors with an undercut fully meet this requirement). The size of the ventilation gap in doors in sanitary rooms should be 200 cm<sup>2</sup>.



ventilation undercut



ventilation grid (Norma Decor)



round or square ventilation sleeves

door width	number of ventilation sleeves	door leaf with metal ventilation sleeves	door leaf with PVC ventilation sleeves for foiled doors	door leaf with PVC ventilation sleeves for modular doors	total ventilation area: ventilation undercut and the gap under the door (7 mm) [m <sup>2</sup> ]	total ventilation area: ventilation grid and the gap under the door (7 mm) [m <sup>2</sup> ]
		total ventilation area: ventilation sleeves and the gap under the door (7 mm) [m <sup>2</sup> ]	total ventilation area: ventilation sleeves and the gap under the door (7 mm) [m <sup>2</sup> ]	total ventilation area: ventilation sleeves and the gap under the door (7 mm) [m <sup>2</sup> ]		
"60"	3	0,0069	0,0062	0,0056	0,00835	> 0,022
"70"	4	0,0085	0,0075	0,0067	0,01085	
"80"	5	0,0101	0,0089	0,0079	0,01335	
"90"	6	0,0117	0,0103	0,0090	0,01585	
"100"	6	0,0124	0,0110	0,0097	0,01835	
"110"	6	0,0131	0,0117	0,0104	0,02085	

DOOR COLLECTIONS WHERE THE VENTILATION SLEEVES, VENTILATION UNDERCUT AND VENTILATION GRID CANNOT BE USED: D'ARTAGNAN COLLECTION. THERE IS NO POSSIBILITY TO SIMULTANEOUSLY USE MORE SOLUTIONS FOR VENTILATION IN INVADO DOORS.

# OB3 Block door frame for rebated doors

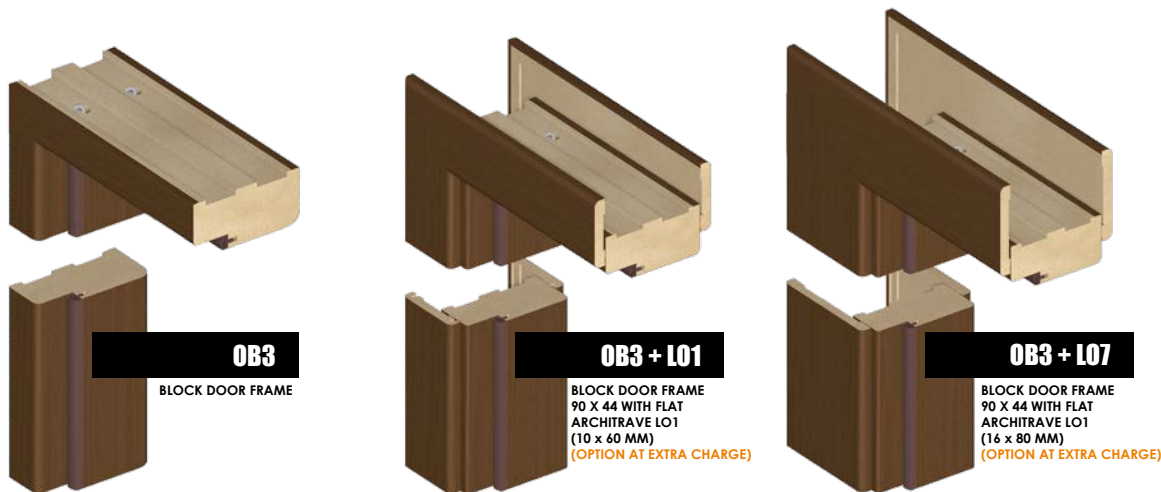

### CONSTRUCTION

- MDF board
- foiling—all decors available in the INVADO offer
- cross-section: 90 x 44 mm

### DOOR FRAME FOR DOOR LEAVES IN WIDTH

- width of single doors "60" to "100"
- width of double doors "120" to "200"

### OPTIONS AT EXTRA CHARGE FOR BLOCK DOOR FRAMES

- flat architrave LO1 60 x 10 mm
- flat architrave LO7 80 x 10 mm
- quadrant LC1
- door frames with sidelights and transoms (without glass) with circumference up to 5.1m
- door frames for double doors
- additional hinge in door frame "60"-"80"

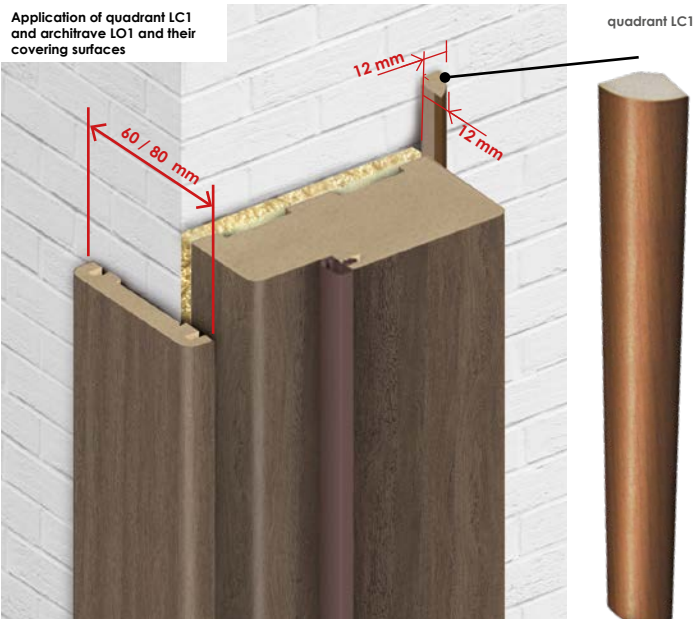

COVERING TRIMS (LO1) AND QUADRANT (LC1) CAN BE APPLIED TO A BLOCK DOOR FRAME FOR DOOR LEAVES IN WIDTHS "60"-"90". IN CASE OF DOOR LEAVES IN WIDTH "100" YOU HAVE TO ORDER DOUBLE COVERING TRIM OR DOUBLE QUADRANT (LC2).

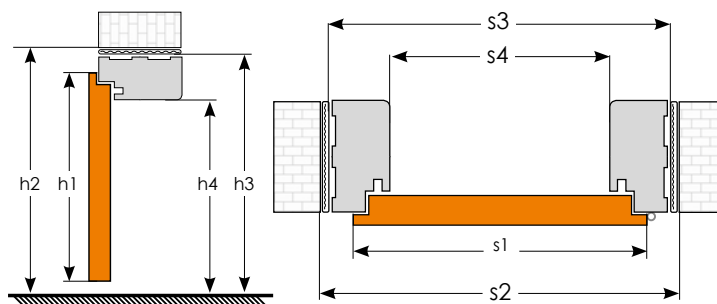

### DIMENSIONS OF DOOR LEAF AND DOOR FRAME

		single door					double door								
door leaf:		"60"	"70"	"80"	"90"	"100"	"120"	"130"	"140"	"150"	"160"	"170"	"180"	"190"	"200"
s1	door leaf width	644	744	844	944	1044	1264	1364	1464	1564	1664	1764	1864	1964	2064
s2	width of the wall opening	718	818	918	1018	1118	1338	1438	1538	1638	1738	1838	1938	2038	2138
s3	outer width of the door frame	688	788	888	988	1088	1308	1408	1508	1608	1708	1808	1908	2008	2108
s4	internal width of the door frame	600	700	800	900	1000	1220	1320	1420	1520	1620	1720	1820	1920	2020
h1	door leaf height	(PL) 2040 / 1987 (CZ-SK)													
h2	height of the wall opening	(PL) 2084 / 2029 (CZ-SK)													
h3	outer height of the door frame	(PL) 2069 / 2014 (CZ-SK)													
h4	internal height of the door frame	(PL) 2025 / 1970 (CZ-SK)													

# DOOR FRAMES

ORS1 / ORS8

## Adjustable door frame for rebated doors

ADJUSTABLE  
DOOR  
FRAME  
INSTALLATION

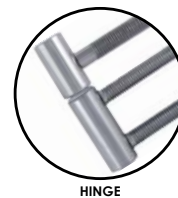
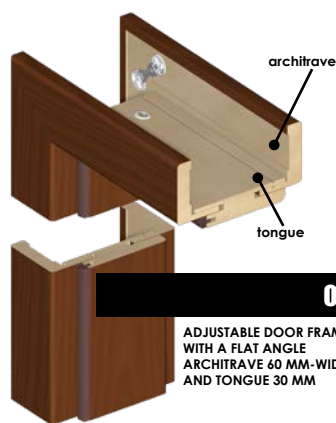

### CONSTRUCTION

- MDF board
- foiling—all decors available in the INVADO offer
- standard adjustable door frame consists of central element plus 2 sets of angle architraves joined at 45°. Standard angle architrave consists of a flat architrave 60 mm-wide and a "tongue" 30 mm-long. There is a possibility to order:
  - a) adjustable door frame with a flat angle architrave 80 mm-wide (ORS8).
  - b) a set of flat angle architraves 60 mm or 80 mm-wide with a "tongue" 50 mm-long (sold separately). See the table of options at extra charge.

### OPTIONS AT EXTRA CHARGE FOR ADJUSTABLE DOOR FRAMES

- door frames with sidelights and transoms (without glass) with circumference up to 5 l.m
- door frames for double doors
- additional hinge in door frame "60"- "80"
- standard angle architrave (a "tongue" 30 mm-long, an architrave 60 or 80 mm-wide)
- angle architrave with longer "tongue" (a "tongue" 50 mm-long, an architrave 60 or 80 mm-wide)
- wall framing ("blind door frame")

### DOOR FRAME FOR DOOR LEAVES IN WIDTH

- width of single doors "60" to "100"
- width of double doors "120" to "200"

### RANGES OF WALL THICKNESS COVERING

- Adjustable door frame is made in dimensions adjustable to the wall thickness in steps of 20 mm. The minimum wall thickness is 75 mm. **NOTE: due to special mills there is a possibility to trim the frame and reduce the wall thickness coverage by 15 mm.** Door frame for the wall thickness greater than 340 mm consists of at least two connected components.

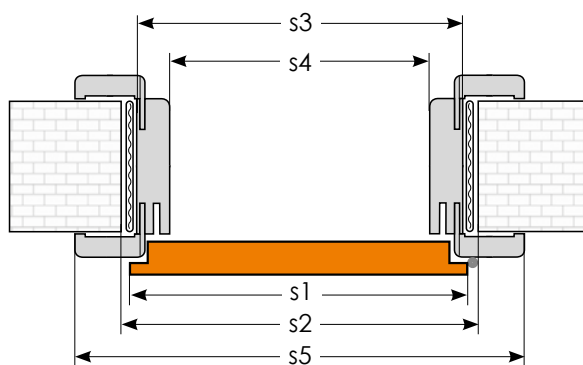
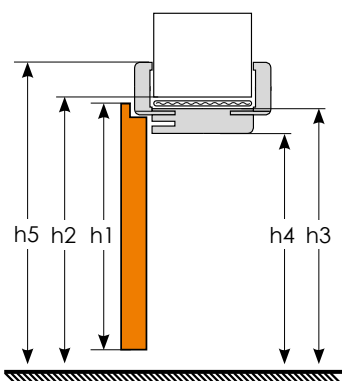

MODIFICATION OF  
DOOR FRAME WIDTH

### DIMENSIONS OF DOOR LEAF AND DOOR FRAME

door leaf:		single door					double door									
		"60"	"70"	"80"	"90"	"100"	"120"	"130"	"140"	"150"	"160"	"170"	"180"	"190"	"200"	
s1	door leaf width	644	744	844	944	1044	1264	1364	1464	1564	1664	1764	1864	1964	2064	
s2	width of the wall opening	674	774	874	974	1074	1294	1394	1494	1594	1694	1794	1894	1994	2094	
s3	outer width of the door frame	644	744	844	944	1044	1264	1364	1464	1564	1664	1764	1864	1964	2064	
s4	internal width of the door frame	600	700	800	900	1000	1220	1320	1420	1520	1620	1720	1820	1920	2020	
s5	width of the door frame with architraves	60 mm [ORS1]	744	844	944	1044	1144	1364	1464	1564	1664	1764	1864	1964	2064	2164
		80 mm [ORS8]	784	884	984	1084	1184	1404	1504	1604	1704	1804	1904	2004	2104	2204
h1	door leaf height	(PL) 2040 / 1988 (CZ-SK)														
h2	height of the wall opening	(PL) 2062 / 2008 (CZ-SK)														
h3	outer height of the door frame	(PL) 2047 / 1993 (CZ-SK)														
h4	internal height of the door frame	(PL) 2025 / 1971 (CZ-SK)														
h5	height of the door frame with architraves	60 mm [ORS1]	(PL) 2097 / 2043 (CZ-SK)													
		80 mm [ORS8]	(PL) 2117 / 2063 (CZ-SK)													

### NOMINAL COVERAGE OF THE WALL FOR ADJUSTABLE DOOR FRAMES

symbol	A	B	C	D	E	F	G	H	I	J	
wall thickness	75–94	95–114	120–139	140–159	160–179	180–199	200–219	220–239	240–259	260–279	
symbol	K	L	M	N	O	P	Q	R	S	T	U
wall thickness	280–299	300–319	320–339	340–359	360–379	380–399	400–419	420–439	440–459	460–479	480–499*

\*It is possible to order adjustable door frame thicker than 499 mm—for this purpose please contact with INVADO's commercial department



# ORS7/ ORS10 Adjustable door frame for non-rebated modular doors

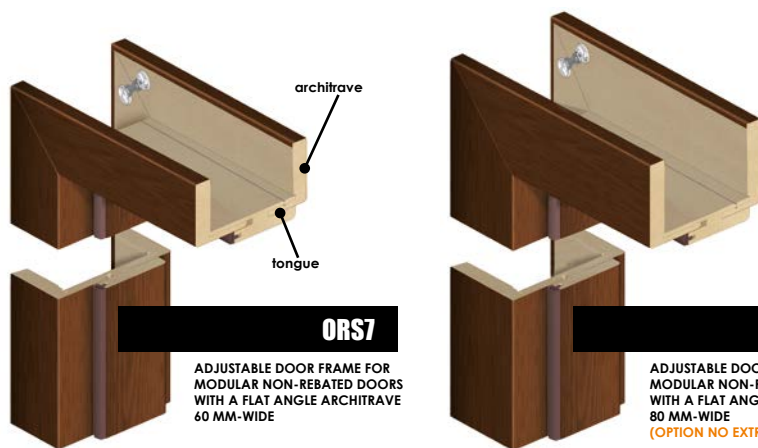

HIDDEN HINGE WITH 3D REGULATION (NON-REBATED DOORS)

**ORS7**  
ADJUSTABLE DOOR FRAME FOR MODULAR NON-REBATED DOORS WITH A FLAT ANGLE ARCHITRAVE 60 MM-WIDE

**ORS10**  
ADJUSTABLE DOOR FRAME FOR MODULAR NON-REBATED DOORS WITH A FLAT ANGLE ARCHITRAVE 80 MM-WIDE (OPTION NO EXTRA CHARGE)

## CONSTRUCTION

- MDF board
- foiling—all decors available in the INVADO offer
- standard adjustable door frame consists of central element plus 2 sets of angle architraves joined at 45°. Standard angle architrave consists of a flat architrave 60 mm-wide and a "tongue" 30 mm-long. There is a possibility to order:
  - a) adjustable door frame with a flat angle architrave 80 mm-wide (ORS10)
  - b) a set of angle architraves 60 mm or 80 mm-wide with a "tongue" 50 mm-long (sold separately). See the table of options at extra charge

## OPTIONS AT EXTRA CHARGE FOR ADJUSTABLE NON-REBATED MODULAR DOORS

- door frames with sidelights and transoms (without glass) with circumference up to 5 l.m
- door frames for double doors
- additional hinge in door frame
- standard angle architrave (a "tongue" 30 mm-long, an architrave 60 or 80 mm-wide)
- angle architrave with longer "tongue" (a "tongue" 50 mm-long, an architrave 60 or 80 mm-wide)

## DOOR FRAME FOR DOOR LEAVES IN WIDTH

- width of single doors "60" to "100"
- width of double doors "120" to "200"

## RANGES OF WALL THICKNESS COVERING

- Adjustable door frame is made in dimensions adjustable to the wall thickness in steps of 20 mm. The minimum wall thickness is 75 mm. **NOTE: due to special mills there is a possibility to trim the frame and reduce the wall thickness coverage by 15 mm.** Door frame for the wall thickness greater than 340 mm consists of at least two connected components.

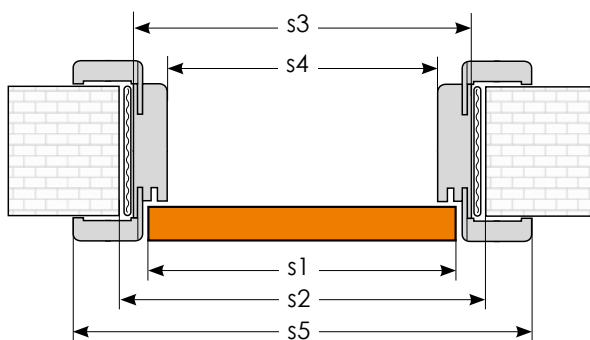
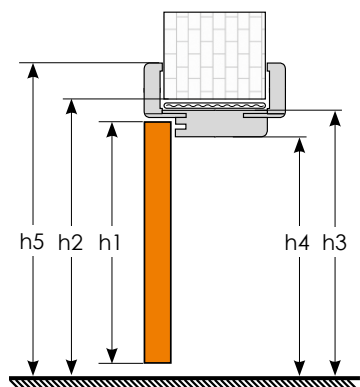

MODIFICATION OF DOOR FRAME WIDTH

## DIMENSIONS OF DOOR LEAF AND DOOR FRAME

door leaf:		single door					double door									
		"60"	"70"	"80"	"90"	"100"	"120"	"130"	"140"	"150"	"160"	"170"	"180"	"190"	"200"	
s1	door leaf width	618	718	818	918	1018	1239	1339	1439	1539	1639	1739	1839	1939	2039	
s2	width of the wall opening	674	774	874	974	1074	1294	1394	1494	1594	1694	1794	1894	1994	2094	
s3	outer width of the door frame	644	744	844	944	1044	1264	1364	1464	1564	1664	1764	1864	1964	2064	
s4	internal width of the door frame	600	700	800	900	1000	1220	1320	1420	1520	1620	1720	1820	1920	2020	
s5	width of the door frame with architraves	60 mm [ORS7]	744	844	944	1044	1144	1364	1464	1564	1664	1764	1864	1964	2064	2164
		80 mm [ORS10]	784	884	984	1084	1184	1404	1504	1604	1704	1804	1904	2004	2104	2204
h1	door leaf height	(PL) 2027 / 1975 (CZ-SK)														
h2	height of the wall opening	(PL) 2062 / 2008 (CZ-SK)														
h3	outer height of the door frame	(PL) 2047 / 1993 (CZ-SK)														
h4	internal height of the door frame	(PL) 2025 / 1971 (CZ-SK)														
h5	height of the door frame with architraves	60 mm [ORS7]	(PL) 2097 / 2043 (CZ-SK)													
		80 mm [ORS10]	(PL) 2117 / 2063 (CZ-SK)													

## NOMINAL COVERAGE OF THE WALL FOR ADJUSTABLE DOOR FRAMES

symbol	A	B	C	D	E	F	G	H	I	J	
wall thickness	75–94	95–114	120–139	140–159	160–179	180–199	200–219	220–239	240–259	260–279	
symbol	K	L	M	N	O	P	Q	R	S	T	U
wall thickness	280–299	300–319	320–339	340–359	360–379	380–399	400–419	420–439	440–459	460–479	480–499*

\*It is possible to order adjustable door frame thicker than 499 mm—for this purpose please contact with INVADO's commercial department



**CONSTRUCTION**

- welded frame
- ungalvanized plate with a thickness of 1,2 mm
- powder-coated frame in a choice of standard RAL colours
- 2 hinges in color white zinc and a seal included
- universal mounting brackets for brick walls and plasterboard walls

**DOOR FRAME FOR DOOR LEAVES IN WIDTH**

- width of single doors "60" to "110"
- width of double doors "120" to "200"

**RANGES OF WALL THICKNESS COVERING**

- door frame **FD11**—75 mm
- door frame **FD12**—100 mm

**DIMENSIONS OF DOOR LEAF AND DOOR FRAME FD11 AND FD12**

	single door					double door									
	"60"	"70"	"80"	"90"	"100"	"120"	"130"	"140"	"150"	"160"	"170"	"180"	"190"	"200"	
s1	door leaf width	644	744	844	944	1044	1264	1364	1464	1564	1664	1764	1864	1964	2064
s2	width of the wall opening	670	770	870	970	1070	1290	1390	1490	1590	1690	1790	1890	1990	2090
s3	outer width of the door frame	696	796	896	996	1096	1316	1416	1516	1616	1716	1816	1916	2016	2116
s4	internal width of the door frame	600	700	800	900	1000	1220	1320	1420	1520	1620	1720	1820	1920	2020
h1	door leaf height	2040													
h2	height of the wall opening	2037													
h3	outer height of the door frame	2072													
h4	internal height of the door frame	2024													

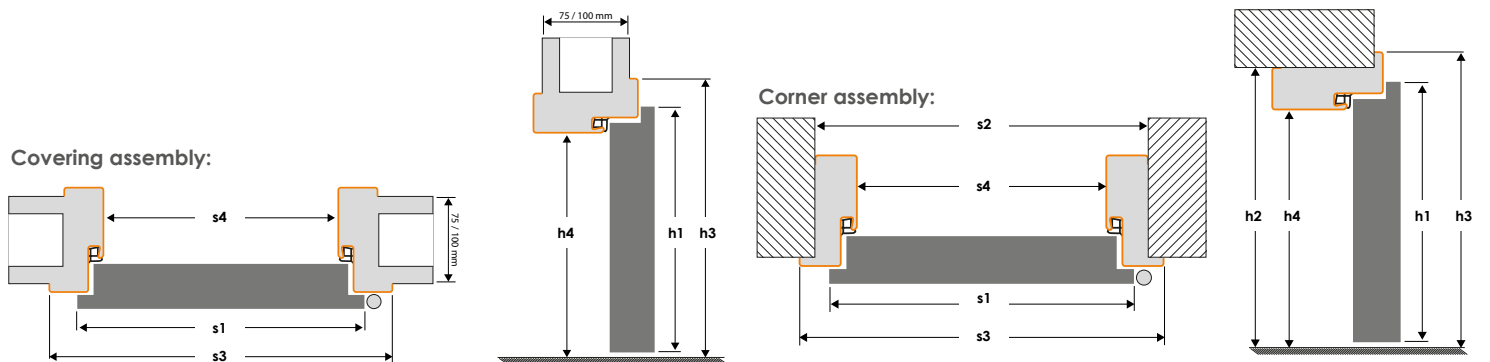

**OPTIONS AT EXTRA CHARGE FOR METAL DOOR FRAMES**

- reinforcement for the self-closer
- adapted for electric door strike

AVAILABLE DECORS RAL: 9010—white / 9016—white / 8017—chocolate brown / 7047—gray / 7024—graphite / 1001—beige

**FD 14**

# Metal door frame (small)

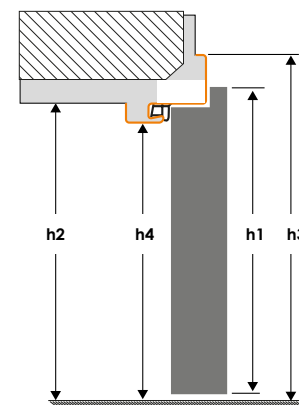
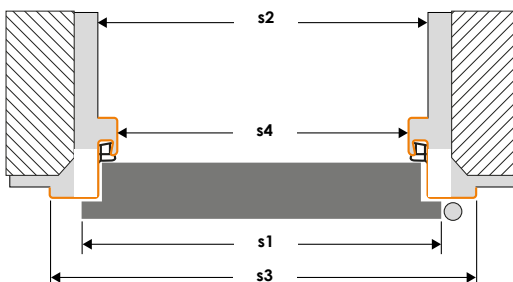
**CONSTRUCTION**

- welded frame
- ungalvanized plate with a thickness of 1,2 mm
- powder-coated frame in a choice of standard RAL colours
- 2 hinges in white zinc and seal included
- universal mounting brackets for brick walls and plasterboard walls

**DOOR FRAME FOR DOOR LEAVES IN WIDTH**

- width of single doors "60" to "110"
- width of double doors "120" to "200"

**DIMENSIONS OF DOOR LEAF AND DOOR FRAME FD14**

	single door					double door									
	"60"	"70"	"80"	"90"	"100"	"120"	"130"	"140"	"150"	"160"	"170"	"180"	"190"	"200"	
s1	door leaf width	644	744	844	944	1044	1264	1364	1464	1564	1664	1764	1864	1964	2064
s2	width of the wall opening	661	761	861	961	1061	1281	1381	1481	1581	1681	1781	1881	1981	2081
s3	outer width of the door frame	696	796	896	996	1096	1316	1416	1516	1616	1716	1816	1916	2016	2116
s4	internal width of the door frame	600	700	800	900	1000	1220	1320	1420	1520	1620	1720	1820	1920	2020
h1	door leaf height	2040													
h2	height of the wall opening	2038													
h3	outer height of the door frame	2072													
h4	internal height of the door frame	2024													

**FD 61–67**

# Adjustable metal door frame

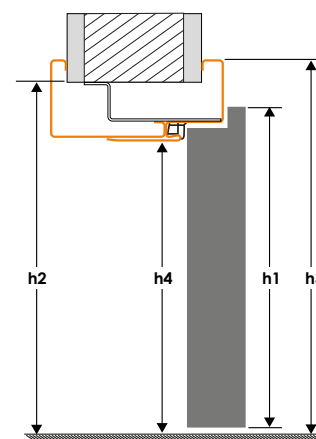
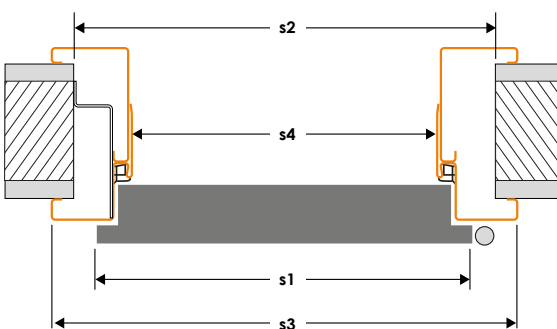
**CONSTRUCTION**

- 2-part frame, adjustable (adjustment range in 30 mm steps)
- ungalvanized plate with a thickness of 1,5 mm
- powder-coated frame in a choice of standard RAL colours
- 3 hinges in color white zinc and seal included
- universal mounting brackets for brick walls and plasterboard walls

**DOOR FRAME FOR DOOR LEAVES IN WIDTH**

- width of single doors "60" to "110"
- width of double doors "120" to "200"

**RANGES OF WALL THICKNESS COVERING**

door frame:	FD61	FD62	FD63	FD64	FD65	FD66	FD67
ranges:	95–125	125–155	155–185	185–215	215–245	245–275	275–305

**DIMENSIONS OF DOOR LEAF AND DOOR FRAME ADJUSTABLE METAL DOOR FRAME**

	single door					double door									
	"60"	"70"	"80"	"90"	"100"	"120"	"130"	"140"	"150"	"160"	"170"	"180"	"190"	"200"	
s1	door leaf width	644	744	844	944	1044	1264	1364	1464	1564	1664	1764	1864	1964	2064
s2	width of the wall opening	683	783	883	983	1083	1300	1400	1500	1600	1700	1800	1900	2000	2100
s3	outer width of the door frame	716	816	916	1016	1116	1334	1434	1534	1634	1734	1834	1934	2034	2134
s4	internal width of the door frame	600	700	800	900	1000	1220	1320	1420	1520	1620	1720	1820	1920	2020
h1	door leaf height	2040													
h2	height of the wall opening	2065													
h3	outer height of the door frame	2082													
h4	internal height of the door frame	2024													

# Concealed door frame SARA-PRO



NON-REBATED DOOR LEAF FOR OUTER DOOR FRAME AND REBATED DOOR LEAF FOR INNER DOOR FRAME  
BASED ON DOOR LEAF NORMA DECOR 1

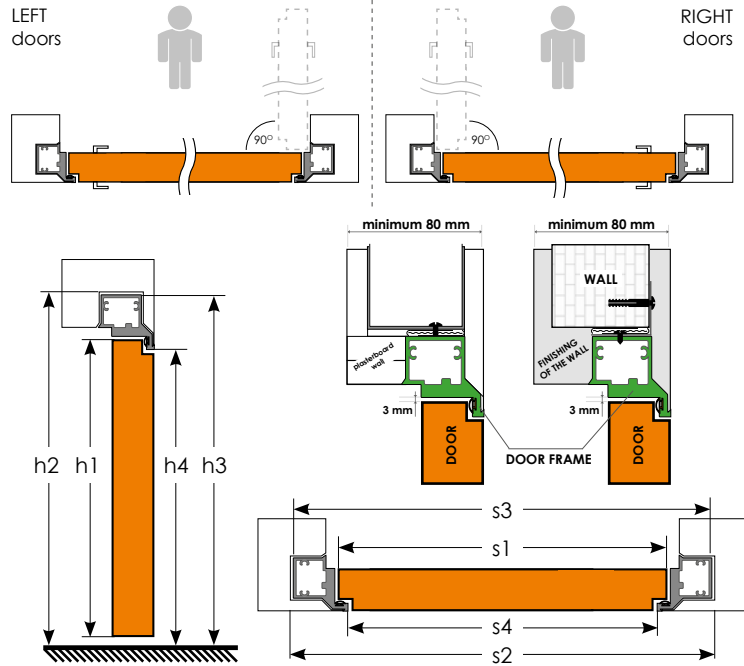
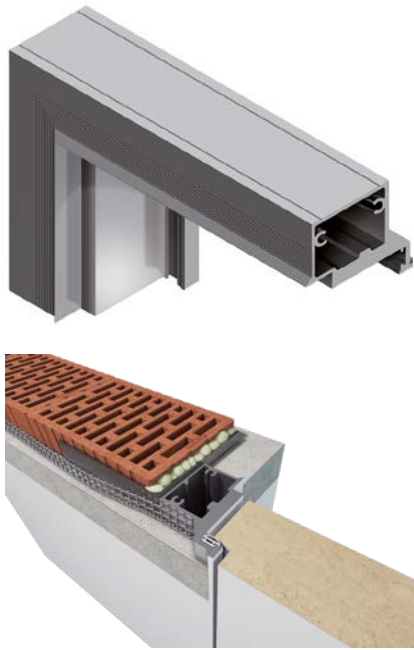

CONCEALED DOOR FRAME SARA-PRO—OUTER

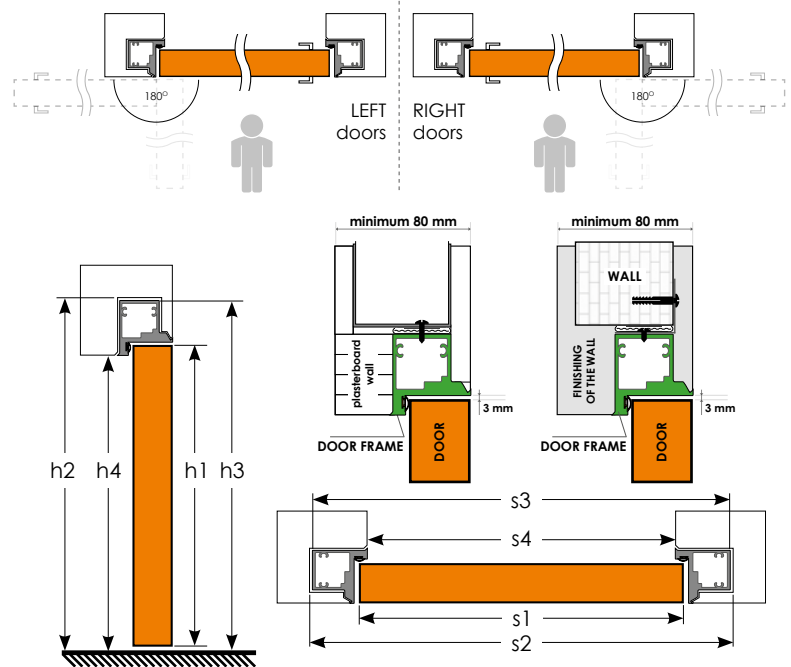

The Sara Pro Door frame introduces a completely new quality in interior decoration. Invisible to the naked eye, it makes the area lighter. Ideal for minimalist and modern interiors. Available in outer and inner version.

**CONSTRUCTION**

- the frame is made of MDF board
- the surface and edges of a door leaf are primed and prepared for painting or wallpapering (painting and wallpapering on your own)
- filling—„honeycomb“ or tubular chipboard (optionally)
- frame with filling is covered with HDF boards on both sides
- width of single doors "60"—"90"

**STANDARD EQUIPMENT OF A DOOR LEAF**

- 2 hidden hinges
- magnetic lock for standard key, WC knob or cylinder lock insert

**ADDITIONAL OPTIONS AT EXTRA CHARGE**

- door without a key hole no extra charge
- ventilation undercut
- PVC ventilation sleeves
- cylinder lock insert 31/36
- filling—tubular chipboard
- automatic door bottom seal for door width "60"—"90"
- ventilation grid

**DIMENSIONS OF A DOOR LEAF AND CONCEALED DOOR FRAME**

inner door frame	"60"	"70"	"80"	"90"
s1 door leaf width	618	718	818	918
s2 width of the wall opening	698	798	898	998
s3 outer width of the door frame	688	788	888	988
s4 internal width of the door frame	603	703	803	903
h1 door leaf height	(PL) 2027 / 1975 (CZ/SK)			
h2 height of the wall opening	(PL) 2076 / 2024 (CZ/SK)			
h3 outer height of the door frame	(PL) 2069 / 2017 (CZ/SK)			
h4 ernal height of the door frame	(PL) 2027 / 1975 (CZ/SK)			
outer door frame	"60"	"70"	"80"	"90"
s1 door leaf width	618	718	818	918
s2 width of the wall opening	698	798	898	998
s3 outer width of the door frame	688	788	888	988
s4 internal width of the door frame	603	703	803	903
h1 door leaf height	(PL) 2017 / 1965 (CZ/SK)			
h2 height of the wall opening	(PL) 2066 / 2014 (CZ/SK)			
h3 outer height of the door frame	(PL) 2059 / 2007 (CZ/SK)			
h4 ernal height of the door frame	(PL) 2017 / 1965 (CZ/SK)			

ATTENTION:  
It's possible to paint SARA-PRO door frame with a wall paint after previously coating it with a primer paint included in the package

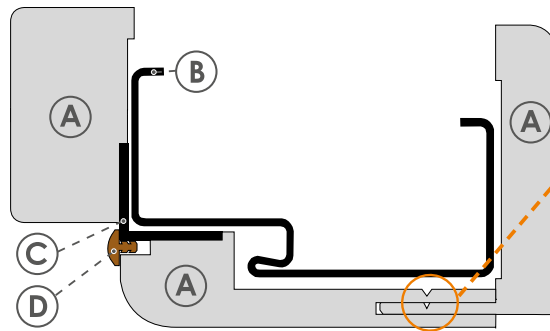
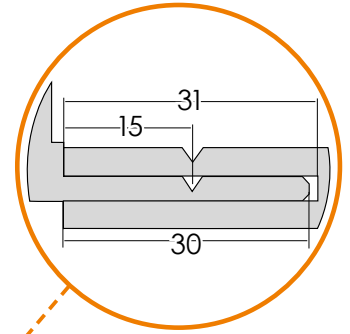

- (A) door frame housing
- (B) metal door frame
- (C) aluminium angle element
- (D) gasket

**FEATURES**

Metal frame housing (covering) allows to install new doors in the rooms where metal frames were mounted in accordance with the Polish standard (regarding dimensions) without having to remove these frames. The advantage of this solution is an easy installation with mounting foam, without dirty floors and walls, and the ability to mount a standard foiled INVADO door leaves.

**WIDTH OF THE DOOR FRAME FOR DOOR LEAVES**

- width of single doors "60" to "100"

**RANGES OF WALL THICKNESS**

- 60-94, 95-129, 130-199, 200-269

**INTERNAL DIMENSIONS OF METAL DOOR FRAME (mm)**

door leaf:		"60"	"70"	"80"	"90"
s1	door leaf width	600	700	800	900
h1	door leaf height	(PL) 2025 / 1975 (CZ/SK)			

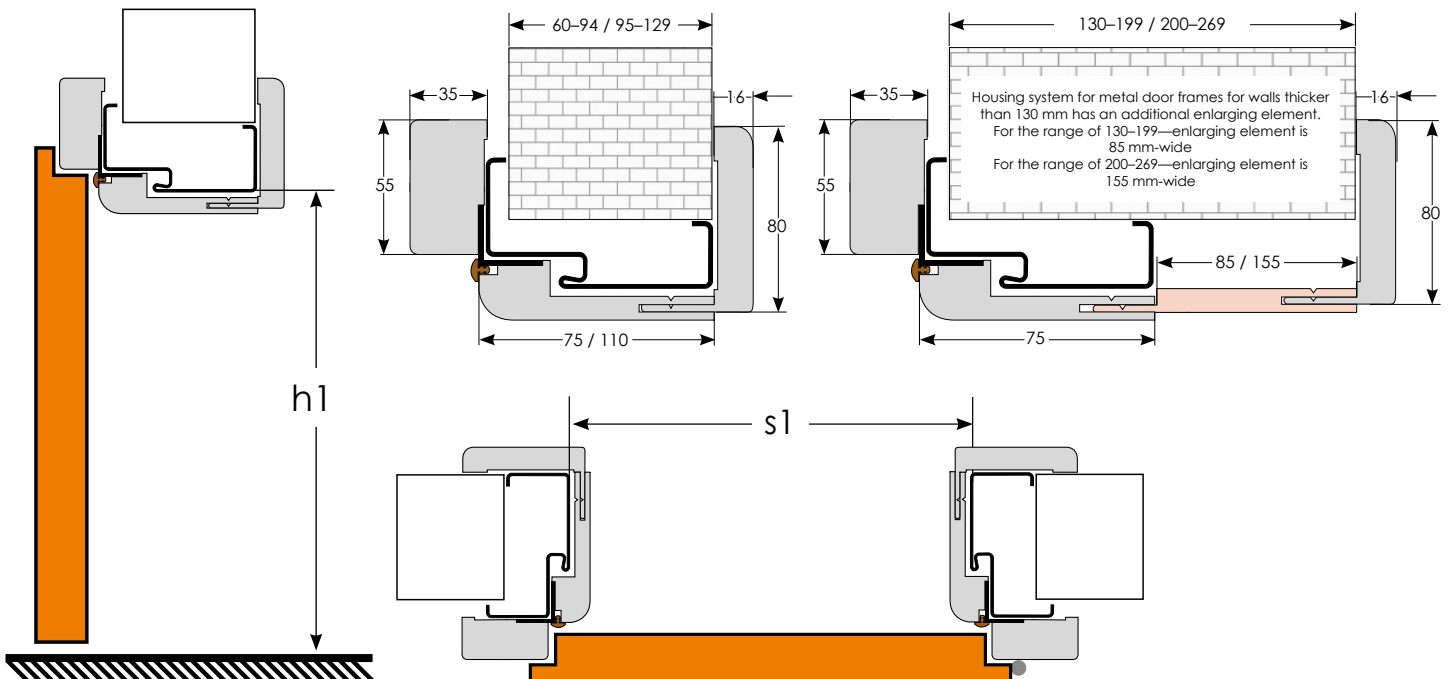

# Foiled and modular doors

<p><b>caps for hinges</b> (satinated chrome, chrome, black or golden)</p>	<p><b>hinge</b></p>	<p><b>hidden hinge</b> (non-rebated doors)</p>	<p><b>cylinder lock insert</b></p>	<p><b>ventilation sleeves</b> (round/square)</p>
<p><b>automatic bottom door seal</b></p>	<p><b>porthole</b> (black or silver with satinated or transparent glass)</p>	<p><b>ventilation grid</b></p>	<p><b>aluminum threshold</b></p>	
<p><b>door seal (package 5,5 m)</b> colours: BLACK / WHITE / GRAY / BROWN / BEIGE</p>			<p><b>self-closer</b></p>	

# Sliding systems

<p><b>key hook lock WC \ KEY</b></p>	<p><b>grip with folding key, thimble and striking plate</b></p>	<p><b>grip with WC knob, thimble and striking plate</b></p>	<p><b>grip and thimble</b></p>	<p><b>strike plate</b></p>	<p><b>soft-close hardware for sliding door</b></p>
<p><b>door seal</b> (pocket door sliding system)</p>	<p><b>profiles and architraves</b> (pocket door sliding system)</p>	<p><b>brush</b> (pocket door sliding system)</p>	<p><b>bumper</b> (wall-mounted sliding system)</p>	<p><b>rail cover</b> (wall-mounted sliding system)</p>	

# KICK and PUSH metal panels

- material: polished stainless steel
- dimensions: width matched to the door leaf, height 300 mm, thickness 0,6 mm
- ventilation undercut—height: 15 mm
- ventilation sleeves—diameter: 40 mm (depending on the width of the door leaf, a different number of ventilation sleeves are used: "60"—3 sleeves / "70"—4 sleeves / "80"—5 sleeves / "90"—"100"—6 sleeves)
- ventilation grid—dimensions: 430 x 110 mm

<p><b>KICK/PUSH bottom panel with handle holes</b></p>	<p><b>KICK bottom panel with ventilation undercut</b></p>
<p><b>KICK bottom panel with ventilation sleeves</b></p>	<p><b>KICK bottom panel with ventilation grid</b></p>



# HANDLES



**NEW**

handle **SPIGOLA-QR**  
photo: matt copper

Escutcheons:



- matt golden
- matt copper
- glossy chrome
- matt chrome
- black



**NEW**

handle **FOSTER-BI**  
photo: glossy golden



- glossy chrome
- matt nickel
- white
- glossy gold
- black



handle **DUO**  
photo: graphite/chrome



- satin nickel/chrome
- graphite/chrome



handle **ENTRA**  
photo: anthracite/chrome



- satin nickel/chrome
- anthracite/chrome



handle **FLIP**  
photo: anthracite/chrome



- satin nickel/chrome
- anthracite/chrome



handle **EUFORIO**  
photo: black



- black



handle **SPARK FIT**  
photo: black



- black



handle **SAPHIRE**  
photo: stainless steel



- stainless steel



Escutcheons:



handle **SPARK**  
photo: satin nickel



satin nickel

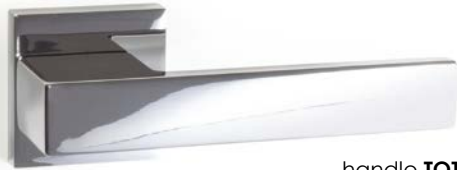

handle **TOTAL-Q**  
photo: glossy chrome



matt chrome  
 glossy chrome  
 black



**NEW**

handle **SPLASH**  
photo: black



glossy chrome  
 matt chrome  
 black



**NEW**

handle **VIOLA**  
photo: glossy chrome



glossy chrome  
 matt chrome  
 glossy gold  
 black



handle **GIUSSY**  
photo: nickel/chrome



nickel/chrome  
 brown gratiatio



handle **INVADO**  
photo: nickel/chrome



nickel/chrome



handle **PRESTO**  
photo: nickel/chrome



nickel/chrome



handle **UNO-R**  
photo: stainless steel



stainless steel



handle **UNO**  
photo: stainless steel

Standard Key  
Escutcheon

Euro Key  
Escutcheon

Bathroom Thumbturn  
Escutcheon

stainless steel

# Prestige

WATCH ON OUR YOUTUBE CHANNEL

**PRESTIGE  
SKIRTINGS  
INSTALLATION**



## model P124



dimension (mm): **100 x 16 x 2400**

available decors:

white primer foil B145 (for painting)

ENDURO foil

ECO-VENEER



## model P125



dimension (mm): **60 x 16 x 2400**

available decors:

white primer foil B145 (for painting)

ENDURO foil—white B134



## model P127



dimension (mm): **110 x 16 x 2400**

available decors:

white primer foil B145 (for painting)

ENDURO foil—white B134

**ADDITIONAL OPTIONS AT EXTRA CHARGE**

- finishing element 20 x 20 x 120 mm
- clips—30 pcs/package

Skirting length—240 cm. Skirtings are packed 5 pcs/package. The price is for 1 piece



clip



finishing element

**model P129 / P402 / P403**

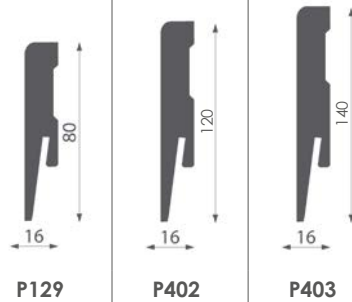

available decors:

**white primer foil B145 (for painting)**

**ENDURO foil:** profiles P402 and P403 available only in B134 decor

**ECO-VENEER**



**model P130**



dimension (mm): **100 x 16 x 2400**

available decors:

**white primer foil B145 (for painting)**

**ENDURO foil—white B134**



**model P132**



dimension (mm): **100 x 16 x 2400**

available decors:

**white primer foil B145 (for painting)**

**ENDURO foil—white B134**





## EXPORT MANAGERS:

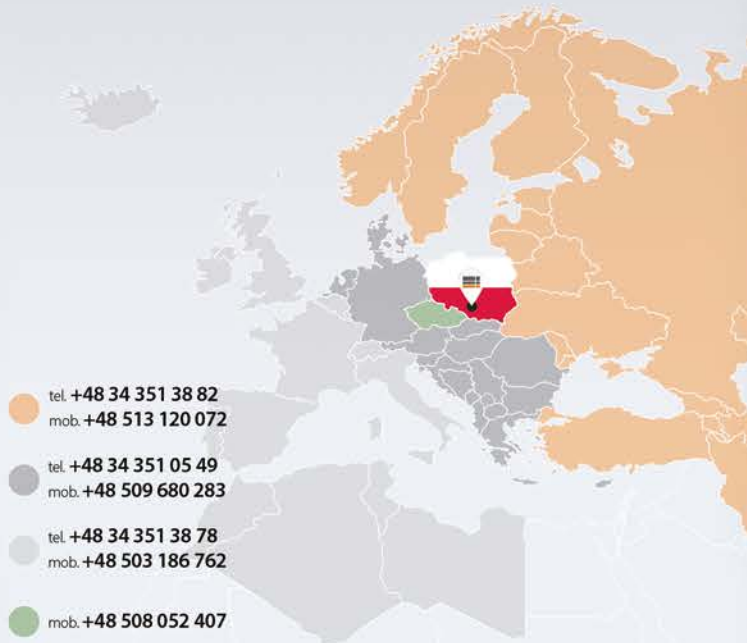

tel. +48 34 351 38 82  
mob. +48 513 120 072

tel. +48 34 351 05 49  
mob. +48 509 680 283

tel. +48 34 351 38 78  
mob. +48 503 186 762

mob. +48 508 052 407

### INVADO Sp. z o.o.

Dzielna, ul. Leśna 2  
42-793 Ciasna, Polska

e-mail: [biuro@invado.pl](mailto:biuro@invado.pl)

tel. +48 34 351 05 40

fax +48 34 353 56 02

SCAN AND READ



ON YOUR MOBILE DEVICE

## ARBONIA Group

All information in the catalogue do not constitute an offer within the meaning of the Civil Code and are published for informational purposes only. Manufacturer reserves the right to make changes.

Note! Due to the printing technique the colors of the products presented in the catalogue may differ from the original. All rights reserved. Copying and publication of this catalogue on web sites and in other media without the written consent from INVADO Sp. z o.o. is prohibited.

Distributor's stamp: